

43

AGR

Auto Glass
Tools and Hardware

Truck, Van, RV and
Automotive Windows

CRL[®]

crlaurence.com

Page intentionally
left blank





To Our Valued Customers

We would like to say "Thank You" to all of our customers and employees. Your help and encouragement has made it possible for C.R. Laurence Company to grow into the industry leader, and we plan to continue growing. Our goal is to listen, and challenge ourselves to better serve our customers.

Because of you we set our standards for innovation, service, and selection of quality products at the highest level. We consider it our responsibility to bring new technology to our industry so that we can all prosper.

We believe the Internet is the tool of the future, and C.R. Laurence Company is making a major commitment to the development of our web site to be your source for information and technical support. Access to all CRL products and services is available to you at crlaurence.com, the most comprehensive and convenient information source we can offer our customers.

The CRL web site is a powerful communications device between your business and the CRL people who serve you. It also allows us to empower you to have more flexibility and control of your orders, making it possible for you to contribute in the process of our providing you with excellent service. We invite you to visit us at crlaurence.com.

This catalog is the latest evidence of our commitment to bring you the finest and most comprehensive product line and services for auto glass businesses. We consider this to be a publication that makes an important contribution to the knowledge and training of the auto glass industry. We are proud to make it available to you.

This will be the first in a series of six Master Catalogs that we are working on to serve the glass industry. Each catalog will focus on our core business groups. See page III for more information.

CRL's success has been made possible through our transition into manufacturing. We are producing a growing number of products to fill all of your requirements, and we will continue to listen to your ideas for products to manufacture for our industry. As always, we plan to expand our product line to be a continuing source for the glass industry. We are also adding to the number of distribution facilities we use to serve you, with plans for more to come.

Again, we thank you for your continued support. Without your ideas for better service, new products, and generally high expectations, we would not have enjoyed our growth and success. Let's continue our success together.

Donald E. Friese
President and C.E.O.



Lloyd W. Talbert
Executive Vice President



C.R. Laurence Canada

C.R. Laurence Canada has four locations to serve all of Canada from coast-to-coast. We invite our customers in Canada to turn to page XVI for more information.



C.R. Laurence is a Catalog Company

- Master and Specialty Catalogs in Print, on CD-ROM, and Online
- Thousands of Products Presented in an Organized Manner
- Color Photos and Detailed Illustrations
- Easy to Understand Ordering Information

Of all the products we bring you, our catalogs may be the most important. C.R. Laurence is in the business of making catalogs because we know that the most efficient way for our customers to shop at CRL is through carefully planned and thoroughly prepared catalogs that make it easy for them to find exactly what they need.

Part of our catalog philosophy is to bring you more of the information you need, and not overburden you with excess catalog literature. That is why we make our Master Catalogs that usually contain all of the products we offer to certain industries, as well as our Specialty Catalogs that focus on particular product groups. You can select CRL Catalogs for only the areas that pertain to your business, or choose to shop from our Master Catalogs because you like the convenience of finding such a wide variety of products all under one cover. Most other suppliers, with their 'all or nothing' catalog policies don't offer you this level of convenience.

We make a concerted effort to create attractive, efficient, and easy to use catalogs that accurately present the thousands of products CRL offers. With so many items available through our network of distribution centers, it is absolutely imperative that we make it easy for you to select and order them. It does us no good to manufacture or buy and stock such an extensive inventory if we don't make it available to our customers in a manner that makes your buying from CRL a simple and pleasant experience. We know that if CRL does a good job making it easier for you to find and buy the products your business uses then you will have more time to do the things that make you money. For more information on CRL Catalogs, please see the next page, or visit our web site at crlaurence.com.



Free CRL Catalogs Online

You can also view or download CRL Catalogs free of charge any time at crlaurence.com. Go to the Home Page and click on the button for the CRL Catalog Library.



Once you open the page you'll be able to view full .PDF versions of each catalog simply by clicking on the image of that catalog's cover. Browse through them page by page at your convenience. When you find a product that you want more information for, or would like to order just click on its Catalog Number and you'll go directly to that product's Offer Page. It's another convenient way for you to shop at crlaurence.com.

See page IV for information about free CRL Catalogs on CD-ROM.

C.R. Laurence Catalog Policy

NORTH AMERICAN BUSINESSES

Businesses who wish to open a new account with CRL can use a valid major bankcard to purchase any CRL Master Catalog for \$40.00, plus the cost of shipping. Once the new account accumulates \$1,000.00 in purchases we will issue a \$50.00 credit to that account towards the purchase of CRL products. No cash or bankcard credits will be issued. New accounts must use a valid major bankcard to purchase a CRL Catalog, as no C.O.D. orders will be allowed.

Current accounts in good standing who have done at least \$500.00 in business with CRL in the past fiscal year will receive a CRL Master Catalog relating to their type of business free of charge whenever it is published. When their annual purchases surpass \$2,000.00 these same accounts can request any CRL Master Catalog to be shipped free of charge with their next order.

C.R. Laurence Company is a Business-To-Business manufacturer and distributor, and we have a Catalog Policy that we believe is fair to all businesses.

OVERSEAS BUSINESSES

Overseas businesses can open a new account with CRL by using a valid major bankcard payable in U.S. funds to purchase any CRL Master Catalog for \$40.00, plus the cost of postage. Once the new account accumulates \$1,000.00 in purchases we will issue a \$50.00 credit to that account towards the purchase of CRL products. No cash or bankcard credits will be issued. New accounts must use a valid major bankcard payable in U.S. funds to purchase a CRL Catalog, as no C.O.D. orders will be allowed.

Current overseas accounts in good standing who have done at least \$500.00 in business with CRL in the past fiscal year can request a CRL Master Catalog relating to their type of business to be included free of charge with their next order. When their annual purchases surpass \$2,000.00 these same accounts can request any CRL Master Catalog to be included free of charge with their next order.



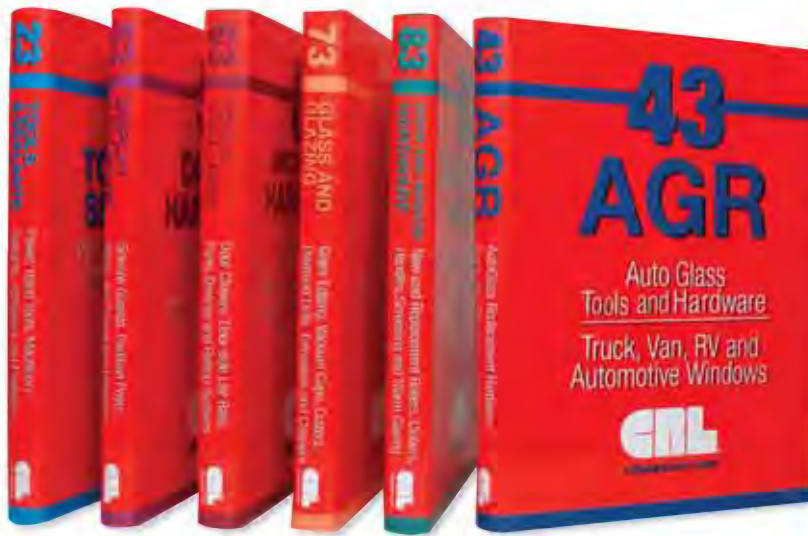

CRL
MASTER
CATALOGS

**43 AGR is the
First in the
New Series of
Six Master
Catalogs**

THE MOST COMPREHENSIVE SOURCE OF PRODUCTS AND SERVICES FOR GLAZING, ARCHITECTURAL, CONSTRUCTION, INDUSTRIAL, AND AUTOMOTIVE BUSINESSES

Back in the “good old days” when everything we offered could be presented under one cover we introduced our CRL93 “Big Red” Master Catalog. At nearly 1,000 pages it was a complete guide to all CRL products and services. But as time progressed, and we added more products, it became apparent to us that one big book just couldn’t contain them all. So we introduced a series of smaller New Products Catalogs to be used alongside “Big Red”. This seemed like a good solution until the most recent New Products Catalog grew to over 400 pages. Something had to give.

It occurred to us that if we were to continue the practice of offering Master Catalogs they would have to be re-designed into an easier-to-use format. So plans were made to re-issue our Master Catalogs in a series that would encompass our entire product line, but would do so in a more organized manner, tailored to the needs of our customers and the various industries they represent.

The 43 AGR is the first in this new series of Master Catalogs. It focuses on the Auto Glass Replacement portion of the glass industry, and is an inclusive volume of tools, parts, fasteners, and adhesives manufactured by leaders in these fields. At over 400 pages it is typical of the six-volume Master Catalog set that is now in production at our Los Angeles Corporate Headquarters.

Each of the six catalogs will focus on one specific portion of the glass business, and will be a compilation of the tools and supplies relating to each:

- **23 TOOLS, SEALANTS, ADHESIVES, AND FASTENERS**
- **43 AUTO GLASS TOOLS, HARDWARE, AND WINDOWS**
- **53 DISPLAY AND TRANSACTION HARDWARE**
- **63 ARCHITECTURAL HARDWARE**
- **73 GLASS AND GLAZING TOOLS AND EQUIPMENT**
- **83 DOOR AND WINDOW HARDWARE**

Please be assured that we will also continue to produce our Specialty Catalogs on a regular basis for the industries they represent. These include our Shower Door, Architectural Hardware, Architectural Railing, Door Control, Transaction and Security, and Automotive Accents Catalogs that so many of our customers find useful as presentation pieces to show their customers. You will also be able to get our catalogs on CD-ROM, as well as download or view them online at crlaurence.com. As we said on the previous page, C.R. Laurence is a catalog company. It’s something we feel we do well, and will continue to do in order to serve you better.

We Invite You to Be Part of the Process

No one knows better what he or she would like to see in a catalog than the people who use it. We make an effort to make our catalogs as thorough as possible, but it never fails that as soon as we introduce a catalog one or more of our customers will come up with a comment or a suggestion that makes us say “Why didn’t we think of that?” We’ve received lots of useful suggestions on how our catalogs could be better, and are always pleased when someone takes the time to tell us their ideas on what they would have liked us to include.

Do you have a suggestion you would like to share? We would be more than appreciative to hear from you. Please send your catalog comments or suggestions by e-mail to Webcomments@crlaurence.com. No idea is too small to share with us. Great rivers begin with just one drop.

CRL CATALOGS AND LITERATURE

CRL Specialty Catalogs

- Full Color Catalogs Showcasing Specific Product Lines
- Great for Customer Presentations

CRL Specialty Catalogs are available for some of our major product lines. Each catalog is presented in full color, and contains descriptive and informative specifications that will assist your field sales and estimating staff in the selection of the right product to satisfy your customer's needs. We invite you to contact CRL Customer Service by phone, fax, mail or e-mail. You can order them separately, or add them to your regular product orders. You can also view them over the Internet, or download them to your computer, when you log onto our web site at crlaurence.com.



CRL is your source for the largest selection of Frameless Shower Door Hardware and Supplies. See it all, with photographs of finished installations, in this informative catalog.

ASK FOR CATALOG SD05



CRL offers the largest selection of Architectural Railing Systems. See them all, plus beautiful photographs of finished installations, in our Railing Systems Catalog.

ASK FOR CATALOG HR05



Our Architectural Hardware Catalog features our expanded selection of architectural metal and glass hardware for the construction of "all glass" entrances in commercial office buildings and storefronts. There are photos of finished projects, as well as helpful technical data to help you create your designs.

ASK FOR CATALOG AH03



Our line of Door Closers and related Door Control Hardware can be found in this full color catalog. Specifications and ordering information make it easy for you to select the right product every time.

ASK FOR CATALOG DC04

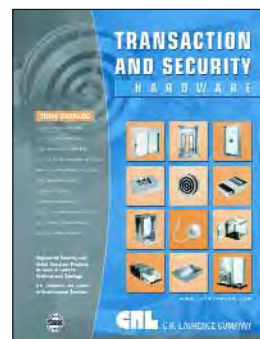

See the latest in top quality Transaction Hardware and bullet resistant exchange products, beautifully illustrated with specifications and installation photographs.

ASK FOR CATALOG TH04



Our Truck and Van Accents Catalog details the CRL automotive product line of quality truck sliders, sunroofs, van windows, and other automotive accessories.

ASK FOR CATALOG TV03

CRL Catalogs on CD-ROM

- Over 1,000 Pages at Your Fingertips
- Ask for One FREE with Your Next Order

C.R. Laurence Catalogs are also available on CD-ROM in full color PDF (Adobe Acrobat) format. Our CD-ROM puts at your fingertips well over 1,000 printed pages of information from our most recent Specialty and New Products Catalogs. Best of all, it's available FREE to all businesses when you establish an account with CRL. Just ask us to include one with your next order, or request one online at crlaurence.com.



CRL Products are Also Featured in the Sweet's Catalog



Contact us for free copies of buyline inserts from the various sections in which we appear.



LOG ON TO crlaurence.com FOR BUSINESS-TO-BUSINESS SERVICES

IV | PHONE (800) 421-6144 | FAX (800) 262-3299 TOLL FREE FROM ANYWHERE IN THE U.S.A. OR CANADA

CRL93 and CRL33 Catalogs

- The Original “Big Red” Catalog Set with Over 1,400 Pages of Products
- The Most Thorough Selection of Products in the Industry

While we’re completing our new six-volume Master Catalog Series we urge you to hold onto your CRL93 and CRL33 “Big Red” Catalogs. Use them as your combined guide to all CRL products and services. With over 1,400 total pages between the two catalogs you’re more than likely to find just what you need to do the job.



CRL93
Almost 1,000 pages of products!

CRL33
Over 400 full color pages of products!

Spec Data and MSDS



Spec Data (Specification Data Sheets) and MSDS (Material Safety Data Sheets) for eligible products are available through crlaurence.com. Just go to the product's Offer Page and click on the Spec Data or MSDS icon located at the top of the page to review the document, or print a copy for your records.



Press Releases and Technical Articles

When you visit crlaurence.com make sure you check our News and Events area on the home page. It's here where we publish the Press Releases we send to the various industry magazines. You'll also find a number of Technical Articles written by CRL Product Specialists. These Tech Articles have lots of useful information on how to do a better, more efficient job, and how to get the maximum out of the tools and supplies you buy from CRL.



Product-of-the-Month Sale

- Save 10, 15, 20, 25% or More, Plus Get Freight Incentives and Free Bonuses with Qualifying Orders

CRL customers who receive our Product-of-the-Month Sale Flyer get extra special savings on our newest and most popular products. Twelve times a year we offer some of the products you use most at discounts of up to 25%, plus throw in freight incentives and free bonus items for qualifying orders. You get a whole month to take advantage of these special savings and offers, and all you need to do to get them is place your qualifying order. The CRL Computer System automatically gives you the sale prices, whether you place your order by toll free phone, toll free fax or over the Internet. You can also get details of our Product-of-the-Month Sale when you log onto crlaurence.com.



Welcome to the World of crlaurence.com

C.R. LAURENCE COMPANY INC.
AN ISO9000 COMPANY
Supplying the World with Glazing, Industrial, Construction, Architectural and Automotive Supplies

Product Search Here [Go] [Help]

Log In Home Contact Us Bulletin Board Documents Product of the Month View Cart and Checkout
Auto Glass and Accessories Glass Hardware and Accessories Sealants, Tools and Accessories New Product Section

Non-Customer Menu
• New Account Request

Searching on CRL
• A to Z Product Index
• New Product Area
• Popular Product Lines
• Product Document Search
• Products by Catalog
• Products by Industry
• Truck Slider Search

Products & Services
• Aluminum Railing Systems
• Architectural Customers
• Automotive Products
• Display Systems
• GlassWedge® Handrail Systems
• Hand Held and Power Tools
• Machinery and Large Equipment
• Product Finishes
• Shower Doors
• Transaction Hardware

General Information
News & Events
Help Tutorials

PRODUCT OF THE MONTH
GET BIG SAVINGS
ON ALL CRL ABRASIVE BELTS AND DISCS DURING NOVEMBER 2004

INTERNET BONUS OFFERS
CLICK HERE to view what you can get this month

NEW 400+ Page Master Automotive Catalog Here This Month

New Feature for Logged In Customers
Check On, Change or Inquire on Any of Your Open Orders
First Log In, click on "View Your Open Orders", then click on the order you want to work on. Now click on "Change or Inquire on This Order". On the next screen select what you would like to do, and click Submit.

Recently Added Product
CRL "Perfect Fit" POWR-Slider for 2004+ Chevy Colorado/GMC Canyon
Fully Contoured "Perfect Fit" Frame with Flexible Flange
Solar Privacy Glass Opens or Closes Quietly
Narrow Stiles and Tight-Sealing Weatherstrip

CRL CATALOG LIBRARY
GlassWedge Systems
BULLETIN BOARD
Auto Accessory Close-Out Sale
Discounted Shower Hardware
SHOWERSonline Subscribers LOG-IN
ALL GLASS Storefronts Subscribers LOG-IN
NEW Lower Prices Every day on Mirror Channels

What Can You Find At crlaurence.com?

- Our Business-To-Business Approach of Bringing You the Most Thorough Source of Information on All CRL Products and Services
- Access to All CRL Products Through Our Easy-to-Use A to Z Product Index
- Ordering and Shipping Information
- Internet Only Ordering Bonuses
- Open Order Status and Add-On Option
- New CRL Products and Services
- The Latest CRL e-News Newsletter
- Technical Articles and Product Support
- Photo Galleries of Finished Projects
- Account Policies and Credit Terms
- Direct e-Mail Connections to CRL Departments
- And Much, Much More!

What you will find at crlaurence.com is a link to who we are, what we do, and what we have to offer our customers. The CRL Web Site allows us to use the powers of Electronic Commerce to bring you closer to all of the products and services that have made us the glass industry's supplier of choice for so many years.

We take a Business-To-Business approach of doing business over the Internet because it gives us so many ways to connect with you. There are methods of searching for and ordering products that just a few years ago would have been impossible were it not for the versatility of this powerful tool.

And empowerment is what a good web site is all about. We let you make the decisions that will best serve you. You can build your orders and submit them 24 hours a day, seven days a week, at your convenience, not ours. You can make additions and changes to unshipped orders, or track shipped orders from door-to-door. You can monitor your account, and get an up-to-the-minute status of your outstanding balance. And you can review the over 25,000 products we make available, including pricing and current stock availability.

All of this is available to CRL customers who have logged on to our web site and become part of the world of crlaurence.com. Over the next few pages we will detail many of the features you can access, and describe how they can make it more convenient for you to shop at CRL. Should you have any questions, you can always send us an e-mail by clicking on the Contact Us button near the top and bottom of every page.



Registration/Log In

To get started at crlaurence.com we ask you to register the first time. If you already have a CRL Account Number you can use it to create a User Name and Password. You need to register a minimum of one time per account in order to take advantage of all online CRL benefits.

If you already have a User Name and Password just enter them, then click GO. You will remain logged in until you click the Log Off button, or if you clear/delete the cookies on your personal computer. If you're not sure if you have already set up a User Name, there's a place to check.

NOTE: Make sure you are logged in at all times, otherwise some Menu Bar options will not be available.



Navigation Bar

The Home Page is topped by a Navigation Bar that has buttons you can click on to link directly to the most popular areas of crlaurence.com. With one click you can: Get phone and fax numbers for CRL Departments; Directions to all CRL locations; Access our Customer Support Center or our Document Library; Review our Product-of-the-Month Sale; View and check out your Online Orders; Navigate Product Groups by catalog type. All of this is just a click away.

The Navigation Bar is also where you'll find our all-important 'Product Search Here' Box. This powerful option lets you locate CRL Products by entering their Catalog Number, or just a portion of the number. You can also use it to find products by entering key words or the names of products.

Navigating a web site with over 25,000 products doesn't need to be difficult. The 'Product Search Here' Box is the surest way to find exactly what you are looking for. For more information about finding products at crlaurence.com, turn to pages A501 to A503 in the rear of this catalog.

Customer Menu Bar

The Customer Menu Bar is a good starting point for navigating around crlaurence.com. It provides a direct link to virtually all areas that can be accessed after you log in, or after you have reviewed and selected products and now wish to order them.

At the top of Customer Menu is your link to Express Ordering, an easy to learn and quick to complete method of placing orders online whenever it's convenient for you. You set the schedule and the pace because you are in control. You can also build your 'Personal' Catalog by matching your part numbers to our Catalog Numbers. Requesting a quote is simple when you click to our Web Quote Requests module.

Next in the menu is Searching on CRL. We've gone into a lot of detail on this subject, and ask you to turn to pages A502 to A503 to review the different search methods we offer.

Products and Services has direct links to our "Information Centers" for many of our major product lines. They act like 'hubs' where you can reference the various categories of information pertaining to these product lines, including Product Offer Pages, Product Specs, Technical Drawings, Measurement Templates, Press Releases, Videos, and a variety of helpful information sources.

When you click into General Information you are presented with a selection that includes information about CRL's Business Policies, ways to contact us, our distribution locations, and package tracking. There's also a link to our Document Library of Comparison, Cross-Reference, and Specification Charts, Application Guides, New Product Submittal Forms, and more. When you click on the link called What's New you'll see a list of new pages recently added to the web site.

News and Events lets you review CRL e-News, Press Releases, Technical Articles, upcoming trade show dates and locations, and useful Internet links.

Help Tutorials are short video tutorials on how to do the most common tasks when using the CRL Web Site. They are sure to save you time by showing you the quickest and easiest ways to make the best use of crlaurence.com. For more information, see page IX.

Like we said above, the Customer Menu Bar offers you so many directions you can use to navigate around crlaurence.com. Take some time to explore all it has to offer.





crlaurence.com "Business - To - Business" Web Services

We designed crlaurence.com as a "Business-To-Business" web-based service to be better able to serve our customers, and for our customers to be better able to serve themselves, on their schedule, at their convenience. It is a constantly evolving form of Electronic Commerce that delivers information on new products, special offers, and other industry services that you can use to improve your business.

Our goal is to provide ever-improving service through all avenues of communication. We have an in-house Web Center whose mission is to add to and improve the features of this site, increasing its value to business users. We encourage you to contact us with your opinions, comments, and questions. We are always glad when visitors to crlaurence.com show an interest in making it better.

New Products Are Available Immediately

- New Products Can Be Viewed and Ordered as Soon as We Have Them
- No Need to Wait for the Next Printed Catalog or Sale Flyer, You Can See Them Now at crlaurence.com
- New Information on Existing Products is Updated as We Receive It



Whenever we add a new product it becomes available for viewing online immediately. No need to wait for the next printed catalog because crlaurence.com is updated daily with all product additions. The same is true if a product changes. We can update the Product Offer Page the same day we receive the information. That makes it easy for you to have the latest product information at all times.

Checking Prices Online

1. Log onto crlaurence.com
2. When the crlaurence.com Home Page appears enter the Product's **Catalog Number** in the 'Product Search Here' Box and Click **Go**.
3. The Product will be displayed with its **Catalog Number, Unit of Measure, and Current Pricing for Each Quantity Price Break**. If you can combine the Product with other Products for quantity pricing a message will appear directly below the prices. From here you can go directly into the ordering process, or return to the 'Product Search Here' Box at the top of the page and enter another Catalog Number.

NOTE: If a Product is currently part of a promotion the Sale Prices will be displayed in place of the regular prices, and an expiration date for the promotion will appear.



Automatic Updates of Account Information

• Accurate Records Improve Communications

One of the ways we use crlaurence.com to improve communications is through automatic updates of your business information, such as your shipping address, phone and fax numbers, e-mail addresses and the like. A few times each year we will ask you to check your account records when you log in. If something has changed you can make the changes right on the screen. There's no calling or mailing of forms involved.





crlaurence.com "Business - To - Business" Web Services

Contact Us Online

With this convenient feature of crlaurence.com it's easy for you to contact us online 24 hours a day. With just a click or two you can send e-mail to a number of CRL departments.

You can also get addresses, phone and fax numbers, even driving directions for all CRL locations in the United States, Canada, and Europe.

C.R. Laurence Co. Inc.
2503 E. Vernon Ave.
Los Angeles, California 90058-1897

Toll Free Phone: (800) 421-6144
Toll Free Fax: (800) 262-3299
International Phone: (323) 588-1261
International Fax: (323) 581-6522

Map of CRL Locations
CRL USA
CRL CANADA

You can contact any of the following departments directly by clicking on the Department's name:

DEPARTMENT	FAX
B2B Customer Services	(323) 584-5274
Discuss any Web Site Issue	
Credit	(800) 845-4529
Contact the Credit Department About Your Bill or Invoice	
Customer Service	(800) 262-3299
Contact Customer Service About any Order or Customer Service Issue	

Language Options

The primary language of crlaurence.com is English, but when you click on the flag icons at the top of the Customer Menu Bar you can also choose from computer-generated French, German, or Spanish.



Video Help Tutorials

This option on the Customer Menu Bar has short video tutorials on how to do the most common tasks when using the CRL Web Site. They teach you the quickest and easiest ways to make the best use of crlaurence.com.



Online Software

Subscribers to our Showers Online and Storefronts Online Optimization Programs access them through crlaurence.com. These web-based glass-sizing programs save subscribers countless man-hours, helping reduce labor costs.



CRL e-News

Subscribers to this free service get once a month updates on new products, our monthly promotion, industry events, technical bulletins, and more. Go to the crlaurence.com Home Page, click on the e-News banner and sign up now.



Bulletin Board

The CRL Bulletin Board is a place where you can get big discounts on overstocked and close-out items, post notices of things you have to sell, find a list of items you can buy from other CRL customers, place 'Help Wanted' notices, locate a new job for yourself, see a schedule of upcoming events and more. There's never any charge for posting notices. Check it out at crlaurence.com.

Suggestions for Improvement – What Would You Like Us to Offer?

One of the nice things about having a web site is that it is virtually limitless in possibilities. We are constantly working to improve crlaurence.com, and have received many positive and encouraging comments from our customers. We would appreciate your suggestions about what more we could offer you to increase the usefulness of our web site. To submit comments, go to crlaurence.com and click on Contact Us, then click on Webcomments. We thank you in advance.



Product Offer Pages - What They Offer You

The screenshot shows a product page with the following annotated features:

- 13**: Navigation menu (Home, Contact Us, Customer Support, Documents, Product of the Month, View Cart and Checkout)
- 1**: Product title: CRL POWR 300 Series Primerless-to-Glass High Viscosity Urethane
- 2**: Product features: Primerless-to-Glass Formula, Excellent High Strength and Rapid Curing, Passes or Exceeds F.M.V.S.S. 208/212/216
- 3**: Product image: A tube of urethane adhesive
- 4**: Product description: CRL 300 Series Primerless-to-Glass High Viscosity Urethane is a high quality adhesive that passes or exceeds the requirements of U.S. Federal Motor Vehicle Safety Standards 208, 212, 216 and OEM specifications. With over 1,000 psi of tensile strength and 600 psi lap shear at ultimate cure, PP301HV is one of the safest and strongest urethanes offered for the aftermarket. These urethanes have a new Aggressive Adhesion Formula and have proven themselves to aggressively bond to all automotive glass surfaces and frits without needing a glass primer. Long term exposure testing confirms that the new formula stands up to the harshest environmental conditions.
- 7**: Additional Product Details Below. Click Here.
- 6**: Product table with columns: Catalog Number, Description
- 5**: Product specifications: Catalog Number: PP301HV, Also Available in These Catalogs: CRL33 New Products Summer 02, PAGE E365, Tensile Strength: 1,000 psi, Lap Shear Strength: 600 psi, Ship Via: Can Ship UPS, Shipping Weight: 1 lb (454g), Case Qty: 24, Minimum Order: 1 Each
- 8**: Product Group navigation: Press Product Group
- 9**: Stock availability: Check Stock Availability
- 10**: Pricing: Pricing for Calling # PP301HV, Unit of Measure = Each
- 11**: Quantity selector: Quantity, U.S. Dollars
- 12**: Add to cart: Add
- 14**: Add to My Personal Catalog

The ultimate destination when searching crlaurence.com for any product is the Product Offer Page, which contains:

- (1) A Descriptive Product Title for the purpose of making a quick selection from any of our search options.
- (2) A Summary to highlight important Product features.
- (3) An Image of the Product, sometimes accompanied by additional diagrams or color selections.
- (4) A Description of the Product's features, advantages, and benefits, with details to assist your selection.
- (5) The Catalog Number and other Specifications relating to the Product's application, dimensions, colors, etc.
- (6) Many Products are available in multiple sizes, colors, or types. If so, Catalog Numbers and Descriptions are also shown for these.
- (7) Additional Product Information and other important notes about the product are displayed at the bottom of the page. These sometimes include specifications, advisories or cautions relating to the handling and storage of the Product.
- (8) From Product Group is a navigational tool that lets you access other Products in similar product categories. It improves your search capabilities for related Products.

- (9) A place to check the available stock of the Product in your nearest CRL warehouse, and other CRL warehouses nationwide.
- (10) Pricing per Unit of Measure for the Product. In many cases you can reduce your cost by ordering in multiples, so we show you the price at each Quantity Price Break. All prices are shown in U.S. Dollars, except for our Canadian accounts, whose prices are shown in Canadian Dollars.
- (11) A place to specify the Quantity of the Product you want to order, and a one-push operation to include it on the order you are building.
- (12) Advisories on whether the Product can be combined with other Products for Quantity Pricing and/or a Freight Allowance.
- (13) Many Products have available documents, such as Spec Data and Material Safety Data Sheets. If so, access to these is provided by clicking on the appropriate icon.
- (14) With one click you can add the Product to your Personal Catalog.

The Product Offer Page should provide you with all of the information you need to make an informed decision about which product or products will best serve your needs. Additional information about all products can also be obtained from our Master and Specialty Catalogs. See pages II to V for details on CRL Catalogs.

Now that you've seen all that crlaurence.com has to offer, plus how easy it is to use, we invite you to visit as often as you wish, and encourage you to use it for your next order. Why not try it today?





C.R. Laurence "Business - To - Business" Customer Services

CRL Serves the World With Ever-Improving Service Capabilities

C.R. Laurence has served customers worldwide for decades, offering a full range of products and services unmatched by any other supplier in the glass industry. In this time we've prospered as a company because we've followed a path of innovation and growth, always seeking new ways to expand our service capabilities.

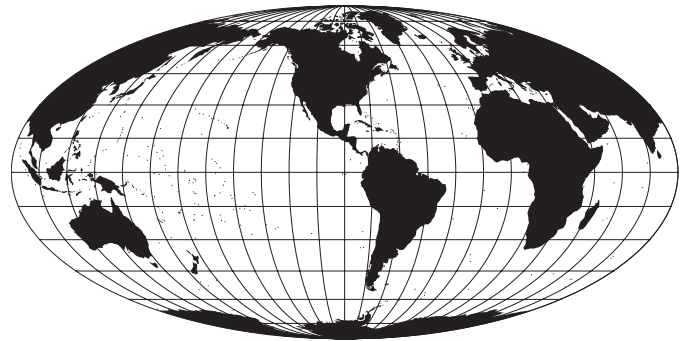

Communicating

Major advancements in the world of communications have made much of this possible. We've always been among the first to introduce new ways of reaching our customers, and in return, have made it easier for them to do business with us.

C.R. Laurence was the first in our industry to offer toll free telephone ordering. For over thirty years our customers have been able to call our 1-800 number to place orders, ask questions about products, get prices, and communicate with us without it costing them a cent.

In the early '80's we added toll free fax ordering, making it possible for our customers to fax their purchase orders, parts lists, shop drawings and the like directly to our Customer Service Department at CRL Corporate Headquarters. It was during this time that we also introduced CRL FastFax, providing customers instant notification that their orders had been shipped.

One of our most important advances was the installation of the CRL Computer System in 1978. The power of our abilities multiplied many times when we went 'online' because we were better able to track inventory levels throughout our distribution network, and better able to process your orders quickly and more accurately. The ongoing evolution of the CRL Computer System now includes our Internet and fax servers, which empowers us to offer our customers ever-improving service at every step in the process, from order entry through shipping and billing.

Some say our most important communications advancement was our entry into the business of Electronic Commerce with the introduction of the CRL Web Site in 1997. What was once a fledgling effort has blossomed into a complete "world" of information regarding all of the products and services CRL has to offer. Customers who use crlaurence.com find an enlightening and comprehensive web site that is constantly improving with the addition of new features that make it quicker and easier to use. For more complete information about crlaurence.com, see pages VI to X.

C.R. Laurence makes a serious effort to promote ever-improving service by making the investments required to improve communications at every level. We want your business dealings with CRL to be simple, clear, and convenient. If you feel that we can improve communications at any level, we would like to hear from you. Please e-mail us at Webcomments@crlaurence.com.

Building A Network

To provide the ever-improving service level we strive for has meant bringing CRL to our customers. From a single Los Angeles, California location we have grown to a network of distribution warehouses across North America that puts us within two days ground shipping service to over 90 percent of our customers.

Each of our distribution warehouses are connected to Corporate Headquarters through our Computer System, which monitors and updates inventory levels with the arrival of each new delivery truck and the shipment of each customer order. Every warehouse receives fresh inventory each week through our Inter-Branch Transfer System so stock levels can remain high. This improves the percentage of your orders we can ship complete, and usually on the same day we receive them.

Another advantage of having regionally located warehouses in or near major metropolitan areas is the opportunity to serve our customers in person. Each CRL location has a Will Call Department open six days a week. See page XII for more information about CRL Will Call Service. For directions to CRL locations, go to the crlaurence.com home page, point to General Information, and then click on About CRL. The pop-up menu will give you a selection for Distribution Locations.

And in order to provide ever-improving service the CRL network of distribution warehouses will continue to grow. New locations are planned for metropolitan areas throughout the U.S. With the opening of each new facility, we make getting what you want from CRL faster and easier.

Investing In People To Serve You

The best way we can serve you is to have capable people available to answer your questions, take and expedite your orders, suggest solutions to problems you may be having with a job, or to assist you in any manner we can. We maintain ongoing training programs so that the CRL people who serve you will have at their command the resources to make your business transactions with us a pleasant experience.



CRL CUSTOMER SERVICES



C.R. Laurence "Business - To - Business" Customer Services

We are always pleased to receive your orders, and anxious to fill them as promptly as possible. You can place your order at CRL in a number of ways. Our people will do their best to make your shopping experience at CRL pleasant and time-efficient.

Methods of Ordering



Online at crlaurence.com

Many of our customers have found the most convenient method of ordering from CRL is through our web site. When you use crlaurence.com to place your orders you have so many options that other methods don't provide. You set the schedule and the pace because you can log on 24 hours a day, seven days a week. You can build a personal catalog; even make changes or additions to your orders online. There's no easier way! See pages VI through X for more information about the benefits of ordering at crlaurence.com.



Toll Free Fax Service

When we introduced toll free fax service in the '80's we had no idea how popular it would become, but now our customers send us up to 1,000 orders or quote requests every business day! Fax ordering is very convenient because you can fill out your own purchase orders and then just fax them to us. You can be specific about shipping instructions or other details that will help us serve you. To send your orders or quote requests by toll free fax from anywhere in the U.S. or Canada, just dial (800) 262-3299.



Toll Free Customer Service Order Desk

For over 30 years CRL has provided toll free ordering at (800) 421-6144. When you call our Customer Service Order Desk you'll find CRL people who are trained to provide assistance with CRL products and services. They have instant access to pricing, stock availability, and the status of your account, plus they can connect you to CRL Technical Sales personnel if you need specialized product assistance. Order Desk hours are 6 am to 5 pm (Pacific Time) Monday through Friday, and 7 am to 12 pm Saturdays.



Direct Sales and Service (DSS) Reps

You can also call toll free to speak with the Direct Sales and Service (DSS) Representative who services your account. Your DSS Rep knows your account, and has immediate access to information on your current orders, past shipments, and pending quote requests. They can help you with upcoming orders, and will always make sure you're informed about current promotions. For the personal touch, stay in contact with your DSS Representative by calling toll free (800) 421-6144.



Will Call Order Desk

Every CRL distribution warehouse has a Will Call Order Desk where you can place and pick up your orders in person. And when you place your order in advance by phone, fax, or over the Internet we can have it ready and waiting for you, which can save you a lot of time. Will Call hours are 8 am to 5 pm Monday through Friday, and 8 am to 12 pm Saturdays. Some of our most experienced people staff our Will Call Departments, and they are always happy to see you.

Who May Buy

C.R. Laurence is a manufacturer and wholesale distributor. Possession of this catalog, or any other CRL sales literature, does not constitute an offer to sell. Orders from individuals (except professional tradesmen) may not be accepted.



LOG ON TO crlaurence.com FOR BUSINESS-TO-BUSINESS SERVICES

XII | PHONE (800) 421-6144 | FAX (800) 262-3299 TOLL FREE FROM ANYWHERE IN THE U.S.A. OR CANADA



C.R. Laurence "Business - To - Business" Customer Services

Other CRL Services

Technical Sales Department

The CRL Technical Sales Department has expanded into Product Specialist Groups who can assist you with design plans and installation questions pertaining to your field of business. Product Specialist Groups include: Architectural Business Development; Commercial Hardware; Aluminum and Glass Railings; Frameless Showers; Transaction Security; Glass and Glazing; Auto Glass.

Your job can be made easier with the help of CRL Specialists who are trained in the newest hardware systems, and can offer detailed diagrams, layout sheets, product data specification data or custom ordering menus by fax or mail. We can "walk" you through a difficult installation, or help analyze the cause of a problem. From the beginning stages of design through final installation, we are here to help you.

Our Technical Sales Department can be reached by:

- Phone Toll Free (800) 421-6144 from anywhere in the U.S.
- Phone Toll Free (877) 421-6144 from anywhere in Canada
- Phone (323) 588-1281 (International)
- Toll Free Fax (800) 587-7501
- For e-mail, go to crlaurence.com, click on Contact Us, then click on Technical Sales.

CRL offers our customers a variety of services, and all are backed by CRL's full commitment to serve the needs of your business. It is our goal to make every transaction with CRL a benefit to you because we appreciate your continued business.



Worldwide Shipping Services

Whether your next big project is around the block or around the world, CRL can ship your order most anywhere you need it. Our Import/Export Department moves hundreds of shipments to and from overseas locations every year, so we know what it takes to get it there on time and all in one piece. If you have an order that you need shipped directly to a job site, regardless of the continent, we can provide full assistance. For complete information on shipping, go to crlaurence.com and click on CRL Business Policies.

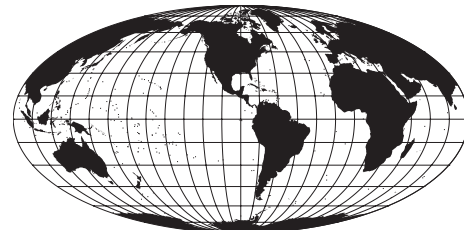

CRL Works With You

We offer more than just the products shown in our catalogs. CRL is your source for goods and service from hundreds of manufacturers worldwide. The experience gained by decades of service affords us the ability to serve you in more ways than you might realize. Such services also include:

- Price Quotes on Large Quantity Buys, Bulk Packaging, and Private Label Products
- Special Orders of Non-Catalog Merchandise
- Special Quick Fabrication Programs
- Direct Shipments and Just-In-Time Delivery
- Technical Drawings and Product Specifications

For more information on these and other ordering services that CRL can provide, go to the crlaurence.com home page and click on General Information, then select CRL Business Policies from the pop-up menu and click on it. Now point to Custom Order Services and click on it for full details on all the ways that CRL can work with you.

CRL Business Policies

We publish our Business Policies on our web site. To review them go to the crlaurence.com home page and click on General Information, then select CRL Business Policies from the pop-up menu and click on it.

At this point you will have a choice of policy categories from which to choose. Click on any one of them to find definitions of our business policies. If you need further clarification on any of our policies go to crlaurence.com and click on Contact Us, then click on Webcomments.

Checking Prices

For current pricing go to crlaurence.com and log on using your User Name and Password. You can then see the prices for any product on its Offer Page. For more information on how to check prices, see Checking Prices Online on page VIII. **NOTE:** All prices are subject to change or withdrawal without notice.





CRL Manufacturing

- **Maker of Premium Automotive Windows for the Aftermarket and Original Equipment Manufacturers**
- **User of Progressive QS-9000 Manufacturing Processes**
- **Mechanical and Technical Expertise Available to Assist Your Manufacturing Processes**

You may know C.R. Laurence Company as North America's largest distributor of supplies to the glass industry however; you may not know that we are also a manufacturer of over 3,000 products found in our online catalog. Our 270,000 plus square foot manufacturing plant in Vernon, California is just five minutes from CRL Corporate Headquarters, and ten minutes from downtown Los Angeles. Here we employ over 350 people to make some of the best products available to customers worldwide. Our people use progressive QS-9000 manufacturing processes to make products for the Glazing, Architectural, Construction, and Automotive industries. These certified processes ensure that we give every product our full attention to detail.

There are many industries served by the products manufactured in our California plant. Automotive windows represent only a portion of them. We make architectural hardware for new and retrofit building construction, railing systems and windscreens for balconies and decks, security transaction windows and devices, display hardware for the retail trade, and specialty tools for the glazing trade. We also manufacture a fine selection of hinges and other products for frameless shower doors in our Concord, Ontario headquarters of CRL Canada. Using strict manufacturing standards we continue to produce the kind of quality hardware that has kept us at the head of this field for many years. That's your assurance that when you select a product made by CRL Manufacturing you have made the best possible choice.

We're always looking for ways to make our products better, and along the way we've added knowledgeable experts in their fields to our staff of designers, engineers, and craftspeople. Our goal is to make our products a better value to you, whether it's time or labor savings, extended service life, increased versatility or enhanced visual appeal.

Many of our products incorporate industry "firsts", features offered by no other manufacturer because we feel that no product or process is so good that it can't be improved. We strive to make products of high quality and value. That's the goal we set for ourselves at the onset, and it's still our guiding influence.

Some of the improvements we've made have originated from people who have used our products and generously contributed their opinions and suggestions. We welcome your comments, and invite you to contact us at any time regarding a C.R. Laurence product.



CRL Manufacturing Will Put Their Expertise and Resources to Work for You

- Our Strengths Can Become Your Strengths
- We Can Do the Work for You and Then Make Shipments Anywhere in the World
- Fair and Accurate Quotes Provided for One Time Custom Work or on a Per Unit Production Basis

Quality

C.R. Laurence Manufacturing has almost 40 years experience in producing products for the industries we serve. During that time we've learned a lot about what it takes to make quality products, and do so in a cost-efficient manner. We've also learned what it takes to please customers who have very high standards, and as a result have earned a number of very prestigious awards for manufacturing excellence.

Meeting Your Manufacturing Needs

We can meet the manufacturing needs of businesses big and small. C.R. Laurence Manufacturing offers a variety of services to help you produce high quality products you will be proud to put your name on. We use progressive QS-9000 manufacturing processes to make quality tools, parts, and accessories for some of the world's largest corporations. We also serve the needs of smaller, more specialized businesses. CRL will help you make products you can provide to your customers with complete confidence.

What We Can Offer

Our capabilities encompass most every phase of the manufacturing process, from the early stages of design, all the way through to packaging and shipment. We can supply services such as:

Engineering * Cutting * Drilling * Machining * Welding * Cladding
Painting * Polishing * Assembly * Packaging * Shipping

Interested? Contact Us

We welcome the opportunity to serve you, and are committed to providing your business with the services that produce quality products. To discuss the possibility of working with CRL Manufacturing we invite you to contact CRL Technical Sales at (800) 421-6144 in the U.S., (877) 421-6144 from Canada, or (323) 588-1281 International. Ask for Ext. 7700. For e-mail, go to crlaurence.com, click on Contact Us, and then click on Technical Sales.



Our Engineering Department reviews job plans to address feasibility, safety concerns, and possible alternate solutions in order to prepare a fair and accurate per unit or per job quote for our services



By machining parts in batches we can reduce turnaround times and costs per unit



Precise sheet metal bending results in finished parts with exact tolerances



Cutting services are available for production runs or custom order jobs



Our computerized CNC Machines make custom drilling and machining services possible



The Sheet Metal Department's CNC Brake Press and Shear does custom metal cladding



Our Paint Lines can apply architectural and industrial powder coated finishes to parts up to 25 feet in length



Our Finishing Department provides expert hand polishing for metal parts



Parts can be processed through our Ultrasonic Cleaning System after finishing



We also offer hand assembly and packaging of delicate or easily damaged materials



Finished materials can be packed, crated, and then shipped anywhere in the world

C.R. Laurence Canada



C.R. Laurence Canada Corporate Headquarters, Concord, Ontario.
Other Locations in Montreal, Vancouver, and Calgary Areas

C.R. Laurence Canada operates from four major metropolitan locations across Canada to bring our customers fast and efficient service coast-to-coast. We are an ISO-9001:2000 certified company that follows internationally recognized standards for service excellence.

All CRL Canada locations utilize modern materials handling technology, and inventories are refreshed weekly in all warehouses. We do everything possible to assure that your orders can be shipped quickly and correctly.

Whenever you use our toll free telephone (800) 421-6144 and fax (800) 262-3299 numbers you are connected to the CRL Canada location that serves you, and not a centralized call center thousands of miles away. The people you talk to are also the people who process and ship your orders. Each location also offers Will Call service Monday through Saturday.

French speaking customers can use our multilingual Internet site to enjoy complete access to all CRL services. You can search in English, or computer generated French, Spanish, and German. We also print our Product-of-the-Month promotions in both English and French so that everyone can take advantage of the special savings we offer monthly.

The most thorough resource of all CRL products and services is crlaurence.com. Here you will find all that CRL Canada has to offer, organized in a simple to use format. Take your time to browse through the site, or to build an order. You can do it all at your pace, 24 hours a day. No other supplier in the glass industry has anything like it. For more information on using crlaurence.com, see pages VI through X.

We welcome the opportunity to serve you, and hope you will make CRL Canada your supplier of choice.

Pricing in Canadian Dollars

All transactions between CRL Canada and our customers are conducted in Canadian Dollars. This includes all prices shown on the CRL Web Site, on quotes, on orders, and on invoices, whether the product originates from one of our facilities, or are imported from manufacturers in the United States or overseas. For current pricing, call us toll free at (800) 421-6144, or log on to the CRL Web Site at crlaurence.com.

Four Locations to Serve All of Canada from Coast-to-Coast

For contact information on all CRL Canada locations go to crlaurence.com and click on the Contact Us button in the Home Page Navigation Bar.

C.R. Laurence Canada opère à partir de quatre locations métropolitaines au Canada afin de donner à nos clients, un service rapide et efficient, d'une côte à l'autre. Nous sommes une entreprise certifiée ISO-9001:2000 qui suit les standards internationaux d'excellence en matière de service.

Toutes les locations CRL au Canada utilisent des technologies modernes et nos inventaires sont mis à jour toutes les semaines. Nous faisons notre possible pour que votre commande soit expédiée rapidement et correctement.

À chaque fois que vous utilisez notre numéro de téléphone gratuit (800) 421-6144 et notre numéro de fax (800) 262-3299, vous êtes connectés à l'entrepôt CRL qui vous sert, et non pas à un centre d'appel à des milliers de kilomètres de là. Les personnes à qui vous parlez, sont aussi les personnes qui traitent et expédient vos commandes. Chaque location offre aussi le service Will Call, ouvert du Lundi au Samedi.

Les clients parlant français peuvent utiliser notre site Internet multilingues pour avoir un accès complet aux services CRL. Il peut être consulté en Anglais, en Français automatiquement traduit par ordinateur, Espagnol et Allemand. Nous imprimons également nos promotions du Produit-du-Mois, en Anglais et en Français de manière à ce que tout le monde puisse tirer avantage des économies que nous offrons mensuellement.

De tous les produits et services CRL, la ressource de valeur reste crlaurence.com. Vous y trouverez tout ce que CRL Canada peut offrir, organisé en un format simple à utiliser. Prenez le temps de naviguer au travers du site ou pour placer une commande. Vous pouvez le faire à votre rythme, 24 heures par jour. Aucun autre fournisseur dans la vitrierie a un outil de ce type. Pour de plus amples renseignements sur comment utiliser le site crlaurence.com, lisez de la page VI à la page X.

Nous sommes heureux d'avoir l'opportunité de vous servir et espérons que vous ferez de CRL Canada votre fournisseur de choix.

CRL CANADA 

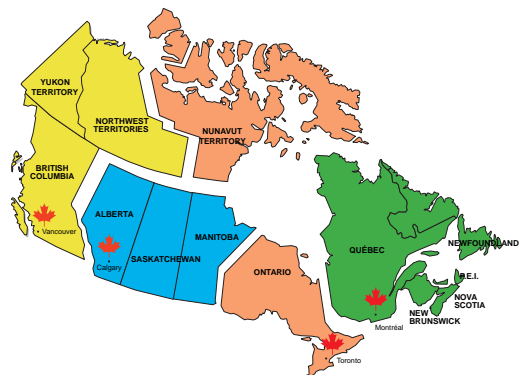

LOG ON TO crlaurence.com FOR BUSINESS-TO-BUSINESS SERVICES

XVI | PHONE (800) 421-6144 | FAX (800) 262-3299 TOLL FREE FROM ANYWHERE IN THE U.S.A. OR CANADA

CRL Urethane Systems

- Complete Adhesive Systems that Meet or Exceed U.S. Federal Motor Vehicle Safety Standards 208, 212, and 216
- Covered by \$20 Million of Product Liability Insurance



LYNX
SERVICES
Part of the LYNX Services
Quality Adhesive Program.
See Page A109

CRL 900 Series

- Superior Strength
- Cost Effective

Our CRL 900 Series High Viscosity and Fast Cure Urethanes provide the aftermarket an adhesive that not only provides superior strength over OEM specifications, but also puts you on the fast track to profitability. Compared with competitive products, CRL 900 Urethanes are the best choice you can make in this competitive market.

CRL 900 Series Urethanes are supported by a selection of Primers formulated for use in all aspects of glass bonding, including a glass frit primer, a pinchweld primer, and a primer specifically formulated for use with EPDM/PVC moldings. It is a complete system that, if used properly, will result in a superior bond.



POWR Primerless 300 Series

- Primerless Adhesive
- High or Medium Viscosity

The most recent addition to the CRL Urethane System is our 300 Series Primerless Urethanes. This advanced aggressive adhesion formula has proven itself to bond to all automotive glass surfaces and frits without glass primer. This new formula's aggressive behavior will provide safe, secure bonding without leaks or callbacks.

To protect the bond line of automotive glass for the life of the installation, CRL recommends that a UV blocking agent be applied to the glass surface. UV blockers absorb ultraviolet radiation, preventing it from breaking down the carbon black of the urethane and protecting the bond from degradation. POWR 300 Urethanes are supported with UV blocking agents, pinchweld primers, and bond enhancing agents to provide you with the proper links to a trouble free installation.

CRL 700 Series

- Heated Formula/Fastest Cure
- Rates Non-Conductive

CRL offers automotive urethane in a heated formula for faster safe drive away times. CRL 700 is also acceptable for non-conductive applications.

An additional feature of CRL 900 and CRL 700 Urethanes is our single primer system. No need to purchase and apply one primer to clean or condition the glass and another black primer for adhesion of the urethane to the frit. CRL9GC Glass Primer performs both functions. Combine this single primer system with PWR22 Automotive Glass Cleaner, expressly formulated to be used with any automotive grade urethane, and you have just decreased your installation time. Use CRL9P Pinchweld Primer for bare metal scratches on the pinchweld, and CRL9EP Primer on EPDM/PVC Moldings.



Basic Urethane Application Instructions for Safe Installations



TECH ARTICLE

“PINCHWELD PRIMERS AND RUST PREVENTION”

Available Online at crlaurence.com

1. Confirm correct glass for vehicle before starting.
2. Inspect vehicle for prior damage and inform customer.
3. Remove damaged glass using industry approved methods and tools while wearing safety gloves and glasses.
4. Dry fit glass and mark with alignment tape.
5. Clean around entire pinchweld using plain water. Wipe clean with lint free paper towel to remove dirt and debris before trimming old bead. This prevents contamination of the trimmed bead.
6. Clean new glass with PWR22 Automotive Glass Cleaner, then apply CRL9GC Glass Primer (CRL 900 Series, CRL 700 Series) to the frit and wipe clean with a new lint free paper towel. Allow to dry 10 minutes, but not more than 2 hours before installing adhesive. For cold weather installation, apply in shop or van. Clean new glass with PWR22 Automotive Glass Cleaner, re-apply PWR22 to the frit area and wipe dry (POWR 300 Series).
7. Shake can of PP3UV Primer and UV Blocker (POWR 300 Series) for at least 60 seconds. Apply to bond area and allow to dry 10 to 15 minutes (longer if cold or dry conditions exist).
8. Trim existing urethane bead down to 1/16" (1.5 mm), taking care not to damage painted surface. Touch up any bare metal scratches with CRL9P (CRL900 Series and CRL700 Series) or PP3MP Pinchweld Primer (POWR 300 Series). Do not touch, clean, or prime the top of existing trimmed urethane bead. If any debris comes in contact with the surface of the urethane, wipe away with plain water and clean lint free paper towel.
9. Trim nozzle for desired bead size and gun urethane on pinchweld or glass. CRL suggests using a V-shaped bead and the caulking gun held at a 90° angle to the pinchweld or glass. This technique ‘wets out’ the urethane under pressure for superior bonding.
10. Install glass into opening, without touching the primed surface of the glass. Wear Nitrile gloves and use suction cups. Watch alignment tape and press in on the glass (decking) until OEM alignment of the glass to the body panel is achieved.
11. Note urethane and primer catalog numbers and batch numbers on invoice. Allow required strength build up before returning vehicle to customer, and provide customer with cure rate information from CRL Urethane Cure Rate Chart (see page A105).

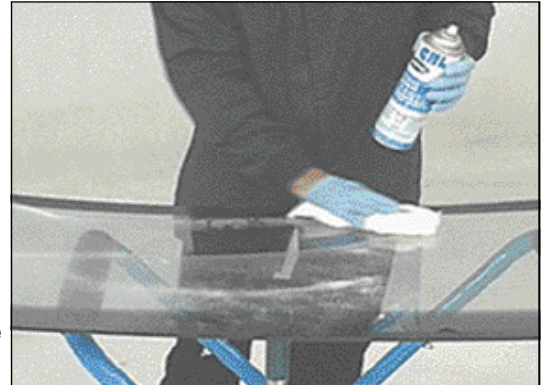

• Instructions for proper use are printed on every cartridge and sausage!



TECH ARTICLE

“RESPONSIBLE INSTALLATIONS”

Available Online at crlaurence.com

Do Not Compromise Safety.



LOG ON TO crlaurence.com FOR BUSINESS-TO-BUSINESS SERVICES

A102 | PHONE (800) 421-6144 | FAX (800) 262-3299 TOLL FREE FROM ANYWHERE IN THE U.S.A. OR CANADA

CRL Cold Weather Procedures for Auto Glass Replacement

• How to Ensure Proper Adhesion When it's Cold Outside

CRL suggests that all cold weather installations be done in an enclosed shop with a controlled environment for both temperature and humidity. When installations are done outside, or in a shop that is not heated, and the temperature is below 40°F (4°C), the following procedures should be taken. In addition, hold the vehicle for a minimum of four to six hours.



1. Before applying, warm standard urethanes to room temperature (75°F/23°C). If using a heated urethane (Cat. No. CRL700), pre-heat the urethane to 185°F/85°C using your urethane heater oven.
2. Run the vehicle's defroster until the glass is warm to the touch on all edges.
3. Pre-prime the new glass in a controlled environment before leaving the shop. Keep glass clean and dry while in transit and prior to installation.
4. After removal of the old glass, make sure the pinchweld is free of contamination, condensation, frost or moisture. Dry with a heat gun if necessary.
5. Before applying the urethane, properly prepare the pinchweld by priming any bare metal scratches and/or repaired rust areas. It is very important to allow all primers to dry in these controlled conditions.
6. After the installation is completed in a non-heated shop, place a small space heater in the vehicle to maintain elevated temperatures and spray a light mist of water on the windshield to raise the relative humidity. Mobile operators should make vehicle owners aware of the need to keep the vehicle warm and moisture levels elevated to ensure curing of the urethane for the next five to seven days.
7. Give information, both verbal and written, to the customer regarding the safety concerns of driving the vehicle prior to a full cure. CRL strongly suggests that an estimated time for full cure be provided to the customer for their safety.

NOTE: Always follow the proper installation procedure for each particular vehicle and each type of urethane. Instructions for use are provided on each cartridge of CRL Urethane, and should always be read carefully before beginning each job. For any questions concerning a particular installation or procedure feel free to contact CRL Automotive Technical Sales by e-mail at techsales@crlaurence.com.



"AUTO GLASS REPLACEMENT"

Available Online at
crlaurence.com

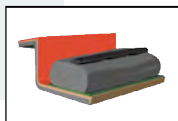

"PROPER CLEANING OF WINDSHIELD BONDING SURFACES"

Available Online at
crlaurence.com



Safe Drive Away Times

CRL provides to our customers, and various trade publications, recommended safe drive away times for our automotive urethanes. These are offered as guidelines only, and are specific to the temperature and humidity levels present during the installation.

Urethane tensile and lap shear tests are performed in the laboratory in controlled conditions to arrive at these recommended safe drive away times. In some instances vehicles are crash tested to quantify these recommendations. Not all vehicles or temperature and humidity levels are tested, nor are all installation circumstances taken into consideration. The laboratory test of the urethane bead is normally open to the atmosphere on two sides, and the minimum 1/4" OEM bead size is used. Vehicle installations have other components that cut off outside atmosphere from the urethane and can slow down the cure rate. Moldings and foam tapes close off the urethane bead on both sides, while the glass and pinchweld close off the top and bottom. Even though the foam tape may be open cell, this still slows down the cure rate.

Each technician should take all of the following factors into consideration when using any urethane manufacturer's recommended safe drive away times. Are you actually checking the temperature and humidity levels that are present at the time of the installation? Is this information noted on your invoices? Is the bead size the 1/4" minimum, or is it larger? Is a foam tape present on this installation?

All of these factors weigh heavily on the ultimate curing of the product.

As a major supplier to the automotive aftermarket, CRL wants to provide as much information as possible to our customers. Our intent is to educate our customers so they are able to confidently shop and purchase quality products for their jobs, using them professionally and safely.



Information and trust are an important part of being a leader in any industry, and CRL is proud to supply the aftermarket with accurate product information and quality products at a fair market value.

If you have any questions regarding this article please contact CRL Technical Sales at (800) 421-6144 in the U.S., or (877) 421-6144 from Canada. Ask for Extension 7700, or e-mail techsales@crlaurence.com.

Importance of Knowing Humidity Levels

How important is it to know humidity levels?

Take a quick look at the chart below. At 95°F and 100% Relative Humidity one cubic meter of atmosphere can support 6 grams of water. The cooler the air gets the less it can support the weight of these heavy molecules. Notice at 70°F and 100% RH the same cubic meter of air can support only three grams of water. Which temperature is going to give you the best and fastest cure when using moisture-curing cold applied urethane?

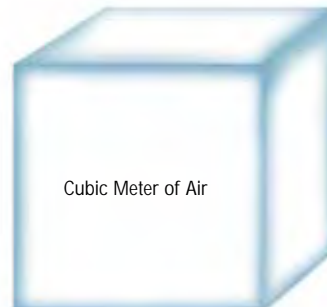

Six Grams of Water @ 95°F (35°C)



Three Grams of Water @ 75°F (24°C)



1.5 Grams of Water @ 55°F (13°C)



Relative Humidity

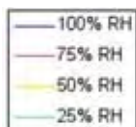
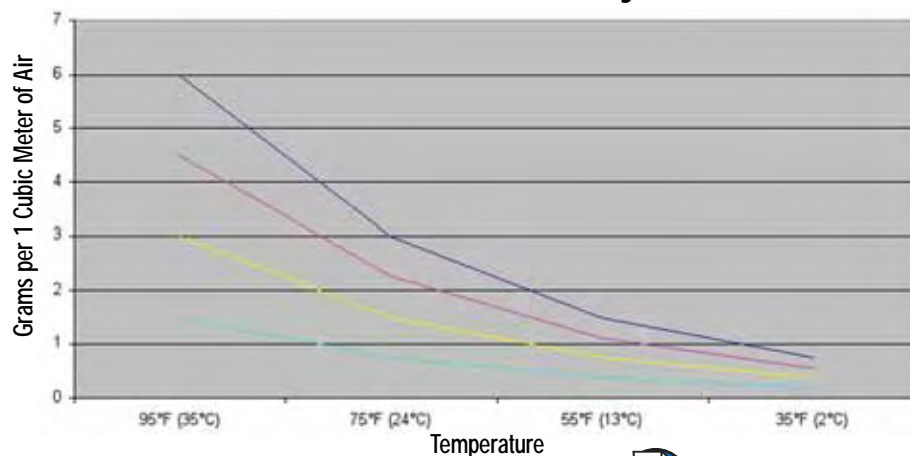

What to do?

When faced with lower temperatures and needing the fastest safe drive away time (higher humidity levels) for your customer there are ways to manipulate the humidity levels to your advantage. In a heated shop, wet down the floor in the morning and again in the afternoon. This will raise the humidity level as the floor dries out. In a mobile situation, carry a small spray bottle with water in it, and just after you have completed the installation (moldings installed) spray around the edges of the windshield. This raises the humidity level in the air even though the water doesn't always touch the urethane bead.



TECH ARTICLE

"CHECKING THE CURE RATE OF AUTOMOTIVE URETHANE"
Available Online at crlaurence.com



LOG ON TO crlaurence.com FOR BUSINESS-TO-BUSINESS SERVICES

A104 | PHONE (800) 421-6144 | FAX (800) 262-3299 TOLL FREE FROM ANYWHERE IN THE U.S.A. OR CANADA

Safe Drive Away Time Recommendations for CRL Urethanes



CRL900HV



CRL915HV
CRL High Viscosity Urethane

HOURS OF CURE TO REACH 50 P.S.I. WITHOUT AIR BAG

TEMPERATURE	95% RH	75% RH	40% RH	15% RH
95°F (29°C)	2	2	2	2
72°F (21°C)	2	2	2	4
55°F (13°C)	3	3	4	24
40°F (4°C)	4	4	24	24

HOURS OF CURE TO REACH 150 P.S.I. WITH AIR BAG

TEMPERATURE	95% RH	75% RH	40% RH	15% RH
95°F (29°C)	8	8	8	8
72°F (21°C)	8	8	8	16
55°F (13°C)	12	12	16	NR
40°F (4°C)	16	16	NR	NR



CRL950FC

CRL Fast Cure High Viscosity Urethane

TEMPERATURE	80% RH	60% RH	40% RH	20% RH
80°F (29°C)	.75	.75	.75	.75
72°F (21°C)	.75	.75	.75	1
60°F (13°C)	.75	.75	1	1.5
40°F (4°C)	1	1	2	2

TEMPERATURE	80% RH	60% RH	40% RH	20% RH
80°F (29°C)	4	4	4	4
72°F (21°C)	4	4	4	12
60°F (13°C)	4	4	8	18
40°F (4°C)	12	12	24	24



PP301HV

POWR Primerless High Viscosity Urethane

TEMPERATURE	90% RH	75% RH	50% RH	25% RH
85°F (29°C)	1	1	1	2
70°F (21°C)	1	2	2	3
55°F (13°C)	3	4	4	6
40°F (4°C)	6	8	9	11

TEMPERATURE	90% RH	75% RH	50% RH	25% RH
85°F (29°C)	2	3	3	4
70°F (21°C)	3	3	3	5
55°F (13°C)	5	5	6	11
40°F (4°C)	10	12	15	18



PP302MV

POWR Primerless Medium Viscosity Urethane

TEMPERATURE	90% RH	75% RH	50% RH	25% RH
85°F (29°C)	2	2	2	3
70°F (21°C)	2	2	3	5
55°F (13°C)	4	4	5	6
40°F (4°C)	6	8	9	11

TEMPERATURE	90% RH	75% RH	50% RH	25% RH
85°F (29°C)	3	4	4	5
70°F (21°C)	4	4	4	6
55°F (13°C)	5	6	6	11
40°F (4°C)	10	12	15	18



PP303HL

POWR Primerless High Modulus/Low Conductive Urethane

TEMPERATURE	90% RH	75% RH	50% RH	25% RH
85°F (29°C)	1	1	1	2
70°F (21°C)	1	2	2	3
55°F (13°C)	3	4	4	6
40°F (4°C)	6	8	9	11

TEMPERATURE	90% RH	75% RH	50% RH	25% RH
85°F (29°C)	2	3	3	4
70°F (21°C)	3	3	3	5
55°F (13°C)	5	5	6	11
40°F (4°C)	10	12	15	18



CRL700

CRL Heated Urethane

TEMPERATURE	100% RH	75% RH	40% RH	15% RH	0% RH
95°F (29°C)	.5	.5	.5	.5	NR
72°F (21°C)	.5	.5	.5	NR	NR
55°F (13°C)	.5	.5	.5	NR	NR
35°F (4°C)	2	2	NR	NR	NR

TEMPERATURE	100% RH	75% RH	40% RH	15% RH	0% RH
95°F (29°C)	4	4	4	4	NR
72°F (21°C)	4	4	4	NR	NR
55°F (13°C)	8	8	24	NR	NR
35°F (4°C)	24	24	NR	NR	NR

NR=Not Recommended

NR=Not Recommended



CRL Cross Brand Tech Comparison Chart HIGH VISCOSITY URETHANES

BRAND NAME	PASSED FMVSS	MEETS FMVSS	MINIMUM DRIVE AWAY TIME WITH AIR BAG	LAP SHEAR @ DRIVE AWAY	LAP SHEAR @ ULTIMATE CURE TIME	TENSILE STRENGTH @ 7 DAYS	URETHANE CAT.NO.	PRIMER CAT. NO.	PRIMER DESCRIPTION
CRL CRL900HV HIGH VISCOSITY	#208 #212 OEM*	#208 #212 OEM*	8 HOURS @ 72°F 50% RH	N/A	650 PSI	1200 PSI	CRL900HV Cartridge CRL915HV Sausage	CRL9GC CRL9P CRL9EP	GLASS PREP PINCHWELD EPDM/PVC
CRL POWR 300 PRIMERLESS HIGH VISCOSITY	#218 #212 #216 OEM*	#218 #212 #216 OEM*	3 HOURS @70°F 50%RH	150 PSI W / AIR BAGS	>550 PSI	>1000 PSI	PP301HV	PP3MP PP3UV	PINCHWELD UV BLOCKER AND EPDM/PVC
ESSEX U400HV HIGH VISCOSITY		#212 #216 OEM*	4 HOURS @70°F 50%RH	N/A	>500 PSI	>1000 PSI	U400HV	U5500 U5404	GLASS PREP PINCHWELD
ESSEX U418HV QUICK CURE		#208 #212	8 HOURS @70°F 50%RH	N/A	>500 PSI	>700 PSI	U418HV	U5404	PINCHWELD
TITAN 2000HV FAST CURING	#208 #212	#208 #212 #216	3 HOURS @70°F 50%RH	150 PSI W / AIR BAGS	>550 PSI	>1000 PSI	T2000HV	W1P40 GP60	PINCHWELD EPDM/PVC
TITAN 660 HIGH MODULUS	#212	#208 #212 #216 OEM*	4 HOURS @70°F 50%RH	150 PSI W / AIR BAGS	>550 PSI	>1000 PSI	T660	W1P40 GP60	PINCHWELD EPDM/PVC
TITAN 800EM CARLITE APPROVED	#212	#208 #212 #216 OEM*	5 HOURS @70°F 50%RH	150 PSI W / AIR BAGS	>700 PSI	>1000 PSI	T800EM	W1P40 GP60	PINCHWELD GLASS AND EPDM/PVC
3M8690 FAST CURE	#212@ 4 HOURS	#212 #216 OEM*	7 HOURS @70°F 50%RH	150 PSI W / AIR BAGS	>500 PSI	1000 PSI	3M8690	3M8681	GLASS AND PINCHWELD
3M8696 HIGH VISCOSITY		#212 #216 OEM*	8 HOURS @70°F 50%RH	150 PSI W / AIR BAGS	>500 PSI	1000 PSI	3M8696	3M8681	GLASS AND PINCHWELD
SIKA SIKAFLEX-220+	#208 #212 OEM*	#208 #212 OEM*	8 HOURS @73°F 50%RH	NOT SUPPORTED	600 PSI	1100 PSI	S1KA220	60D960 S1KA206GP S1KA21530	GLASS PREP PINCHWELD EPDM/PVC

*OEM - In lieu of product's meeting FMVSS 212, 216, and 208 those products marked "OEM" meet or exceed OEM specifications standards for glazing a vehicle's glass.



F.M.V.S.S.
FEDERAL MOTOR VEHICLE SAFETY STANDARDS:
Complete Definitions
Available Online at
crlaurence.com



"UNDERSTANDING URETHANE PRIMERS"
Available Online at
crlaurence.com



LOG ON TO crlaurence.com FOR BUSINESS-TO-BUSINESS SERVICES

A106 | PHONE (800) 421-6144 | FAX (800) 262-3299 TOLL FREE FROM ANYWHERE IN THE U.S.A. OR CANADA

CRL Cross Brand Tech Comparison Chart

MEDIUM VISCOSITY URETHANES

BRAND NAME	PASSED FMVSS	MEETS FMVSS	MINIMUM DRIVE AWAY TIME WITH AIR BAG	LAP SHEAR @ DRIVE AWAY	LAP SHEAR @ ULTIMATE CURE TIME	TENSILE STRENGTH @ 7 DAYS	URETHANE CAT. NO.	PRIMER CAT. NO.	PRIMER DESCRIPTION
CRL POWR 300 PRIMERLESS MEDIUM VISCOSITY	#218 #212 #216 OEM*	#218 #212 #216 OEM*	4 HOURS @70°F 50%RH	150 PSI W / AIR BAGS	>550 PSI	>1000 PSI	PP302MV	PP3MP PP3UV	PINCHWELD UV BLOCKER AND EPDM/PVC
ESSEX U418 QUICK CURE		#208 #212	8 HOURS @70°F 50%RH	N/A	>500 PSI	>700 PSI	U418	U5500 U5404	GLASS PRIMER PINCHWELD
ESSEX EXPRESS ADVANCED CURE	#212 OEM*	#208 #212	1 HOUR @72° F 50% RH	N/A	>8.4 MPa	>1000 PSI	U208HV	U5500 U5404	GLASS PRIMER PINCHWELD
TITAN 1000 FAST CURE	#212	#208 #212 #216	3 HOURS @70°F 50%RH	150 PSI W / AIR BAGS	>550 PSI	>1000 PSI	T1000	W1P40 GP60	PINCHWELD EPDM/PVC
TITAN 380 QUICK CURING	#212	#208 #212 #216 OEM*	4 HOURS @70°F 50%RH	150 PSI W / AIR BAGS	<550 PSI	>1000 PSI	T380	W1P40 GP60	PINCHWELD EPDM/PVC
3M8693 MEDIUM VISCOSITY		#212 #216 OEM*	8 HOURS @70°F 50%RH	150 PSI W / AIR BAGS	500 PSI	1200 PSI	3M8693	3M8681	GLASS AND PINCHWELD
3M8609 SUPER FAST		#212 #216 OEM*	8 HOURS @70°F 50%RH	150 PSI W / AIR BAGS	500 PSI	1200 PSI	3M8609	3M8681	GLASS AND PINCHWELD

*OEM - In lieu of product's meeting FMVSS 212, 216, and 208 those products marked *OEM* meet or exceed OEM specifications standards for glazing a vehicle's glass.

Urethane Adhesives

Pages A110-A123



Other Adhesives and Sealants

Pages A124-A129



Cleaners and Lubricants

Pages A148-A163



Caulking Guns

Pages A140-A143



LOG ON TO crlaurence.com FOR BUSINESS-TO-BUSINESS SERVICES

PHONE (800) 421-6144 | FAX (800) 262-3299 TOLL FREE FROM ANYWHERE IN THE U.S.A. OR CANADA | A107



CRL Cross Brand Tech Comparison Chart

NON - OR - LOW - CONDUCTIVE, COLD-APPLIED URETHANES

BRAND NAME	PASSED FMVSS	MEETS FMVSS	MINIMUM DRIVE AWAY TIME WITH AIR BAG	LAP SHEAR @ DRIVE AWAY	LAP SHEAR @ ULTIMATE CURE TIME	TENSILE STRENGTH @ 7 DAYS	URETHANE CAT. NO.	PRIMER CAT. NO.	PRIMER DESCRIPTION
CRL CRL950FC NON-CONDUCTIVE	#208 #212 OEM*	#208 #212 OEM*	4 HOURS @72°F 50% RH	N/A	>500 PSI	>800 PSI	CRL950FC	CRL9GC CRL9P CRL9EP	GLASS PREP PINCHWELD EPDM/PVC
CRL POWR 300 PRIMERLESS HIGH MODULUS LOW CONDUCTIVE	#218 #212 #216 OEM*	#218 #212 #216 OEM*	3 HOURS @70°F 50%RH	150 PSI W / AIR BAGS	>550 PSI	>1000 PSI	PP303HL	PP3MP PP3UV	PINCHWELD UV BLOCKER AND EPDM/PVC
ESSEX BETASEAL 1502 HMNC HIGH MODULUS NON CONDUCTIVE		#208 #212	8 HOURS @70°F 50%RH	N/A	>500 PSI	700 PSI			GLASS PREP GLASS PRIMER PINCHWELD
SIKA TACK-DRIVE	#208 #212 OEM*		4 HOURS @73°F 50%RH	NOT SUPPORTED	>500 PSI	>800 PSI	271243	60D960 S1KA206GP S1KA21530	GLASS PREP PINCHWELD EPDM/PVC
SIKA TACK HIGH MODULUS		#208 #212	3 HOURS @70°F 50%RH	NOT SUPPORTED	600 PSI	1100 PSI		60D960 S1KA206GP S1KA21530	GLASS PREP PINCHWELD EPDM/PVC

*OEM - In lieu of product's meeting FMVSS 212, 216, and 208 those products marked "OEM" meet or exceed OEM specifications standards for glazing a vehicle's glass.

HEATED URETHANES

BRAND NAME	PASSED FMVSS	MEETS FMVSS	MINIMUM DRIVE AWAY TIME WITH AIR BAG	LAP SHEAR @ DRIVE AWAY	LAP SHEAR @ ULTIMATE CURE TIME	TENSILE STRENGTH @ 7 DAYS	URETHANE CAT. NO.	PRIMER CAT. NO.	PRIMER DESCRIPTION
CRL700 HEATED	#208 #212 OEM*	#208 #212 OEM*	4 HOURS @72°F 50% RH	N/A	700 PSI	900 PSI	CRL700	CRL9GC CRL9P CRL9EP	GLASS PREP PINCHWELD EPDM/PVC
SIKA TACK-ASAP NON-CONDUCTIVE		#218 #212 #216 OEM*	1.75 HOURS @72°F 50% RH	NOT SUPPORTED	>500 PSI	>775 PSI	270243	60D960 S1KA206GP S1KA21530	GLASS PREP PINCHWELD EPDM/PVC
SIKA TACK ULTRAFAST II NON-CONDUCTIVE		#212 #216	2 HOURS @72°F 50% RH	NOT SUPPORTED	>500 PSI	>800 PSI	26924P	60D960 S1KA206GP S1KA21530	GLASS PREP PINCHWELD EPDM/PVC

*OEM - In lieu of product's meeting FMVSS 212, 216, and 208 those products marked "OEM" meet or exceed OEM specifications standards for glazing a vehicle's glass.

Data for the CRL Cross Brand Tech Comparison Chart was compiled in August 2004 from manufacturers' documents, catalogs, and verbal reports. Laboratory test methods may vary among suppliers, thereby making direct comparisons difficult. Additional specification data is available online at crlaurence.com.



Certification Testing

- All CRL Urethane Systems Are Part of the LYNX Services Quality Adhesive Program
- Certification Testing Online Via the CRL Web Site
- Pass the Test and Receive a Certificate Suitable for Mounting

Certification testing for auto glass professionals using CRL Automotive Urethanes is available online at crlaurence.com. Visit our web site for information about and access to our online test. After submitting and passing the test, a certificate suitable for mounting will be sent to you via certified mail.



CRL 900HV Series High Viscosity Quick Cure Urethane Adhesive

- Meets or Exceeds U.S. Federal Motor Vehicle Safety Standards 208 and 212, and OEM Strength Requirements
- Value Priced, Quick Curing, Cold-Applied
- Part of the LYNX Services Program
- Glass Primer Must Be Used

new



- V-Cut and Cone Nozzles Included with Cartridges and Sausages

CRL 900HV Series High Viscosity Urethane is a quick curing adhesive that passes or exceeds U.S. FMVSS 208 and 212. Quick curing and high viscosity are features you normally find in higher priced urethanes, but CRL offers these same features in our competitively priced CRL900HV. Available in metal cartridges with screw-on V-Cut and cone nozzles, or sausage packs with sausage gun nozzles.

Our new sausage packs provide enough material to complete 98% of the windshields in today's vehicles using a single pack, and they cost less per ounce to use than cartridges. Easier to gun using standard sausage pack caulking guns because nozzles are 25% larger than standard cartridge nozzles. Completely used sausages are more easily disposed of than aluminum cartridges.

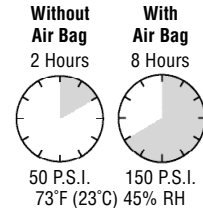

Refer to Pages A105-A108 for Safe Drive Times and Complete Tech Chart.



See pages A140-A143 for our complete line of caulking guns.



CAT. NO.	CONTENTS	QTY/CASE
CRL900HV	10.5 Fl. Oz. (310 ml) Cartridge	24
CRL915HV	15.2 Fl. Oz. (450 ml) Sausage	24

All automotive sealants can be combined for quantity pricing.

CRL 950FC Series Fast Cure High Viscosity Urethane Adhesive

- Meets or Exceeds U.S. Federal Motor Vehicle Safety Standards 208 and 212, and OEM Strength Requirements
- Fast Curing Adhesive at a Great Price
- Part of the LYNX Services Program
- Glass Primer Must Be Used

new



- V-Cut and Cone Nozzles Included with Cartridges

CRL 950FC Series Fast Cure Urethane Adhesive passes or exceeds U.S. FMVSS 208 and 212. Guns smoothly, is non-sagging, provides a sure bond, and rates non-conductive. CRL950FC is value priced for most competitive markets. Available in metal cartridges with screw-on V-Cut and cone nozzles.

This new Fast Cure adhesive is formulated for cold application (no pre-heating is required) and offers Safe Drive Away Time in as little as 45 minutes. CRL 900 Series Urethanes require only the CRL9GC Glass Primer, which chemically reacts with the glass frit and urethane to provide a more reliable bond. One primer eliminates a possible source of error of using additional blackout primers, and is more cost effective.

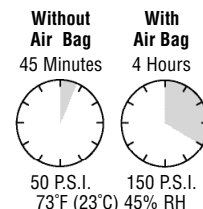

Refer to Pages A105-A108 for Safe Drive Times and Complete Tech Chart.



CAT. NO.	CONTENTS	QTY/CASE
CRL950FC	10.5 Fl. Oz. (310 ml) Cartridge	24

All automotive sealants can be combined for quantity pricing.

NOTE: CRL9GC Glass Primer must be used prior to application of CRL 900 and CRL 700 Series Urethanes to prevent glass displacement. Failure to do so may result in personal injury or property damage.



LOG ON TO crlaurence.com FOR BUSINESS-TO-BUSINESS SERVICES

A110 | PHONE (800) 421-6144 | FAX (800) 262-3299 TOLL FREE FROM ANYWHERE IN THE U.S.A. OR CANADA

CRL Glass Primer for CRL 900 and CRL 700 Series Urethanes

- Glass Primer Required for a Secure Bond

CRL9GC Glass Primer chemically reacts with the glass frit and urethane to provide a secure bond. Clean new glass first with PWR22 Automotive Glass Cleaner, and then apply CRL9GC to the frit with a lint-free wipe. No need for any additional blackout primer. If the glass is supplied without black ceramic frit, paint the edges with CRL9P Pinchweld Primer.



CAT. NO.	CONTENTS	QTY/CASE
CRL9GC	8.3 Fl. Oz. (250 ml)	6

All Primers can be combined for quantity pricing.

CRL Pinchweld Primer for CRL 900 and CRL 700 Series Urethanes

- Use on Bare Metal Scratches

Pinchweld Primer should be used on bare pinchweld metal scratches or rust areas that have been properly repaired prior to priming. May also be used on glass supplied without black ceramic frit to improve adhesion.



CAT. NO.	CONTENTS	QTY/CASE
CRL9P	8.3 Fl. Oz. (250 ml)	6

All Primers can be combined for quantity pricing.

CRL EPDM/PVC Primer for CRL 900 and CRL 700 Series Urethanes

- For Use with Rigid and Semi-Rigid EPDM and PVC Encapsulated Parts

New encapsulated parts require a primer for OEM bonding strength when urethane is being bonded to the encapsulation rather than to the glass. EPDM and PVC encapsulated parts cannot be bonded to the body using normal primers. Select this primer for a sure bond in these cases.



CAT. NO.	CONTENTS	QTY/CASE
CRL9EP	1 Fl. Oz. (30 ml)	6

All Primers can be combined for quantity pricing.

CRL POWR Cleaner

- Formulated for Use with All Auto Glass Urethanes and Primers
- Faster and Less Expensive Than Brush-On Conditioners
- You've Got to Try It!



CRL POWR Cleaner is an aerosol glass cleaner especially formulated to properly clean auto glass for the application of urethane adhesives and primers. Use it to clean the entire windshield, especially around the perimeter where you would normally use a brush-on Glass Conditioner (consult individual manufacturer's Technical Data Sheets for specific recommendations). Lab tested for superior cleaning, it's compatible with all CRL Primers. POWR Cleaner is faster and less expensive per use, so you save both time and money while you prepare the glass for maximum bond to the urethane.

CAT. NO.	CONTENTS	QTY/CASE
PWR22	19 Oz. (539 g)	12 Cans

Can be combined with CRL Glass Cleaners for quantity pricing.

CRL POWR Clean Frit Kit

- Removes Windshield Contamination
- Will Not Scratch Glass or Black Frit

This kit was developed for removing bond inhibiting contaminants. It combines PWR22 POWR Cleaner, special 4" x 8" Open Cell Nylon Pads, and durable nylon reinforced 1550 Shop Wipes.

Simply spray POWR Cleaner on the glass. When the cleaner "beads up" you have contaminants. Scrub the suspect contaminants with the Open Cell Nylon Pads, then clean again with POWR Cleaner and 1550 Shop Wipes. If "beading" is still present, the glass should be returned to the vendor. Pads will not scratch glass or black frit.



Kit includes: 20 Open Cell Nylon Pads, one can of PWR22 POWR Cleaner and 50 Shop Wipes. NP48 Replacement Open Cell Pads are packaged 50 per pack.

CAT. NO.	DESCRIPTION
FK1T2	POWR-Clean Frit Kit (Cleaner, Pads, Wipes)
PWR22	POWR Cleaner (19 Oz. Cans/12 per case)
NP48	4" x 8" Open Cell Pads (50/Pack)
1550	Lint-Free Shop Wipes (900 Wipes per case)

CRL POWR Primerless 301HV High Viscosity Urethane Adhesive

- Primerless to Auto Glass Frit
- Rates Non-Conductive, High Modulus
- Accelerated Cure
- Part of the LYNX Services Program

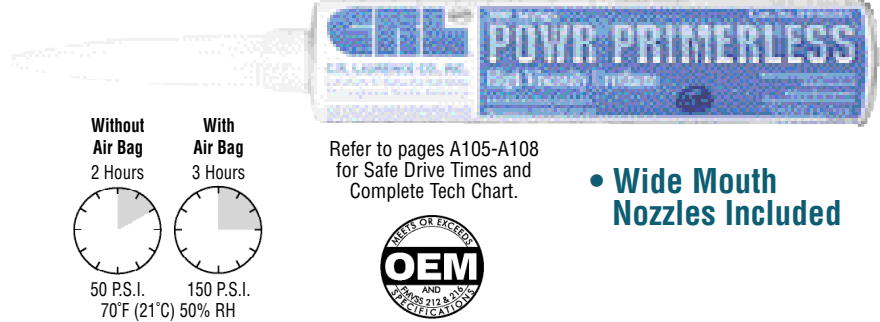

This primerless to auto glass frit High Viscosity Urethane is a high quality adhesive that passes or exceeds the requirements of U.S. Federal Motor Vehicle Safety Standards 208, 212, and 216, as well as OEM specifications. With over 1,000 psi of tensile strength and 550 psi lap shear at ultimate cure, PP301HV is one of the safest and strongest urethanes offered for the aftermarket. This urethane has a new Aggressive Adhesion Formula that has proven itself to aggressively bond to all automotive glass frits without the need for a glass primer. Designed to support auto glass without the use of dam tape. Long term exposure testing confirms that the new formula stands up to the harshest environmental conditions.

CAT. NO.	CONTENTS	QTY/CASE
PP301HV	10.5 Fl. Oz. (311 ml)	24

All automotive sealants can be combined for quantity pricing.

POWR 300 Series is formulated without isocyanates. As a result, this new formulation produces a by-product of moisture in the curing process, accelerating the curing process and providing faster safe drive away times.

In addition to these features, POWR 300 Series Urethane has a new wide mouth cartridge that provides a 60% larger nozzle opening than standard cartridges, enabling an increased flow of the material with less force. Re-engineered nozzles supplied with POWR 300 Series Urethane are designed for easy trimming to accommodate back filling operations. They can also be trimmed further to produce a full round bead. The V-Notch indentation can be used for trimming the nozzle for the proper urethane bead dispensing height.



CRL POWR Primerless 302MV Medium Viscosity Urethane Adhesive

- Primerless to Auto Glass Frit
- Medium Modulus
- Accelerated Cure
- Part of the LYNX Services Program

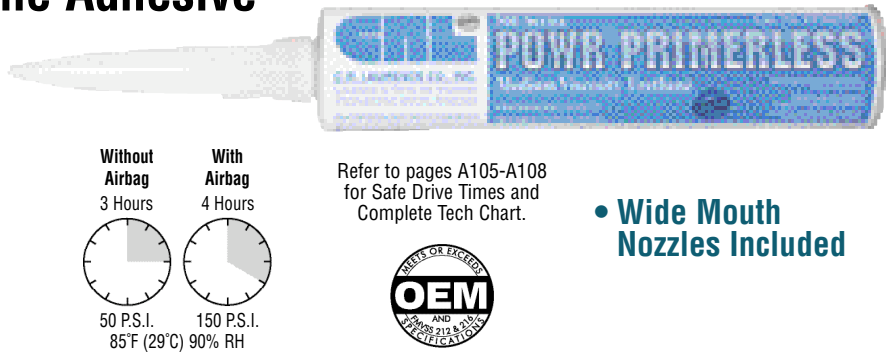

This primerless to auto glass frit Medium Viscosity Urethane is a high quality adhesive that passes or exceeds the requirements of U.S. Federal Motor Vehicle Safety Standards 208, 212, and 216, as well as OEM specifications. PP302MV has over 1,000 psi of tensile strength and 550 psi lap shear at ultimate cure. This urethane has a new Aggressive Adhesion Formula that has proven itself to aggressively bond to all automotive glass frits without the need for a glass primer. The easy gunning viscosity is great for back filling gasket set glass or, if used with foam sound tapes, saves the cost of using a high viscosity product. Long term exposure testing confirms that the new formula stands up to the harshest environmental conditions.

CAT. NO.	CONTENTS	QTY/CASE
PP302MV	10.5 Fl. Oz. (311 ml)	24

All automotive sealants can be combined for quantity pricing.

POWR 300 Series is formulated without isocyanates. As a result, this new formulation produces a by-product of moisture in the curing process, accelerating the curing process and providing faster safe drive away times.

POWR 300 Series Urethane has a new wide mouth cartridge that provides a 60% larger nozzle opening than standard cartridges, making possible an increased flow of the material with less force. The V-Notch indentation can be used for trimming the nozzle for the proper urethane bead dispensing height. Nozzles are designed for easy trimming to accommodate back filling operations, or to be trimmed further to produce a full round bead.



LOG ON TO crlaurence.com FOR BUSINESS-TO-BUSINESS SERVICES

A112 | PHONE (800) 421-6144 | FAX (800) 262-3299 TOLL FREE FROM ANYWHERE IN THE U.S.A. OR CANADA

CRL POWR Primerless 303HL High Modulus/Non-Conductive Urethane Adhesive

- Primerless to Auto Glass Frit
- High Modulus, Non-Conductive
- Accelerated Cure
- Part of the LYNX Services Program
- Wide Mouth Nozzles Included

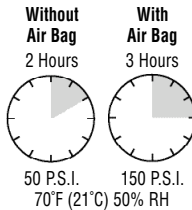

Refer to pages A105-A108 for Safe Drive Times and Complete Tech Chart.



This primerless to auto glass frit high modulus/non-conductive urethane is a high quality adhesive that passes or exceeds the requirements of U.S. Federal Motor Vehicle Safety Standards 208, 212, and 216, as well as OEM specifications. With over 1,000 psi of tensile strength, and 550 psi lap shear at ultimate cure, PP303HL is one of the safest and strongest urethanes available.

Virtually all European vehicles have specifications for High Modulus Urethane to be used when replacement glass is required. Additionally, aluminum bodied vehicles require low conductive urethane to prevent electrical current from passing from the glass to the body and creating corrosion. The Non-Conductive aspect of the formula is also required for glass with embedded electronic devices.

High Modulus is completely different from High Viscosity because the High Modulus specification is the physical property of the material after it has cured (stiffness), where the High Viscosity specification is the physical property of the material in the liquid state (thickness). In the circumstance where this material is required for rigidity, it is very important, as the driving characteristics of the vehicle could be altered by not using a High Modulus Urethane.

PP303HL has a new Aggressive Adhesion Formula that has proven itself to aggressively bond to all automotive glass frits without needing a glass primer. Long term exposure testing confirms that the new formula stands up to the harshest environmental conditions. POWR 300 Series is also formulated without isocyanates. As a result, this new formulation produces a by-product of moisture in the curing process, accelerating the curing process and providing faster safe drive away times.

POWR 300 Series Urethane comes in a new wide mouth cartridge that provides a 60% larger nozzle opening than standard cartridges, enabling improved flow with less force. Nozzles supplied with POWR 300 Series Urethane are designed for easy trimming to accommodate back filling operations. They can also be trimmed further to produce a full round bead. The V-Notch indentation can be used for trimming the nozzle for the proper urethane bead dispensing height.

CAT. NO.	CONTENTS	QTY/CASE
PP303HL	10.5 Fl. Oz. (311 ml)	24

All automotive sealants can be combined for quantity pricing.

CRL POWR 300 Series Pinchweld Primer

- Improves Adhesion of POWR 300 Series Urethanes

To improve adhesion to repaired rust areas and repainted pinchwelds, or to touch up bare metal scratches, use our PP3MP Pinchweld Primer.

CAT. NO.	CONTENTS	QTY/CASE
PP3MP	6 Fl. Oz. (177 ml)	6

Primer and UV Blocker can be combined for quantity pricing.



CRL POWR 300 Series Primer and UV Blocker

- Protects Against UV

Use our PP3UV Primer and UV Blocker if the glass does not have a black frit to protect against UV rays. Also promotes adhesion if bonding to EPDM/PVC moldings.

CAT. NO.	CONTENTS	QTY/CASE
PP3UV	6 Fl. Oz. (177 ml)	6

Primer and UV Blocker can be combined for quantity pricing.



CRL 700 Heated Urethane Adhesive

- Heat Accelerated Curing Provides Fast, Safe Drive Away Times
- Meets U.S. Federal Motor Vehicle Safety Standards 212 and 208 in 1/2 Hour
- Part of the LYNX Services Program

CRL 700 is specially formulated as a safe, fast alternative to room temperature applied one-component urethanes. CRL 700 Heated Urethane accelerates the curing of the material to provide you with fast, safe driving release times for customers who demand their vehicle back quickly. CRL 700 meets or exceeds FMVSS 212 and 208 in approximately 30 minutes, and rates non-conductive. Recommended for use with our Urethane Heater Ovens (see next page) for quick heating.



- V-Cut and Cone Nozzles Included

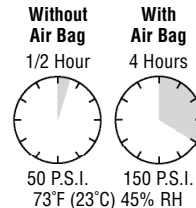

Refer to Pages A105-A108 for Safe Drive Times and Complete Tech Chart.

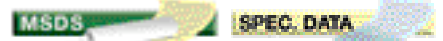

CAT. NO.	CONTENTS	QTY/CASE
CRL700	10.5 Fl. Oz. (310 ml)	12

All automotive sealants can be combined for quantity pricing.

Cleaning and Conditioning Sequence for CRL 900 Series and CRL 700 Urethane Adhesives

- Use PWR22 Automotive Glass Cleaner to clean the interior of the glass.
 - Apply CRL9GC Glass Primer with a dauber or lint-free wipe, and wipe off while still in a liquid state.
 - No additional black primer is needed to glass with frit.
 - Touch up any bare metal scratches on the pinchweld with CRL9P Pinchweld Primer.
- NOTE:** Do not apply Primer on top of the old urethane. For bonding to EPDM/PVC molding, use CRL9EP Primer.

Low Prices for Pallet Buyers of Quality CRL Urethanes



If you use lots of urethane, we have a deal for you. Quality CRL 900 Series, CRL 700, and POWR 300 Series Urethanes are available at special discounts when you buy it by the pallet. Full pallets contain 1,440 10.5 Fl. Oz. cartridges (60 cases of 24), and ship F.O.B. CRL warehouses. Contact your CRL Sales Representative, or CRL Technical Sales for details.

CRL Daubers

- For Smooth, Quick Application of Glass or Pinchweld Primers

CRL Primer Daubers are a thick tuft of wool fibers on the end of a rigid metal wire.

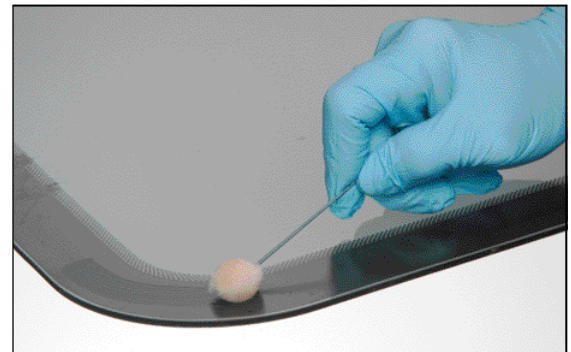

CAT. NO.	QTY/TUB
PT1U409	100

Minimum order: 100 each. Must order in increments of 100.

CRL 6" Disposable Brush

- Natural Horsehair Bristles
- Perfect for Applying Primers



The CRL 6" Disposable Brush applies primers, acids, and flux. They are 6" (152 mm) long, with a 3/8" (9.5 mm) round rolled steel handle, and 3/4" (19 mm) stiff horsehair bristles. Minimum order is 24 each.

CAT. NO. 1AB

CRL Cotton Swabs with Wooden Shafts

new

- Perfect for Applying Pinchweld Primers

CRL Cotton Swabs with Wooden Shafts make applying pinchweld primers to small scratches easier than using wool daubers. They can be used with all brands of pinchweld primers. Minimum order is 100 each.

CAT. NO. 1CS

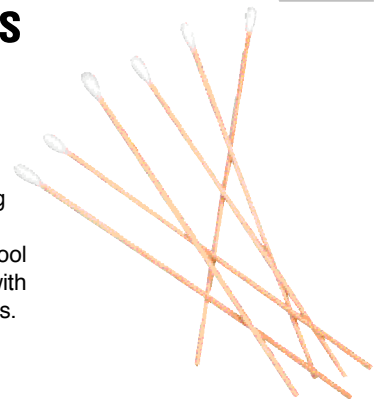

LOG ON TO crlaurence.com FOR BUSINESS-TO-BUSINESS SERVICES

A114 | PHONE (800) 421-6144 | FAX (800) 262-3299 TOLL FREE FROM ANYWHERE IN THE U.S.A. OR CANADA

CRL Urethane Heater Ovens

- Preheats Urethane to Desired Working Temperature in One Hour
- Available in 120V AC or 12V DC Models

CRL Urethane Heater Ovens are designed to warm CRL 700 Heated Urethane and other manufacturers' heated urethanes to the ideal application temperature of 185°F (85°C) within one hour. The two-hole or six-hole design allows you to heat a sufficient amount of material for a single windshield replacement.

Can be purchased separately as shown here, or save money when purchased as part of a Heater Oven Starter Kit.



new

- One Hour Heat Cycle
- Two or Six Cartridge Capacity

CAT. NO.	DESCRIPTION	CAPACITY
E9007	12V DC Oven	2 Cartridges
E9006	120V AC Oven	2 Cartridges
E9011	120V AC Oven	6 Cartridges

CRL Heater Oven Starter Kits

- Everything You Need to Use CRL 700 Heated Urethane Adhesive for Fast, Safe Drive Away Times
- Choose From Three Kits

new

If fast drive away times are your goal, our Heater Oven Starter Kits just might be the answer for you. They provide everything you need to use CRL 700 Heated Urethane Adhesive. Each kit contains 48 cartridges of CRL 700 Heated Urethane, one 8.3 ounce bottle of CRL9GC Glass Primer, one 8.3 ounce bottle of CRL9P Pinchweld Primer, and one of three available ovens. Select from a 12V DC Oven with two holes, or a 120V AC Oven with two or six holes.



CAT. NO.	DESCRIPTION	CAPACITY
E97K	Kit with 12V DC Oven	2 Cartridges
E96K	Kit with 120V AC Oven	2 Cartridges
E91K	Kit with 120V AC Oven	6 Cartridges

CRL Portable Hot/Cold Chests

- Preheats Up to 24 Cartridges of Urethane
- Provides Accelerated Cures in Cold Weather



Model P20S Portable Heater Chest can easily keep up to 24 cartridges of urethane heated to 95°F (35°C). Trim design allows it to fit between the seats or even behind the seat. Operating off of a 12V DC cigarette lighter receptacle, or the available 110V AC/12V DC Multi-Purpose Power Converter, this chest can be used mobile or in the shop.

Also available is CRL Model P20C Portable Hot and Cold Chest. It has the same features as the P20S, but with the ability to chill items to 40° below ambient temperatures, or heat to 135°F (57°C). Both units come with a six foot power cord.

CAT. NO.	DESCRIPTION
P20S	Compact Heater Chest 12V DC
P20C	Compact Hot/Cold Chest 12V DC
PAC15	110V AC to 12V DC Converter



CRL Electronic Heating/Cooling Chest

- Use it to Warm Cartridges or Keep Food and Beverages Cool
- Works on Your Vehicle's 12 Volt DC Power

The CRL Electronic Heating/Cooling Chest plugs into any 12 Volt DC cigarette lighter outlet. Use it to keep caulking cartridges warm before gunning, or to keep food and beverages cool at the job site. Maximum interior temperature range is 125° to 135°F (52° to 57°C); holds cooling 40° below exterior (ambient) temperature. 32 quart capacity; includes detachable 10 foot power cord.



CAT. NO.	DESCRIPTION
P24A	Electronic Heating/Cooling Chest

CRL SikaTack® - Drive Urethane Adhesive

- Fast Curing with High Initial Strength
- Meets FMVSS 208/212 in as Little as 45 Minutes
- Comes with Single Use Aktivator Pads and Primer Stix

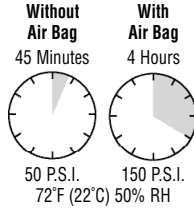

SikaTack® Drive is one of the most popular Sika® products being used nationwide. This product is cold applied, and produces safe drive times in as little as 45 minutes. When used with the included Sika® Aktivator Pads and Sika®Primer-206 Stix, this system provides all you need for a safe and secure installation. SikaTack® - Drive Super Kit ships with 17 Aktivator Pads and 16 Sika®Primer-206 Applicator Stix in a case of 24 cartridges.

CAT. NO.	CONTENTS	QTY/CASE
271243	10.5 Fl. Oz. (311 ml) Cartridge	24

Minimum order is case quantity. All automotive sealants can be combined for quantity pricing.

CRL SikaTack® - ASAP Heated Urethane Adhesive

- 30 Minute Safe Drive Times
- Pre-Cured by Heat
- Comes with Single Use Aktivator Pads and Primer Stix

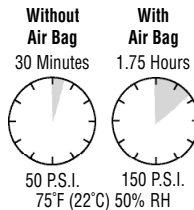

See Page A115 for Urethane Heater Ovens.

SikaTack® ASAP (Any Season, Any Place) has been formulated for use in temperatures down to 0°F (-18°C) and still provide a 30 minute safe drive time. This material must be heated in our Urethane Heater Ovens to provide the chemical reaction for this quick cure. Use Sika® Aktivator Pads as directed for a secure bond. SikaTack® - ASAP Super Kit ships with 17 Aktivator Pads and 16 Sika®Primer-206 Applicator Stix in a case of 24 cartridges.



CAT. NO.	CONTENTS	QTY/CASE
270243	10.5 Fl. Oz. (311 ml) Cartridge	24

Minimum order is case quantity. All automotive sealants can be combined for quantity pricing.

CRL SikaTack® - UltraFast II Heated Urethane Adhesive

- Meets FMVSS 208/212 in as Little as 30 Minutes
- Pre-Cured by Heat / Fast Curing
- Comes with Single Use Aktivator Pads and Primer Stix

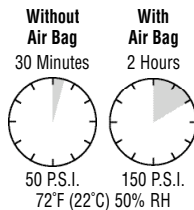

See Page A115 for Urethane Heater Ovens.

SikaTack® - Ultrafast II Urethane represents the next generation of the Ultrafast formula. You can expect faster cure rates (30 minute drive times), at lower temperatures, even down to 0°F (-18°C). SikaTack® Ultrafast II Super Kit ships with 17 Aktivator Pads and 16 Sika® Primer-206 Applicator Stix in a case of 24 cartridges.



CAT. NO.	CONTENTS	QTY/CASE
26924P	10.5 Fl. Oz. (311 ml) Cartridge	24

Minimum order is case quantity. All automotive sealants can be combined for quantity pricing.

CRL SikaTack® - HighModul Urethane Adhesive

- Primerless Application
- Compatible with Glass-Mounted Antennas
- Electrically Non-Conductive Formula for Aluminum-Bodied Vehicles

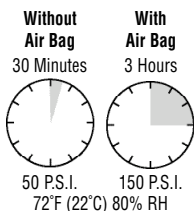

new

SikaTack®-HighModul is a cold-applied automotive glass repair adhesive with a high modulus of shear. Ensures top-quality signal reception from glass-mounted radio antennas, and is also formulated to cause no galvanic corrosion when used on aluminum-bodied vehicles. Ideal where the manufacturer has specified the use of a high modulus direct glazing system, such as in many later model Volkswagen, Audi, and other imported vehicles.



CAT. NO.	CONTENTS	QTY/CASE
B70G520	10.5 Fl. Oz. (311 ml) Cartridge	24

Minimum order is case quantity. All automotive sealants can be combined for quantity pricing.



CRL SikaFlex® 220+ Fast Curing Urethane Adhesive

- Fast Curing Windshield Adhesive
- Non-Corrosive One-Part High Viscosity Formula

CRL SikaFlex® 220+ is a fast curing, flexible, high performance, polyurethane-based adhesive for bonding windshields to vehicle body shells (direct glazing). Its initial strength is derived from its high viscosity upon application. The excellent non-sag properties grab and hold the glass while the material cures. In order to ensure that manufacturer's standards are met S1KA206GP Pinchweld Primer must be used as needed. S1KA21530 Primer must be used in PVC and EPDM applications. Prep glass with Sika® Aktivator (see below).

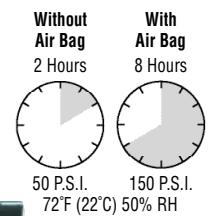

CAT. NO.	CONTENTS	QTY/CASE
S1KA220	10.5 Fl. Oz. (311 ml) Cartridge	24

Minimum order is one cartridge. All automotive sealants can be combined for quantity pricing.

CRL Sika® Primer-206 G+P Pinchweld Primer

- For Use with Sika® Urethane Adhesives

A one-component, fast drying, moisture sensitive black liquid used to cover all bare metal prior to bonding with Sika® Urethane Adhesives. Apply to pinchweld with Cat. No. 1AB Disposable Brush, or Cat. No. 1CS Cotton Swabs with Wooden Shafts.



CAT. NO.	CONTENTS	QTY/CASE
S1KA206GP	8.3 Fl. Oz. (250 ml)	6

CRL Sika® Aktivator

- Fast Drying Glass Prep for Use with Sika® Urethane Adhesives

CRL Sika® Aktivator is a moisture sensitive liquid that must be used to pre-treat glass prior to application of Sika® Adhesives. One-component formula enhances the adhesive bond, is fast drying, and applies easily with wool daubers, such as Cat. No. PT1U409.



CAT. NO.	CONTENTS	QTY/CASE
60D960	8.3 Fl. Oz. (250 ml)	6

CRL Sika® Primer-206 Pinchweld Primer Stix

- For Use with Sika® Urethane Adhesives
- Built-In Applicator

Sika®Primer-206 Stix are used for pinchweld treatment of all fresh scratches or bright metal rubs and scrapes prior to bonding with Sika®Urethane Adhesives. Unique packaging provides primer and applicator all in one! Contains 16 individual 1.4 ml applicators per box.

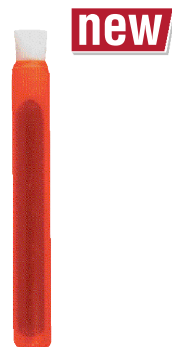

new

CAT. NO.	CONTENTS	PACKAGING
S1KA060	.01 Fl. Oz. (1.4 ml)	16 Stix



CRL Sika® Aktivator Pads

new

- For Use with Sika® Urethane Adhesives
- Fast Drying Single Use Size Means Less Waste



Our new Sika®Aktivator Pads are the easiest and neatest way to apply Sika® Aktivator to glass. They resemble a small paint pad. A quick squeeze of the handle dispenses the Aktivator solution into the drip-free pad, evenly applying it to the targeted surface to clean and prepare the glass for Sika® Urethane Adhesives. Available in packages of five, or cartons of 17, the recommended number of pads for one case of Sika® Urethanes.

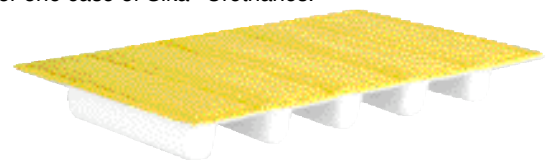

Five Pads



CAT. NO.	CONTENTS	PACKAGING
6H12SPK	.37 Fl. Oz. (11 ml)	5 Pads/Pack
6H12S	.37 Fl. Oz. (11 ml)	17 Pads/Ctn.

CRL Sika® Primer-215

- For use with Rigid and Semi-Rigid PVC and EPDM Encapsulated Parts

New encapsulated parts require new primers for OEM bonding strength when urethane is being bonded to the encapsulation rather than to the glass. PVC and EPDM encapsulated parts can not be bonded to the body using normal primers. Select this primer for a sure bond in these cases.



CAT. NO.	CONTENTS	QTY/CASE
S1KA21530	1 Fl. Oz. (30 ml)	6



CRL Titan™ T2000HV Fast Curing Urethane Adhesive

Refer to Pages A105-A108 for Complete Tech Chart

- Primerless to Glass and Frit
- High Viscosity Formula
- Rates Non-Conductive, High Modulus

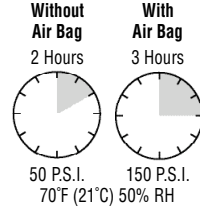

CAT. NO.	CONTENTS	QTY/CASE
T2000HV	10.5 Fl. Oz. (311 ml) Cartridge	12

Minimum order is 12 cartridges. Must be ordered in increments of 12. All automotive sealants can be combined for quantity pricing.

CRL T2000HV is a high viscosity, fast curing, one-part urethane adhesive designed to support auto glass without the use of dam tape. T2000HV meets or exceeds U.S. FMVSS 208, 212 and 216. To ensure manufacturer's standards are met, GP60 Glass Cleaner and W1P40 Pinchweld Primer must be used as directed.

CRL Titan™ T1000 Fast Cure Urethane Adhesive

- Primerless to Glass and Frit
- Quick Strength Buildup, Even in Colder Temperatures
- Non-Conductive, High Modulus

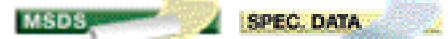
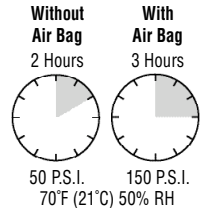

CAT. NO.	CONTENTS	QTY/CASE
T1000	10.5 Fl. Oz. (311 ml) Cartridge	12

Minimum order is 12 cartridges. Must be ordered in increments of 12. All automotive sealants can be combined for quantity pricing.

T1000 has the quickest strength buildup of any one-part Titan Urethane available. Its unique balance of tensile, shear and elongation strength provides excellent buildup, even in colder temperatures. Meets or exceeds U.S. FMVSS 208, 212 and 216. In order to meet manufacturer's standards, GP60 Glass Cleaner and W1P40 Pinchweld Primer must be used as directed.

CRL Titan™ T660 High Modulus Urethane Adhesive

- Primerless to Glass and Frit
- High Modulus, Fast Cure Formula
- No Dam Tape Required

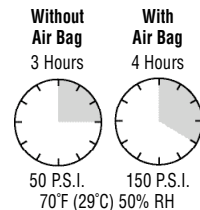

CAT. NO.	CONTENTS	QTY/CASE
T660	10.5 Fl. Oz. (311 ml) Cartridge	12

Minimum order is 12 cartridges. Must be ordered in increments of 12. All automotive sealants can be combined for quantity pricing.

T660 is a high viscosity, one-part urethane adhesive developed to be used without the aid of dam tape. The heavy body formula is sag resistant, and maintains any bead shape. It delivers fast curing, high psi strength, and excellent adhesion to urethane, metal and glass. Meets or exceeds U.S. FMVSS 208, 212 and 216. In order to meet manufacturer's standards you must use GP60 Glass Cleaner and W1P40 Pinchweld Primer as directed.

CRL GP60 Glass Cleaner

- For Use with All Titan Adhesives
- Also Acts as a EPDM and PVC Primer for Titan Adhesives

One-part, fast drying glass conditioner for enhanced bond to glass and ceramic frit. Cleans and conditions the surface prior to the application of Titan Adhesives.



CAT. NO.	CONTENTS	QTY/CASE
GP60	6 Fl. Oz. (177 ml)	6



CRL W1P40 Pinchweld Primer

- For Use with All Titan Adhesives

A one-part, fast drying primer for improving adhesion of Titan Adhesives to metal surfaces. Use to touch up bare metal scratches, or for preparing areas that have been repaired and repainted.



CAT. NO.	CONTENTS	QTY/CASE
W1P40	6 Fl. Oz. (177 ml)	6



CRL Titan™ T380 Quick Curing Urethane Adhesive

Refer to Pages A105-A108 for Complete Tech Chart.

- Primerless to Glass and Frit
- High Modulus
- Easy Gunning

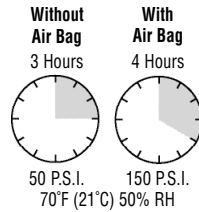

CAT. NO.	CONTENTS	QTY/CASE
T380	10.5 Fl. Oz. (311 ml) Cartridge	12

Minimum order is 12 cartridges. Must be ordered in increments of 12. All automotive sealants can be combined for quantity pricing.

CRL Titan™ T380 provides a safe, strong bond, and is designed for windshield and backlite installations. It is easy to gun without sagging, and can be water tested immediately. Meets or exceeds U.S. FMVSS 208, 212, and 216. In order to ensure the manufacturer's standards are met, W1P40 Pinchweld Primer must be used as directed.

CRL Titan™ T800EM High Viscosity Urethane Adhesive

new

- Carlite Approved
- High Modulus and High Decking
- OEM Proven Confidence

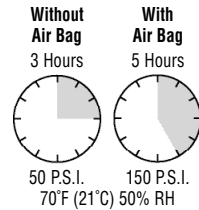

CAT. NO.	CONTENTS	QTY/CASE
T800EM	10.5 Fl. Oz. (311 ml) Cartridge	12

Minimum order is 12 cartridges. Must be ordered in increments of 12. All automotive sealants can be combined for quantity pricing.

CRL Titan™ T800EM Urethane Adhesive is formulated for excellent adhesion to provide for safer auto glass installations. This high performance adhesive provides you with exceptional high decking, which will support the glass without dams or blocks. Performance characteristics meet or exceed all one-component original equipment specifications, including U.S. FMVSS 208, 212, and 216, as well as Carlite approval, giving you a user-friendly installation with OEM proven confidence.

CRL Disposable Nitrile Gloves

- Provide Resistance Against Solvents and Other Chemicals
- Powder-Free



CRL Nitrile Gloves are made of 100% nitrile, which is resistant to a broad range of chemicals, and provides better protection against solvents than latex. Good for use when splash protection is required. The nitrile compound also gives greater puncture resistance than comparable natural rubber and vinyl disposable gloves. They also reduce hand pressure and fatigue caused by elastomeric stress (that means they feel good on your hands). CRL Nitrile Gloves are medical grade (no holes, better than industrial grade), and are also powderless (no contaminants). Packed 100 each to a dispenser-type box.

CAT. NO.	QTY/BOX
7005NG	100 Gloves

CRL Mirror Hang Tags

- Provides Critical Information for Vehicle Owner
- The Professional Finish Touch

CRL Mirror Hang Tags give your windshield replacement customer important information related to their new windshield. Proper care after the installation prevents call backs for leaks and dissatisfied customers. This inexpensive product produces good customer relations and shows you care, even after your customer drives off.

One side of the tag cautions the customer on ways to prevent problems associated with the replacement, while the other side offers your customer information on CRL Truck Sliders and Glass Cleaners you can provide.

CAT. NO.	QTY/PACK
AVD6243PK	24 Tags



CRL Essex™ U418HV Quick Cure Primerless High Viscosity Urethane Adhesive

Refer to Pages A105-A108 for Complete Tech Chart.

new

- Meets All OEM Standards
- Fast Installations – No Windshield Prep or Glass Primer Needed



CRL Essex™ U418HV Adhesive eliminates steps and speeds installations by incorporating the glass primer into the urethane adhesive. U418HV meets all OEM standards, and is available in this high viscosity formula that is preferred by many installers because it eliminates the need for dam tape, and has higher initial (green) strength. U418HV requires Cat. No. U5404 Betaprime Primer on the pinchweld if the metal is scratched during glass removal.



CAT. NO.	DESCRIPTION	CONTENTS	QTY/CASE
U418HV	High Viscosity Urethane	10.5 Fl. Oz. (310 ml)	10

All automotive sealants can be combined for quantity pricing.

CRL Essex™ U418 Quick Cure Primerless Regular Viscosity Urethane Adhesive

new

- Meets All OEM Standards
- Fast Installations – No Windshield Prep or Glass Primer Needed



Our Essex™ U418 Quick Cure Regular Viscosity Urethane Adhesive meets all OEM standards. It eliminates steps and speeds installations by incorporating the glass primer into the urethane adhesive. It does require you use Cat. No. U5404 Betaprime Primer on the pinchweld if the metal is scratched during glass removal.



CAT. NO.	DESCRIPTION	CONTENTS	QTY/CASE
U418	Regular Viscosity Urethane	10.5 Fl. Oz. (310 ml)	10

All automotive sealants can be combined for quantity pricing.

CRL Essex™ U400HV Rapid Cure High Viscosity Urethane Adhesive

new

- OEM Tested, Approved and Used
- Rapid Cure Performance
- High Viscosity (HV) Formulation



Many OEMs use CRL Essex™ U400HV Rapid Cure Urethane Adhesive to install auto glass in new vehicles. They also recommend it for aftermarket replacements. Essex™ U400HV meets FMVSS 212 Windshield Retention and FMVSS 216 Roof Crush Standards. The high viscosity formulation eliminates the need for dam tape, and has higher initial (green) strength. Prepare the windshield with Cat. No. U5500 Betaprime Glass Primer; prime the pinchweld with Cat. No. U5404 Betaprime Pinchweld Primer on the pinchweld if the metal was scratched during glass removal.



CAT. NO.	DESCRIPTION	CONTENTS	QTY/CASE
U400HV	High Viscosity Urethane	10.5 Fl. Oz. (310 ml)	10

All automotive sealants can be combined for quantity pricing.



LOG ON TO crlaurence.com FOR BUSINESS-TO-BUSINESS SERVICES

A120 | PHONE (800) 421-6144 | FAX (800) 262-3299 TOLL FREE FROM ANYWHERE IN THE U.S.A. OR CANADA

CRL Essex™ U208HV Betaseal™ Express Advanced Cure Urethane Adhesive

new

- Safe Drive Away in One Hour and Passes FMVSS 212 Crash Test at Temperatures as Low as 0° (-17.8°C)
- Meets All OEM Requirements, Including Long Term Durability
- Excellent for Cold Weather Installations



Refer to Pages A105-A108 for Complete Tech Chart.



CRL Essex™ U208HV Betaseal™ Express Advanced Cure Urethane Adhesive delivers fast drive away times at low cost. This advanced cure polyurethane adhesive provides safe drive away in one hour at temperatures as low as 0° F (-17.8° C) and warmer. Essex™ Betaseal™ Express meets all OEM requirements, including long-term durability. Prepare the windshield with Cat. No. U5500 Betaprime Glass Primer. Use Cat. No. U5404 Betaprime Pinchweld Primer on the pinchweld if the metal was scratched during glass removal.

CAT. NO	CONTENTS	QTY/CASE
U208HV	10.5 Fl. Oz. (310 ml)	10

All automotive sealants can be combined for quantity pricing.



CRL Essex™ Betaprime U5404 Urethane Pinchweld and Encapsulation Primer

new

- One Primer for Pinchweld, PAAS, RIM, and PVC
- Reduces Need to Carry Multiple Primers
- Compatible with All Essex™ Urethane Adhesives

Apply Betaprime U5404 to small areas of bare metal scratches or unpainted areas on cleaned pinchweld to promote adhesion. Also reactivates the pre-applied adhesive system (PAAS) bead found on windshields installed on several vehicle models manufactured by BMW, Volkswagen, Saab, Porsche, Fiat, and others. Promotes adhesion between Essex™ Urethane Adhesives and OEM PVC (polyvinyl chloride) substrates, and bonds to RIM (reaction injection molding) encapsulation.



CAT. NO.	CONTENTS	QTY/CASE
U5404	3.4 Fl. Oz. (100 ml)	5



CRL Essex™ Betaprime U5500 One-Step Glass/Frit Primer

new

- Preps and Primes Windshield in One Pass
- Meets All OEM Requirements

Use Essex™ U5500 with all Essex™ Urethane Adhesives that require auto glass primers. The black color provides protection against ultraviolet rays. Easy to use and meets all OEM requirements, including long-term durability.



CAT. NO.	CONTENTS	QTY/CASE
U5500	3.4 Fl. Oz. (100 ml)	5



CRL Essex™ Betaprime U5201 Bare Metal Etch Primer

new

- One-Part Bare Metal Etch Primer
- Dries in 30 Minutes

Essex™ Betaprime primes bare metal in one quick, easy step. U5201 etches the exact degree of roughness necessary to prepare the metal for proper bonding. It cures approximately 50 times faster than conventional two-part mixes, and may be used with all CRL Essex™ Urethane Adhesives. Must be used on bare metal areas larger than 1/2" (12 mm) square.



CAT. NO.	CONTENTS	QTY/CASE
U5201	.5 Fl. Oz. (15 ml)	5



CRL 3M™ Windo-Weld™ Super Fast Urethane

- 15 Minute Tack Free Time
- Fast Cure
- Exceeds OEM Strength Requirements
- Officially Licensed by NASCAR™



3M™ Super Fast Urethane is a fast curing windshield adhesive with high green strength. It meets FMVSS 212 strength requirements in as little as four hours, depending upon temperature and humidity. 3M™ Super Fast Urethane is a one-component polyurethane-based adhesive formulated for bonding automotive glass. It will develop up to 1,200 psi in tensile strength at full cure to provide your customer with a safe installation.

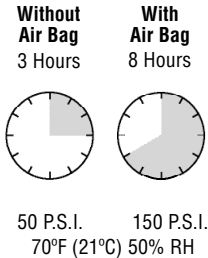

CAT. NO.	CONTENTS	QTY/CASE
3M8609	10.5 Fl. Oz. (310 ml)	12

All automotive sealants can be combined for quantity pricing.

CRL 3M™ Fast Cure Auto Glass Urethane (High Viscosity)

- Passed FMVSS 212 @ Four Hours
- Meets OEM Strength Requirements
- Carlite™ by Visteon™ Approved
- Officially Licensed by NASCAR™

new



3M™ Fast Cure is a one-part, moisture curing urethane providing rapid strength build-up. This high strength, high viscosity adhesive is designed for use in full cut-out installations without dam tape. Passes FMVSS 212 at four hours at 70°F / 50% RH with dual airbags.

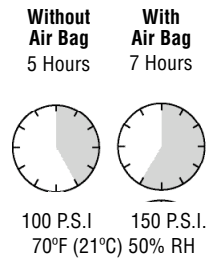

CAT. NO.	CONTENTS	QTY/CASE
3M8690	10.5 Fl. Oz. (310 ml)	12

All automotive sealants can be combined for quantity pricing.

CRL 3M™ Auto Glass Urethane Windshield Adhesive (Medium Viscosity)

- Passes FMVSS 212 and 216, and Meets OEM Strength Requirements
- Fast Cure

new



CRL 3M™ Auto Glass Urethane Windshield Adhesive is a one-part, moisture curing, medium viscosity product that provides a fast cure with the high strength required for the reinstallation of vehicle windshields, backglass, and sidelites.

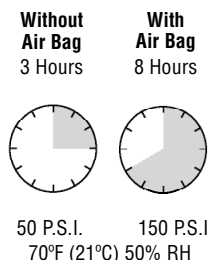

CAT. NO.	CONTENTS	QTY/CASE
3M8693	10.5 Fl. Oz. (310 ml)	12

All automotive sealants can be combined for quantity pricing.



CRL 3M™ Auto Glass Urethane Windshield Adhesive (High Viscosity)

new

- Meets FMVSS 212 and 216
- Exceeds OEM Strength Requirements
- Fast Cure

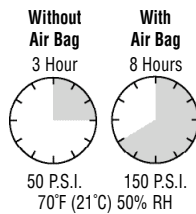

CRL 3M™ High Viscosity Auto Glass Windshield Urethane is a one-part, moisture curing urethane. Its fast cure formulation provides the high strength required for the reinstallation of vehicle windshields, backglass, and sidelites.

CAT. NO.	CONTENTS	QTY/CASE
3M8696	10.5 Fl. Oz. (310 ml)	12

All automotive sealants can be combined for quantity pricing.

CRL 3M™ Single Step Primer

new

- One Primer for Both Glass and Pinchweld
- Also Promotes Adhesion to PVC Encapsulated Parts
- Does Not Need an Activator

3M™ Single Step Primer is a polyurethane-based primer that promotes adhesion of polyurethane adhesives to glass, painted pinchweld metal, and PVC encapsulated parts. It is also a black-out primer to block out the sun's ultraviolet rays.



CAT. NO.	CONTENTS	QTY/CASE
3M8681	4.2 Fl. Oz. (125 ml)	6

How Does Your Urethane Stack Up to Other Brands?

Choosing the right urethane adhesive can be a real chore if you don't have enough information to make an informed decision. There are different cure rates, viscosities, recommended drive-away times, and other factors to consider.

Our Cross Brand Tech Comparison Chart on pages A106 to A108 shows you how CRL and other brands of urethanes stack up against each other. There's a wealth of information that will aid in your buying and application decisions, leading to better overall product satisfaction.

CRL Cross Brand Tech Comparison Chart

HIGH VISCOSITY URETHANES

BRAND NAME	PASSED FMVSS	MEETS FMVSS	MINIMUM DRIVE AWAY TIME WITH AIR BAG	LAP SHEAR @ DRIVE AWAY	LAP SHEAR @ ULTIMATE CURE TIME	TENSILE STRENGTH @ 7 DAYS	URETHANE CAT. NO.	PRIMER CAT. NO.	PRIMER DESCRIPTION
CRL CRL900HV HIGH VISCOSITY	#208 #212 OEM*	#208 #212 OEM*	8 HOURS @ 72°F 50% RH	N/A	650 PSI	1200 PSI	CRL900HV Cartridge CRL915HV Sausage	CRL9GC CRL9P CRL9EP	GLASS PREP PINCHWELD EPDM/PVC
CRL POWR 300 PRIMERLESS HIGH VISCOSITY	#218 #212 #216 OEM*	#218 #212 #216 OEM*	3 HOURS @ 70°F 50%RH	150 PSI W / AIR BAGS	>550 PSI	>1000 PSI	PP301HV	PP3MP PP3UV	PINCHWELD UV BLOCKER AND EPDM/PVC
ESSEX U400HV HIGH VISCOSITY		#212 #216 OEM*	4 HOURS @ 70°F 50%RH	N/A	>500 PSI	>1000 PSI	U400HV	U5500 U5404	GLASS PREP PINCHWELD
TITAN 2000HV FAST CURING	#208 #212	#208 #212 #216	3 HOURS @ 70°F 50%RH	150 PSI W / AIR BAGS	>550 PSI	>1000 PSI	T2000HV	W1P40 GP60	PINCHWELD EPDM/PVC



CRL Butyl Autoglass Tape

- Positive Bond on Contact
- Won't Flow Out of the Pinchweld
- Unlimited Shelf Life
- No Damage to Interior Trim

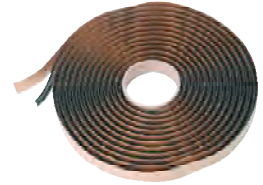

CRL Butyl Autoglass Tape has been developed for installers to meet specific needs. It is easily compressible and tacky, but won't flow out of the pinchweld. This means ease of installation with no clean up. It's the one tape that gives you the support, sealing, and strength you need for leak-proof installations and no call-backs. Controlled rebound allows proper molding fit. CRL Butyl Autoglass Tape has been proven to be one of the finest tapes on the market. That is why we can guarantee your complete satisfaction. Try it on your next installation and you'll see that you can still get quality at an economical price.

NOTE: Butyl tapes should not be used where OEM has installed the automotive glass with urethane. Please consult the OEM guidelines for your installation.

ROUND TAPE

CAT. NO.	SIZE	FEET/ROLL	ROLLS/CASE
CRL1401	1/4" (6.3 mm)	15 (4.6 m)	12
CRL1403	5/16" (7.9 mm)	15 (4.6 m)	12
CRL1405	3/8" (9.5 mm)	15 (4.6 m)	12

SQUARE TAPE

CAT. NO.	SIZE	FEET/ROLL	ROLLS/CASE
CRL1303	5/16" x 5/16" (7.9 mm x 7.9 mm)	15 (4.6 m)	12
CRL1305	3/8" x 3/8" (9.5 mm x 9.5 mm)	15 (4.6 m)	12

RECTANGULAR TAPE

CAT. NO.	SIZE	FEET/ROLL	ROLLS/CASE
CRL1309	1/8" x 1/4" (3.2 mm x 6.3 mm)	30 (9.1 m)	12
CRL1504	1/4" x 5/16" (6.3 mm x 7.9 mm)	15 (4.6 m)	12
CRL1502	1/4" x 3/8" (6.3 mm x 9.5 mm)	15 (4.6 m)	12

All sizes of Butyl Autoglass Tape can be combined for quantity pricing. Minimum order is case quantity.



CRL Pinchweld Primer for Butyl Tape

- Designed to Enhance the Adhesion of Butyl Autoglass Tape
- Quick Drying
- Easy to Apply

CRL Professional Pinchweld Primer for Butyl Tape is an adhesive primer designed for coated metal or glass. Quick drying compound goes on quickly and evenly with the built-in brush-top applicator. CRL1106 improves the adhesion of butyl tapes to metal or glass surfaces.

NOTE

Not for use with urethane set glass.

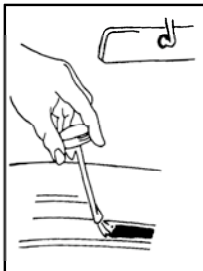

Includes Brush-Top Applicator



CAT. NO.	CONTENTS	QTY/CASE
CRL1106	16 Fl. Oz. (473 ml)	12



CRL Foam Core Butyl Tape

- Compressible PVC Foam Inner Core – High Tack 100% Solids Butyl Coating
- Particularly Suited to Vehicle Fabrication

new

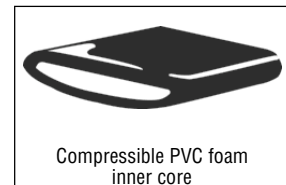

Compressible PVC foam inner core

CRL Foam Core Butyl Tape is required on quarter windows of various vehicles and back glass installations. It is also ideal for sealing joints in RVs, motor homes, trailers, and boats, places where joints are subject to the stress of movement and the effects of constant exposure to the elements. The soft inner core responds to body movement, expansion, and contraction. These versatile foam extrusions seal effectively against water penetration to prevent corrosion or moisture damage. Foam Core Butyl Tape controls sound better than standard butyl tape.

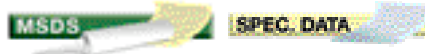

CAT. NO.	SIZE	FEET/ROLL	ROLLS/CASE
CRL1600	3/16" (4.8 mm) Round	15 (4.6 m)	24
CRL1601	1/4" (6.3 mm) Round	15 (4.6 m)	24

All sizes of Butyl Autoglass Tape can be combined for quantity pricing.



LOG ON TO crlaurence.com FOR BUSINESS-TO-BUSINESS SERVICES

CRL 3M™ Window-Weld™ Ribbon Sealer (Butyl Autoglass Tape)



3M™ Window-Weld™ Ribbon Sealer is a tape-type sealer used in the replacement of windshields and backlites on all butyl set car and truck models. It supports the glass and seals on contact. Forms a water tight seal when used with CRL1106 Butyl Tape Primer.

BULK CASES

CAT. NO.	SIZE	FEET/ROLL	ROLLS/CASE
3M8620	1/4" (6.4 mm) Round	15 (4.6 m)	24
3M8621	5/16" (7.9 mm) Round	15 (4.6 m)	24
3M8622	3/8" (9.5 mm) Round	15 (4.6 m)	24
3M8625	1/8" x 1/4" (3.2 x 6.4 mm)	30 (9.1 m)	24

All sizes of Butyl Autoglass Tape can be combined for quantity pricing. Minimum order is 24 rolls (one case).

MSDS

SPEC. DATA

INDIVIDUAL KITS

CAT. NO.	SIZE	FEET/ROLL	ROLLS/CASE
3M8611	5/16" (7.9 mm) Round	15 (4.6 m)	1
3M8612	3/8" (9.5 mm) Round	15 (4.6 m)	1

All sizes of Butyl Autoglass Tape can be combined for quantity pricing. Minimum order is one kit.

CRL 3M™ Strip-Calk Bedding and Glazing Compound

- Easily Thumbed Into Place and Smoothed with Finger
- May Be Painted Immediately
- Will Not Crack or Dry Out
- Unlimited Shelf Life

3M™ Strip-Calk Bedding and Glazing Compound is a soft, non-hardening caulking material in one foot lengths for use in all types of seams, joints, and openings. Adheres well to metal, paint, glass, and rubber. 3M™ Strip-Calk is easy to apply, and can be painted immediately. Excellent for sealing retaining clip holes for interior or exterior trim. Black color material comes 60 each one foot lengths per box, 12 boxes per case.



MSDS

SPEC. DATA

CAT. NO.	STRIP SIZE	STRIP LENGTH	STRIPS/BOX
3M8578	1/8" x 1/4" (3.2 mm x 6.4 mm)	1 Ft (30 cm)	60

Can be combined with Butyl Autoglass Tape for quantity pricing. Minimum order is one box.

CRL Loctite® Contact Adhesive (Black)

- Bonds All Types of Weatherstripping, Vinyl Tops, and Fabric
- Water and Chemical Resistant
- Fast Drying

Loctite® Contact Adhesive is a black viscous liquid contact type cement for all types of weatherstripping and general purpose bonding. Typical applications include door and trunk moldings, weatherstripping, vinyl tops, and fabric-backed vinyl upholstery.



MSDS

SPEC. DATA

CAT. NO.	CONTENTS	QTY/CASE
30540	5 Fl. Oz. (147 ml)	12

CRL Loctite® Contact Adhesive (Yellow)

- Bonds Rubber, Metal, Wood, Gasketing Materials, and Fabric-Backed Vinyl Upholstery
- Fast, High Strength Bonds
- Waterproof

Loctite® Contact Adhesive is a yellow, viscous liquid contact cement for all types of weatherstripping and general purpose bonding. Bonds weatherstripping, insulation, rubber, and trim to wood and metal.



MSDS

SPEC. DATA

CAT. NO.	CONTENTS	QTY/CASE
30537	5 Fl. Oz. (147 ml)	12

CRL Foam Windshield Support Tapes

- Reduces Wind Noise and Improves Sightline
- Supports Windshield While Urethane Cures
- Available with Single and Double Sided Adhesive in Three Heights

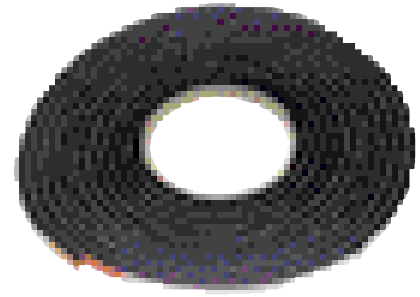
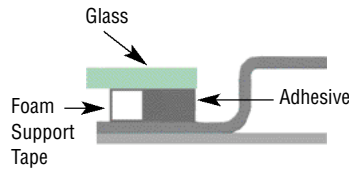

These CRL Foam Windshield Support Tapes are not only used as a support device when using medium viscosity urethanes, but are now also a required item when replacing numerous windshields that need additional sound proofing in order to keep wind noise to a minimum. Not using foam support tape can lead to customer complaints of elevated wind noise.

CRL Foam Windshield Support Tape retains most of its height to create more glass-to-urethane contact area. CRL Foam Windshield Support Tape with adhesive on one side allows you to reposition the windshield after the glass has been set in place. CRL Foam Windshield Support Tape with adhesive on two sides will increase initial adhesion strength. Its aggressive adhesive bonds to pinchweld and glass, and its high density foam bends easily, forming a smooth finish on the inside of the car. Available in three heights.

NOTE: If foam tape is found on the original installation, the OEM has installed this as an additional sound deadening device. Tape must be reinstalled or additional noise levels will be evident to the customer.

TAPE WITH ADHESIVE ON ONE SIDE

CAT. NO.	TAPE SIZE	MIN. ORDER
FC250R	1/4" x 1/4" x 16 Ft (6 mm x 6 mm x 4.9 m)	12 Rolls
FC312R	1/4" x 5/16" x 16 Ft (6 mm x 8 mm x 4.9 m)	12 Rolls
FC375R	1/4" x 3/8" x 16 Ft (6 mm x 10 mm x 4.9 m)	12 Rolls
FC250C	1/4" x 1/4" x 500* Ft (6 mm x 6 mm x 152.4 m)	1 Case
FC312C	1/4" x 5/16" x 500* Ft (6 mm x 8 mm x 152.4 m)	1 Case
FC375C	1/4" x 3/8" x 500* Ft (6 mm x 10 mm x 152.4 m)	1 Case

Rolls can be combined for quantity pricing.
*50 foot (15.2 meter) rolls packed ten per case.

TAPE WITH ADHESIVE ON TWO SIDES

CAT. NO.	TAPE SIZE	MIN. ORDER
FD250R	1/4" x 1/4" x 16 Ft (6 mm x 6 mm x 4.9 m)	12 Rolls
FD312R	1/4" x 5/16" x 16 Ft (6 mm x 8 mm x 4.9 m)	12 Rolls
FD375R	1/4" x 3/8" x 16 Ft (6 mm x 10 mm x 4.9 m)	12 Rolls

Rolls can be combined for quantity pricing.

CRL Foam Windshield Support Blocks

- Helps Retain Position of Glass While Adhesive Cures
- Self-Adhesive Pre-Cut Pads of Blocks are Simple to Use
- Available in Three Heights

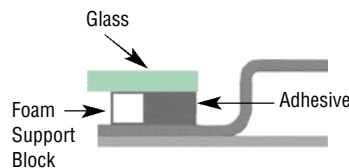

Easy to Handle
Pre-Cut Pads

CRL Foam Windshield Support Blocks are designed to prevent the windshield from sinking before the urethane cures, which may happen even with high viscosity urethanes. Blocks are made of high density foam that effectively supports the glass. Available in pre-cut pads in three heights with adhesive on one side to keep blocks in place during installation.

MONEY-SAVING FULL CASES

CAT. NO.	BLOCK SIZE	BLOCKS/PAD	BLOCKS/CASE
FB250C	1/4" x 5/16" x 1" (6 mm x 8 mm x 25.4 mm)	72	7200
FB312C	1/4" x 1/4" x 1" (6 mm x 6 mm x 25.4 mm)	72	7200
FB375C	1/4" x 3/8" x 1" (6 mm x 10 mm x 25.4 mm)	72	7200

Full cases can be combined for quantity pricing. Minimum order is one case.

BLOCKS IN POLY-PACKS

CAT. NO.	BLOCK SIZE	BLOCKS/PAD	BLOCKS/PACK
FB250P	1/4" x 5/16" x 1" (6 mm x 8 mm x 25.4 mm)	72	720
FB312P	1/4" x 1/4" x 1" (6 mm x 6 mm x 25.4 mm)	72	720
FB375P	1/4" x 3/8" x 1" (6 mm x 10 mm x 25.4 mm)	72	720

Poly-Packs can be combined for quantity pricing. Minimum order is one pack.



CRL Windshield Sealant

- Can Be Water Tested Immediately
- Cures to a Butyl Tape Consistency
- Applies Easily and Quickly

CRL Windshield Sealant is a one-part, ready-to-use sealant for resealing windshields and backlites. Also useful for sealing drip rails and pinchwelds after installation of vinyl hardtops. Cures to a tough, flexible, rubbery bead with powerful adhesion to glass, butyl tape, and all metal surfaces.

CAT. NO.	COLOR	CONTENTS	QTY/CASE
CRL7711	Black	11 Fl. Oz. (326 ml)	10

All automotive sealants can be combined for quantity pricing.

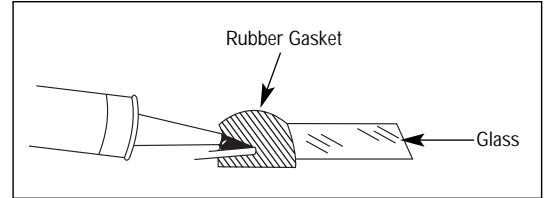

CRL Windshield and Body Sealant

- Non-Curing Flow Grade Butyl in Cartridges
- Remains Tacky Throughout Life, Does Not Skin Over
- Can Be Water Tested Immediately

CRL Windshield and Body Sealant is an economical, non-hardening, water resistant sealing product formulated for use as a sealant and bedding compound for windshields installed in rubber gaskets. It locks out moisture, dust, and cold air instantly. CRL7708 remains flexible and resilient, and can also be used to seal weatherstripping and concealed body joints.

CAT. NO.	COLOR	CONTENTS	QTY/CASE
CRL7708	Black	11 Fl. Oz. (326 ml)	10

All automotive sealants can be combined for quantity pricing.

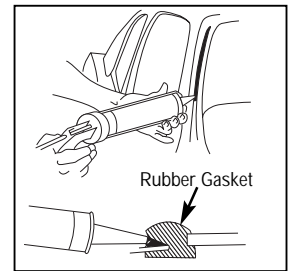

CRL Windshield and Repair Sealant

- Flow Grade Butyl Sealant Used to Fix Leaks in Both Gasket and Gasketless Installations
- Adheres Well to Glass and Metal
- Can Be Used with Any Standard Adhesive Gun

CRL Professional Windshield and Repair Sealant is a flow grade liquid rubber polymer compound for auto glass installations and repair work. It remains elastic, adheres well to glass, metal, and rubber surfaces, and sets up as a permanent, flexible sealant. Apply with a 716AG or 181AG Screw-on Adhesive Gun (see page A146), or with a 1AB Brush to fill any openings, such as around clips in corners, or around setting blocks and backfilling operations on new gaskets.

CAT. NO.	COLOR	CONTENTS	QTY/CASE
CRL1716	Black	16 Fl. Oz. (473 ml)	12

All automotive sealants can be combined for quantity pricing.

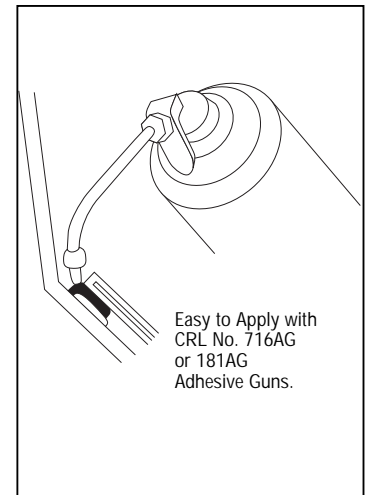

How To Use Flow Grade Butyl

Use CRL's Flow Grade Butyl to ensure your gasket set glass does not leak. Even when using a new gasket, it is always a good idea to backfill sealant around the glass side of the gasket prior to installing the gasket to the glass. After the glass has been installed, use a CRL216 Windshield Stick to lift the lip of the gasket off the body of the vehicle and gun a small bead of 1/16" to 1/8" (1.6 to 3.2 mm) onto the body a 1/4" (6.4 mm) back from the edge of the gasket with an 181AG Adhesive Gun. This needs to only be done across the top and down the sides. You will have a leak free installation following these guidelines.

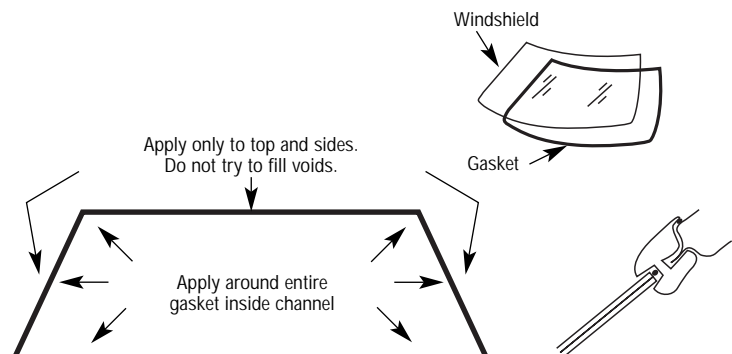

CRL 3M™ Automotive Bedding and Glazing Compound

- Non-Sagging Consistency for Vertical and Overhead Applications
- Remains Permanently Soft
- Used to Fix Leaks in Both Gasket and Gasketless Installations

3M™ Automotive Bedding and Glazing Compound is a non-hardening, pliable, water resistant, medium bodied sealer for sealing auto body seams, and between windshield gasket rubber and the vehicle body. Can also be used to seal around moldings, and to attach door water shields. It remains permanently soft and pliable to absorb body movement. Use it to fill openings around clips or in corners, around setting blocks, and in backfilling operations on new gaskets. Easy dry rag clean up.



CAT. NO.	CONTENTS	QTY/CASE
3M8509	10 Fl. Oz. (295 ml)	12

All automotive sealants can be combined for quantity pricing.

CRL 3M™ Windo-Weld™ Resealant

- Fast Drying, Remains Flexible
- Adheres to Glass and Metal
- Water-Resistant

3M™ Windo-Weld™ Resealant stops leaks in automotive “gasketless” windshields and backlites due to faulty installation of synthetic rubber adhesive sealants. Its fast drying formula flows into pinholes and crevices, around retainer clips, and spacer blocks. Windo-Weld™ adheres to glass, painted metal, and synthetic rubber sealants. For use as a supplementary sealant only. Not to be used for setting glass.



CAT. NO.	COLOR	CONTENTS	QTY/CASE
3M8634	Black	10.5 Fl. Oz. (310 ml)	12

All automotive sealants can be combined for quantity pricing.

CRL 3M™ Windo-Weld™ Resealant Flow Grade Butyl Sealant

- Used to Fix Leaks in Both Gasket and Gasketless Installations
- Adheres Well to Glass and Metal

3M™ Windo-Weld™ Resealant is a flow grade liquid rubber polymer compound for auto glass installations and repair work. It remains elastic, adheres well to glass, metal, and rubber surfaces, and sets up as a permanent, flexible sealant. Apply with 3M8994 Screw-on Adhesive Applicator (see page A146), or by 1AB Brush to fill any openings, such as around clips in corners, or around setting blocks and backfilling operations on new gaskets.



CAT. NO.	COLOR	CONTENTS	QTY/CASE
3M8633	Black	16 Fl. Oz. (473 ml)	12

All automotive sealants can be combined for quantity pricing.



LOG ON TO crlaurence.com FOR BUSINESS-TO-BUSINESS SERVICES

A128 | PHONE (800) 421-6144 | FAX (800) 262-3299 TOLL FREE FROM ANYWHERE IN THE U.S.A. OR CANADA

CRL 44NC Neutral Cure Automotive Silicone Sealant

- Low Odor, Non-Acetic Cure Formula
- Non-Corrosive
- Sets Up Fast
- Seals Van Windows, Sunroofs, Roof Vents



CRL 44NC Neutral Cure Automotive Silicone is a fast curing, neutral cure silicone with special adhesion additives for use in vehicles to seal and weatherproof. It stops leaks while cushioning the glass against shock and vibration. Easy to dispense, this one-part formula features primerless adhesion to: aluminum, stainless steel, chromium, tin, iron, plastics, silicone gaskets, rigid PVC, phenolic resin, glass, ceramic and most reflective-coated glasses.

Non-acetic formula does not cause corrosion in contact with metal, making it perfect for installations of sunroofs to sheet metal roofs. Vinyl top installers know that it is the best silicone to use for vinyl and simulated convertible top installations because the curing process does not emit gases that will bubble the top. Its fast cure time and easy tooling make it ideal for many in-house production applications as well. 44NC Silicone Sealant will stay flexible for at least 20 years, when properly applied and used under normal conditions.

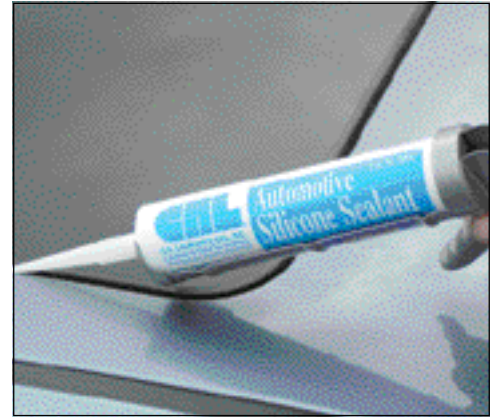

CAT. NO.	COLOR	CONTENTS	QTY/CASE
44NC	Black	10.3 Fl. Oz. (305 ml)	30



All automotive sealants can be combined for quantity pricing.

CRL Silicone Sealant in 3 Ounce Squeeze Tubes

- Our Four Most Popular Colors: Clear, Aluminum, Black, and White
- Same Great Formula as Our 33S Silicone Sealant

Professional quality CRL Silicone Sealant is available in handy 3 ounce tubes for small jobs or over-the-counter retail sales. It meets the same exacting standards and specifications as our 33S Silicone, so it is a proven product you can use or sell with complete confidence.

We have a retail display featuring all four colors (48 tubes in all) in the handy 3 ounce size on a colorful display rack. Ask for Cat. No. POP10. For more details, go to crlaurence.com.

CAT. NO.	COLOR	CONTENTS	QTY/CASE
22C	Clear	3 Fl. Oz. (90 ml)	12
22AL	Aluminum	3 Fl. Oz. (90 ml)	12
22BL	Black	3 Fl. Oz. (90 ml)	12
22W	White	3 Fl. Oz. (90 ml)	12

Colors can be combined for quantity pricing.



CRL Red RTV High-Temp Silicone Gasket

- Temperature Operating Range: Continuous Exposure to 450°F (222°C), Intermittent Exposure to 500°F (260°C)
- Makes In-Place Seals for Many Automotive Uses
- Packaged with Screw-On Nozzle for Retail Sales

Easy to apply, CRL Red RTV High-Temp Silicone Gasket lets you make any size or shape gasket or seal in minutes. This acetic cure silicone's special formula resists the effects of heat, regular and synthetic oils, grease, anti-freeze, and transmission fluid. CRL 55RED bonds, waterproofs and insulates most materials. Replaces most cork, asbestos, felt, rubber, paper, or metal gaskets in minutes. Bonds to metal, plastics, glass, vinyl, rubber, leather, fabrics, wood, tile, and ceramic. Low volatility formula makes it acceptable for OEM requirements for safe usage on automotive oxygen sensing devices.



CAT. NO.	COLOR	CONTENTS	QTY/CASE
55RED	Red	3 Fl. Oz. (90 ml)	12



CRL Small Tube Dispenser Handle

- Makes Small Tubes of Sealant or Caulking Easy to Dispense



CAT. NO. 710XX006

The fast and easy way to dispense materials (such as silicones and adhesives) from squeeze tubes. It lets you apply just the right amount of pressure for the proper bead size, and since you apply just the right amount of material, there is less mess and clean up. The open back design lets you draw the tube through the handle, so you can get virtually all of the material from the tube, so waste is reduced. Holds all flexible plastic or metal tubes up to 2-1/2" (6.35 cm) wide.

CRL AUTOMOTIVE SEALANTS

For Pricing on CRL Products, Call Toll Free (800) 421-6144, or Visit crlaurence.com

CRL RTV408 Non - Acetic Cure Silicone

- Low Odor, Non-Acetic Cure Formula is Suitable for Vehicle Bodies
- Available in Eight Colors
- Excellent Adhesion to Most Surfaces
- Easy Gunnability and Tooling
- 20 Year Limited Warranty

CRL RTV408 Silicone is a neutral cure, medium modulus, 100% silicone sealant that cures to a tough, flexible rubber when exposed to moisture. It is an excellent silicone for use on vehicle surfaces, such as sealing under the frames of sunroofs, van and RV windows, or sealing around the doors and windows of travel trailers and motor homes, because its non-acetic formulation will not attack paint or promote corrosion. CRL RTV408 features primerless adhesion to: aluminum, stainless steel, chromium, tin, iron, plastics, rigid PVC, phenolic resin, glass, ceramic and most reflective-coated glasses. Its fast cure time and easy tooling make it ideal for many in-house production applications. It is non-corrosive to most building materials. Cured RTV408 silicone remains flexible from -65°F to 400°F (-62° to 204°C) without cracking or becoming brittle. Plastic cartridges provide for a 24 month shelf life.

10.3 Fluid Ounces (305 Milliliters);
30 Cartridges Per Case;
1440 Per Pallet



CARTRIDGES

CAT. NO.	COLOR
RTV408C	Clear
RTV408AL	Aluminum
RTV408BL	Black
RTV408BRZ	Bronze
RTV408BGE	Beige
RTV408DT	Dark Tan
RTV408T	*Tan
RTV408W	*White

All cartridge sealants can be combined for quantity pricing.
*Mildew Resistant Color

RTV408 meets or exceeds these

Federal Specifications:

- TT-S-001543A (COM-NBS) Class A, for Silicone Building Sealants
- TT-S-00230C (COM-NBS) Class A, Non-Sag for One-Component Sealants
- ASTM C-920 Standard Specification for Elastomeric Joint Sealants as Type S, Grade NS, Class 25, Use NT, G, A and O
- CGSB 19.13 (Canadian Government Specification Board)
- AAMA 802.3-92 Type 1, 802.3-92 Type 2, 805.2-94 and 808.3-92



4.5 Gallon Pail (17 Liters)



48 Gallon Pail (181.7 Liters)

PAILS AND DRUMS

CAT. NO.	COLOR	CONTENTS
RTV408C5GL	Clear	4.5 Gallons
RTV408AL5GL	Aluminum	4.5 Gallons
RTV408BL5GL	Black	4.5 Gallons
RTV408BRZ5GL	Bronze	4.5 Gallons
RTV408BGE5GL	Beige	4.5 Gallons
RTV408T5GL	* Tan	4.5 Gallons
RTV408W5GL	* White	4.5 Gallons

4.5 gallon pails can be combined for quantity pricing.
*Mildew Resistant Color

CAT. NO.	COLOR	CONTENTS
RTV408C48GL	Clear	48 Gallons
RTV408AL48GL	Aluminum	48 Gallons
RTV408BL48GL	Black	48 Gallons
RTV408BRZ48GL	Bronze	48 Gallons
RTV408BGE48GL	Beige	48 Gallons
RTV408T48GL	* Tan	48 Gallons
RTV408W48GL	* White	48 Gallons

*Mildew Resistant Color

RTV408 and 95C Custom Color Silicones • Minimum Order is Only 25 Gallons

CRL can now match RTV408 and 95C Silicones to your custom color sample for those very special sealant jobs. Minimum order is only 25 gallons (94.7 liters) or more in the packaging that works best for you: 10.3 fluid ounce (305 ml) cartridges; five gallon pails [net 4.5 gallons (17 liters) per pail]; 55 gallon drums [net 48 gallons (181 liters) per drum]. Contact CRL Technical Sales for details.

CRL 95C Silicone Building Sealant

- Excellent Primerless Adhesion to Most Common Construction Substrates Including Fiberglass Panels in Mobile Homes, Trailers, and RV's
- 50% Joint Width Movement
- 20 Year Limited Warranty

CRL 95C Silicone is a one part, low modulus, neutral cure formulation that cures to a durable and flexible silicone rubber building joint seal. Designed for sealing joints in fiberglass trailer, mobile home or recreational vehicle panels; sealing expansion and control joints in precast concrete panels and metal curtainwalls; non-structural glazing of glass, metal and plastic, as well as waterproofing applications, including perimeter sealing of doors and windows. CRL 95C forms a durable, flexible watertight bond with most building materials in any combination of glass, fiberglass, ceramics, plastics, stone, masonry, wood, steel, anodized and mill-finished aluminum, and painted surfaces.

CARTRIDGES

CAT. NO.	COLOR
95CBL	Black
95CDBRZ	Dark Bronze
95CGRY	Gray
95CL	Limestone
95CW	Precast White

All cartridge sealants can be combined for quantity pricing.

PAILS

CAT. NO.	COLOR	CONTENTS
95C2GLBL	Black	2 Gallons
95C2GLDBRZ	Dark Bronze	2 Gallons
95C2GLGRY	Gray	2 Gallons
95C2GLL	Limestone	2 Gallons
95C2GLW	Precast White	2 Gallons

2 gallon pails can be combined for quantity pricing.

CAT. NO.	COLOR	CONTENTS
95C5GLBL	Black	4.5 Gallons
95C5GLW	Precast White	4.5 Gallons

4.5 gallon pails can be combined for quantity pricing.



10.3 Fl.Oz. Cartridges (305 Milliliters);
30 Cartridges Per Case;
1440 Cartridges Per Pallet



2 Gallon Pail (7.5 Liters)



4.5 Gallon Pail (17 Liters)



LOG ON TO crlaurence.com FOR BUSINESS-TO-BUSINESS SERVICES

A130 | PHONE (800) 421-6144 | FAX (800) 262-3299 TOLL FREE FROM ANYWHERE IN THE U.S.A. OR CANADA

CRL 33S Silicone Sealant

- Our Most Popular Sealant is Available in Eight Colors
- Custom Colors Also Available
- 24 Month Shelf Life
- 10 Year Limited Warranty

CRL 33S Silicone is a high quality sealant that delivers the performance you demand at a competitive price. It is a one component, room temperature curing acetic cure silicone elastomer that does not require the addition of activators, stabilizers, or catalysts to achieve optimum performance. Use 33SAL Aluminum color or 33SW White color as a seam sealer for mobile homes panels. Black color 33SBL can be used to repair many rubber items, such as gaskets around vehicle windows and doors. CRL 33S is especially designed for joining and sealing most non-porous building materials, including a variety of structural materials: glass, aluminum, metal alloys, stainless steel, wood, and plastics. It has a wide operating temperature range of -80 to 400° F (-62° to 204° C), and can be applied at outdoor temperatures as low as -35 to 140° F (-37 to 60° C).

10.3 Fluid Ounces (305 Milliliters);
30 Cartridges Per Case;
1440 Per Pallet



4.5 Gallon Pail (17 Liters)



52 Gallon Drum (197 Liters)

CARTRIDGES

CAT. NO.	COLOR
33SC	Clear
33SAL	Aluminum
33SBL	Black
33SBRZ	Bronze
33ST	* Tan
33SW	* White
33STW	* Translucent White
33SMRC	* Mildew Resistant Clear

All cartridge sealants can be combined for quantity pricing.
*Mildew Resistant Color

33S meets or exceeds these Federal Specifications:

- TT-S-001543A (COM-NBS) Class A, for Silicone Building Sealants
- TT-S-00230C (COM-NBS) Class A, Non-Sag for One-Component Sealants
- ASTM C-920 Standard Specification for Elastomeric Joint Sealants as Type S, Grade NS, Class 25, Use NT, G, A
- CGSB 19.13

PAILS

CAT. NO.	COLOR	CONTENTS
33SC5GL	Clear	4.5 Gallons
33SAL5GL	Aluminum	4.5 Gallons
33SBL5GL	Black	4.5 Gallons
33SBRZ5GL	Bronze	4.5 Gallons
33SMRC5GL	* Mildew Resistant Clear	4.5 Gallons
33ST5GL	* Tan	4.5 Gallons
33STW5GL	* Translucent White	4.5 Gallons
33SW5GL	* White	4.5 Gallons

4.5 gallon pails can be combined for quantity pricing. *Mildew Resistant Color

DRUMS

CAT. NO.	COLOR	CONTENTS
33SC52GL	Clear	52 Gallons
33SAL52GL	Aluminum	52 Gallons
33SBL52GL	Black	52 Gallons
33SBRZ52GL	Bronze	52 Gallons
33SMRC52GL	* Mildew Resistant Clear	52 Gallons
33ST52GL	* Tan	52 Gallons
33STW52GL	* Translucent White	52 Gallons
33SW52GL	* White	52 Gallons

*Mildew Resistant Color



Packaging Features for CRL Silicones

- 10.3 Fl. Oz. (305 ml) Cartridges are 30 per Case; 1440 per Pallet

Packaging quantities for C.R. Laurence Cartridge Silicones match industry standards of 30 per case. 1440 cartridges per pallet reduce load shifting during freight transport because the cartons stack together tighter.

- Plastic Cartridges with Innovative Screw-On Nozzles

Our innovative Screw-On Nozzle is standard on every cartridge of CRL33S, RTV408, and 95C Silicone. It is 4" (10 cm) long and tapered so you can trim it to the right bead size for your requirements.

- "WHMIS" Safety Label Shown on Cartridges and Cartons

Each CRL Silicone Sealant cartridge and carton contains important "WHMIS" (Workplace Hazardous Material Information System) safety data. It is shown in English, French, and Spanish to comply with shipping regulations in the U.S., Canada, and Mexico.



Low Prices for Pallet Buyers of Quality CRL Silicones



If you use lots of silicone, we have a deal for you. Quality CRL Silicones are available at special discounts when you buy it by the pallet. Full pallets contain 1,440 10.3 fluid ounce (305 milliliter) cartridges (48 cases of 30), and ship F.O.B. CRL warehouses. Contact your CRL Sales Representative or CRL Technical Sales for details.

33S Custom Color Silicone

- Minimum Order is Only 50 Gallons (189 Liters)

CRL can now match 33S Silicone to your custom color sample for those very special sealant jobs. Order only 50 gallons (189 liters) or more in the packaging that works best for you: 10.3 fluid ounce (305 ml) cartridges; five gallon pails [net 4.5 gallons (17 liters) per pail]; 55 gallon drums [net 52 gallons (196 liters) per drum]. Contact your CRL Sales Representative or CRL Technical Sales for details.

CRL AUTOMOTIVE SEALANTS

For Pricing on CRL Products, Call Toll Free (800) 421-6144, or Visit crlaurence.com

CRL 877A Auto Polyurethane Adhesive/Sealant

new

- Fast Cure, One-Component, Low Solvent Formula
- Stays Permanently Flexible
- Comparable to Sika® 221, 227, and 252



SPEC. DATA

MSDS

CRL 877A is a one-component, fast cure, low solvent, permanently flexible polyurethane adhesive/sealant that has been specifically developed for use in the fabrication and repair of trailers, trucks, buses, trains, RV utility bodies, van conversions and specialty vehicles. Applications include: vehicle bodies and cab construction including panels, underbody components, roofing, front and rear spoilers, auto trim, molding in truck trailers, RV and auto body repair. CRL 877A can also be used to seal body-to-cab joints, underside joints (floor and wheel well), bonding rubber door gaskets and profiles, and sealing and covering rivets/fastener heads. CRL 877A Auto Polyurethane is paintable, sandable, remains permanently elastic, and is non-staining. It has excellent resistance to weathering and road salts.



CAT. NO.	COLOR	CONTENTS	QTY/CASE
877A	Black	11 Fl. Oz. (325 ml)	12

All automotive sealants can be combined for quantity pricing.

CRL 3M™ Windo-Weld™ Polysulfide Sealer

- Medium-Bodied Sealer for Re-Sealing
- Applies Easily and Quickly
- Useful for Sealing Drip Rails and Pinchwelds



SPEC. DATA

MSDS

3M™ Windshield Sealant is a one-part, ready-to-use polysulfide sealant for resealing windshields and backlites. It's also useful for sealing drip rails and pinchwelds after installation of vinyl hardtops. 3M8606 cures to a tough, flexible, rubbery bead with powerful adhesion to glass, butyl tape, and all metal surfaces. **NOTE:** This product is designed as a high performance supplementary sealer, and not for use as a windshield adhesive.

CAT. NO.	COLOR	CONTENTS	QTY/CASE
3M8606	Black	10.3 Fl. Oz. (305 ml)	12

All automotive sealants can be combined for quantity pricing.

CRL 3M™ Clear Auto Sealer

- Flow Grade Liquid Rubber with Numerous Auto Body Applications

SPEC. DATA

MSDS



3M™ Clear Auto Sealer is used for sealing leaks around windshields, in tail lights, reveal moldings, trunk ornaments and other small seams on the auto body. Up to 1/8" bead can be applied easily. Excellent adhesion to metal, glass, and rubber. Will not harden or become brittle.

CAT. NO.	CONTENTS	QTY/CASE
3M8551	5 Fl. Oz. (147 ml)	12

CRL 3M™ Heavy Drip-Chek Sealer

SPEC. DATA

MSDS

- Heavier Bodied Formula is Excellent for Use on Vertical Seams



3M™ Heavy Drip-Chek Sealer is a light colored, heavy based sealer especially designed for use on vertical seams. Up to 1/8" bead can be applied easily. Excellent adhesion to metal, glass, and rubber. Outstanding weather resistance.

CAT. NO.	CONTENTS	QTY/CASE
3M8531	5 Fl. Oz. (147 ml)	12



LOG ON TO crlaurence.com FOR BUSINESS-TO-BUSINESS SERVICES

A132 | PHONE (800) 421-6144 | FAX (800) 262-3299 TOLL FREE FROM ANYWHERE IN THE U.S.A. OR CANADA

CRL 3M™ Super Weatherstrip Adhesive (Black Color)

- Primarily Designed for Use on T-Tops, Moonroofs, and Sunroofs
- Withstands Extreme Temperatures



3M™ Super Weatherstrip Adhesive is a strong, flexible, rubbery adhesive that withstands vibration and extreme temperature variations. Primarily designed for use on T-Tops, Moonroofs, and Sunroofs to provide the strength and rapid setting needed to hold weatherstripping and gaskets in place. Because of its black color, clean-up is virtually eliminated because it blends in with the rubber.

CAT. NO.	CONTENTS	QTY/CASE	MSDS	SPEC. DATA
3M8008	5 Fl. Oz. (147 ml)	12		

CRL 3M™ Super Weatherstrip Adhesive (Yellow Color)

- Exceptional Bonding Strength
- Waterproof and Flexible
- Extremely Fast Drying



This 3M™ Super Weatherstrip Adhesive is primarily used for bonding and sealing weatherstripping to car trunks and doors. Easy to brush on and spread, it's also extremely fast drying. 3M™ Super Weatherstrip Adhesive resists oil, grease, and solvents. A good general purpose cement for the auto shop.

CAT. NO.	CONTENTS	QTY/CASE	MSDS	SPEC. DATA
3M8001	5 Fl. Oz. (147 ml)	12		

CRL 3M™ Weatherstrip Adhesive

- A Black, Fast Drying Adhesive That Can Be Used for Sealing Between Rubber and Glass
- Excellent Adhesion to EPDM Weatherstripping
- Remains Flexible



This 3M™ Weatherstrip Adhesive is used for bonding and sealing weatherstripping, as well as sealing between rubber and glass. The black color matches most weatherstripping. It is easy to apply, remains flexible, and is waterproof.

CAT. NO.	CONTENTS	QTY/CASE	MSDS	SPEC. DATA
3M8011	5 Fl. Oz. (147 ml)	12		

CRL 3M™ Plastic and Emblem Adhesive

- Clear Color Adhesive for Plastic Repair and Emblem Application
- Great for Taillight Lenses and Vinyl Trim Strips
- Quick Drying



3M™ Plastic and Emblem Adhesive is used for plastic repair and emblem applications. Because it is clear, strong, and quick drying it can be used for both interior and exterior bonding.

CAT. NO.	CONTENTS	QTY/CASE	MSDS	SPEC. DATA
3M8061	5 Fl. Oz. (147 ml)	12		

CRL 3M™ Fast Tack Trim Adhesive

- Fast Drying with Long Tack
- Transparent and Non-Staining
- Permits Repositioning

3M™ Fast Tack Trim Adhesive is a transparent, extremely fast drying, non-staining adhesive with long tack for attaching various auto trim such as upholstery cloth, floor mats, carpeting, kick pads, and silencer pads to painted, primed or bare metal, wood, K.B. board or other fabrics. **NOTE:** For attaching vinyl trim, we suggest you use 3M™ Super Trim Adhesive Spray, Cat. No. 3M8090 (see page A139).



CAT. NO.	CONTENTS	QTY/CASE	MSDS	SPEC. DATA
3M8031	5 Fl. Oz. (147 ml)	12		

CRL Duramix™ Urethane Adhesives

3 to 5 Minute Formula

- For Reveal or Side Moldings
- Can be Sanded and Painted



3 to 5 Minute Two-Part Urethane Adhesive is primarily designed to make quick repairs on glue-in reveal moldings, or to glue-on side moldings or emblems in a short time span. It can also be used for repairing plastic bumpers or ground effects kits since after it cures it can be sanded and painted. No primer is required.

CAT. NO.	CONTENTS	QTY/BOX
3M4030	6 Fl. Oz. (180 ml)	6

10 Minute Formula

- For Bonding Glass to Window Channel
- No Primer Required



This channel bonding glue, unlike epoxy bonding systems, achieves a flexible adhesive strength in only ten minutes. However, it does require a minimum bonding line of 3/32" to achieve results. Therefore, when bonding channels, remove some of the hardened adhesive to allow enough thickness for proper bonding. No primer is required.

CAT. NO.	CONTENTS	QTY/BOX
3M4150	6 Fl. Oz. (180 ml)	6

30 Minute Formula

- For Universal Application of Accessories and Emblems

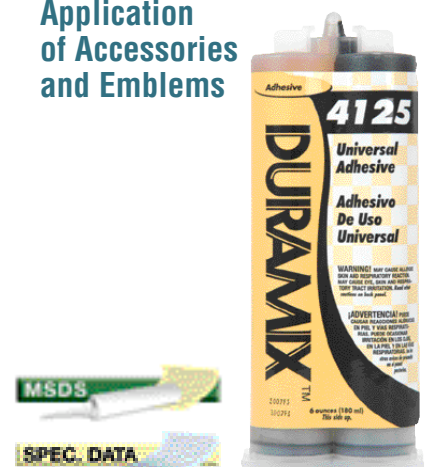

Bonds light add-on and ground effects parts such as spoilers, flares, skirts, nameplates, side moldings, emblems, and impact strips where a flexible adhesive is needed. Bonds to fiberglass and SMC, urethane, plastics and metals.

CAT. NO.	CONTENTS	QTY/BOX
3M4125	6 Fl. Oz. (180 ml)	6

Duramix™ Cure Time Information

- WORKING TIME:** The amount of time you have to work with the material before it starts to set.
- CURE TIME:** The amount of time it takes for the material to cure so it is functional.
- FULL CURE TIME:** The amount of time it takes to achieve full bonding strength.

CAT. NO.	WORKING TIME	CURE TIME	FULL CURE TIME
3M4030	50 Seconds	3 to 5 Minutes	1 Hour
3M4150	3 Minutes	10 Minutes	2 Hours
3M4125	10 Minutes	30 Minutes	4 Hours

All times are based on 70° F (21° C).

CRL Dual Plunger Duramix™ Cartridge Gun

- For Use with All Duramix™ Cartridges



Dual Plunger Duramix™ Cartridge Gun is designed to accept all Duramix™ cartridges. Its friction feed ratcheting device allows for smooth professional beads. Large trigger dispenses sealant with an easy pull.

CAT. NO. CRL5500

CRL Duramix™ Static Mixer Nozzles

- For Use with All Duramix™ Cartridges



Static Mixer Nozzles are the key to Duramix™. Inside each nozzle is a series of blades to continually cut and mix the material so when it reaches the tip it is fully mixed. Each application usually requires a new tip (unless continual flow of material is maintained), so we suggest you stock up on extra nozzles. Must be ordered in increments of 12 nozzles.

CAT. NO.	QTY/BOX
CRL5700	12



CRL 3M® Auto-Mix™ Adhesive System

- Extremely Fast Setting – One Hour Cure
- Faster, Easier Side Glass Bonding

Auto-Mix™ Channel Bonding and Sidelite Adhesive is a fast-curing, two-part epoxy product that lets you handle side glass replacement in a hurry. Extremely flexible when cured, it gives you added assurance that the bonded glass will resist vibration and shock, and stay firmly bedded in the channel.

Using the handy Auto-Mix™ Applicator Gun, the adhesive is quickly and neatly applied just where you want it. After application, Auto-Mix™ Channel Bonding and Sidelite Adhesive has a four to five minute work life. Handling strength is reached in about 15 minutes, with full cure in one hour.

Combine this superior epoxy product with the convenience and precision of the Auto-Mix™ Applicator Gun, and you've got a side glass bonding system that is really outstanding!



[MSDS](#) [SPEC. DATA](#)

CAT. NO.	DESCRIPTION	CONTENTS	QTY/CASE
3M8641	Auto-Mix™ Adhesive	1.6 Fl. Oz. (47 ml)	6
3M8190	Auto-Mix™ Applicator Gun		
3M21791	Auto-Mix™ Mixing Nozzles (12 per Bag)		

CRL 3M® Structural Adhesive

- Powerful Bonding Strength for Steel, Glass, Rubber, Plastic and Fiberglass
- Can be Used to Secure Side Window Glass to Metal U-Channels, Rear View Mirrors to Windshields, Exterior Trim and Moldings to Body, Interior Trim Panels, etc.



CRL 3M® Structural Adhesive is a two-part general purpose structural adhesive that may be used for many structural and auto repair jobs. This powerful bonding system bonds steel, glass, rubber, plastic and fiberglass. Used for bonding auto glass to metal retainers, also for trim ornaments and miscellaneous fiberglass repairs. Mix an equal amount from each tube as needed for each repair. Each kit contains two each 2 fluid ounce tubes which, when mixed, makes four ounces of adhesive.

CAT. NO.	CONTENTS	QTY/CASE	MSDS	SPEC. DATA
3M8101	2 Fl. Oz. (59 ml)	6		

CRL Loctite® Poxy-Pak™ Clear Two-Part Epoxy

- Pre-Measured Resin and Hardener for Easy Application, Consistent Strength
- Resealable - No Waste
- Bonds Virtually Any Material



CRL Loctite® Poxy-Pak™ Clear Adhesive is a rapid cure two-part epoxy that reaches handling strength in about five minutes, and fully cures in 45 to 60 minutes. Poxy-Pak™ is easily dispensed from the two-cylinder syringe in any amount you need. It bonds metals, ceramics, concrete, wood, glass and most plastics. It's inexpensive to use, as the unused portion can be re-sealed and saved. May be drilled, tapped, sanded, machined and painted after it cures. Poxy-Pak™ cures at room temperature, and can withstand temperatures up to 300°F (149°C).

CAT. NO.	CONTENTS	QTY/CASE	MSDS	SPEC. DATA
81120	1 Fl. Oz. (29 ml)	12		

CRL Loctite® Fast Cure Epoxy

- Repairs Door Glass Pulled from Channel
- Sets in 10 to 15 Minutes
- Pre-Measured Individual Mixer Cups Means No Waste
- Bonds, Seals, Patches

CRL Loctite® Fast Cure Epoxy bonds, seals, and repairs almost anything in as little as 10 to 15 minutes. Repairs door glass channels, loose trim, broken plastic grills, and cracked or broken castings.



CAT. NO. 44581X10
Contains 10 – .12 Fl. Oz. Cups



CAT. NO. 44583X50
Contains 50 – 1 ounce cups



CAT. NO. 44583X10
Contains 10 – 1 ounce cups

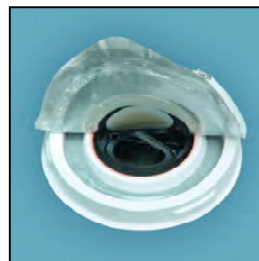

Zip Off Protective Film

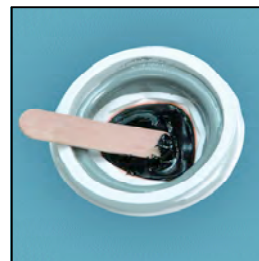

Pop the Mixer Cup



Mix Contents Thoroughly

Loctite® Fast Cure Epoxy features convenient no mess, no guess, no waste mixer cup packaging. Just zip off the protective film, pop the mixer cup, and mix the pre-measured contents thoroughly to assure consistent results. Bonds to glass, metal, plastic, wood, ceramic, marble, brick, concrete and many more surfaces. Gray color epoxy has a one year storage life.

To apply: Clean and dry surfaces thoroughly. Rough up the surface if possible. Apply the mixed epoxy to bonding area. Press surfaces together. Allow 15 minutes for cure. Loctite® Epoxy works at room temperatures, and can withstand temperatures up to 300°F (149°C).



CAT. NO.	CUP SIZE	QTY/PKG
44581X10	.12 Fl. Oz. (3.5 ml)	10
44583X10	1 Ounce (28 g)	10
44583X50	1 Ounce (28 g)	50



CRL Loctite® Minute Bond Adhesive and Primer

- Clear Color Makes it an Excellent Rear View Mirror Bracket Adhesive
- Specified by Major Domestic and Import Auto Manufacturers
- Joins Glass to Metal Permanently in Just Seconds
- Four Kit Sizes Including Handy Single Application Size

CRL Loctite® Minute Bond Adhesive permanently bonds non-porous materials such as glass, metal, tile, coated wood, plastics and nylon with superior strength holding power up to 3,000 psi. The combined primer and adhesive two-step application offers handling strength in 10 seconds, 60% full strength in two minutes, and a full cure in 24 hours. Kits contain both adhesive and primer.



CAT. NO. 0144
1.69 Fl. Oz. Kit



CAT. NO. 3325
0.8 Fl. Oz. Kit



CAT. NO. 3346
0.2 Fl. Oz. Kit



CAT. NO. 30814
0.02 Fl. Oz. Kit



CAT. NO. 73656
Primer Improves Bond Strength



Note: Minute Bond Adhesive is only recommended for use on non-porous flat surfaces that are to be mated together with a gap of .004-inch maximum. Where bond gaps are large, up to a maximum of .02 inch, or faster cure speed is required, primer should be applied to both surfaces. Primer should be 72°F (22°C) or warmer.

CAT. NO.	CONTENTS	QTY/BOX	MIN. ORDER
0144	1.69 Fl. Oz. (50 ml) Adhesive / 6 Oz. (170 g) Primer	5 Kits	1 Kit
3325	0.8 Fl. Oz. (24 ml) Adhesive / 6 Oz. (170 g) Primer	5 Kits	1 Kit
3346	0.2 Fl. Oz. (6 ml) Adhesive / 1.33 Oz. (38 g) Primer	12 Kits	1 Kit
30814	0.02 Fl. Oz. (0.59 ml) Adhesive / 0.02 Oz. (0.59 ml) Primer	12 Kits	1 Box
73656	6 Oz. (170 g) Minute Bond Primer	10 Cans	1 Can

CRL Loctite® Super Bonder Adhesive

- Bonds Instantly
- No Mixing
- No Mess



CAT. NO. 49504



CAT. NO. 49550

CRL Loctite® Super Bonder Adhesive sets in seconds to form a permanent transparent bond. It's effective on metal, rubber, aluminum, ceramics, vinyl, alloys, plastics and other non-porous surfaces. Comes ready to use.

CAT. NO.	CONTENTS	QTY/ CASE
49550	1 Oz. (28 g)	6
49504	0.1 Oz. (3 g)	12

Minimum order is one each.

CRL Loctite® Prism™ Instant Adhesives

- Fast Curing Gel Bonds Non-Porous and Porous Surfaces
- Highly Resistant to Solvents, Weathering and Temperature Extremes



CAT. NO. 45404
High Viscosity



CAT. NO. 40104
Medium Viscosity



CAT. NO. 40140
Medium Viscosity

Use CRL Loctite® Prism™ in places where you could never use instant adhesives before. Prism™ goes beyond typical cyanoacrylate adhesives to perform on wood, leather, ceramic, paper, foam, rubber, fabric, metal, plastic or elastomeric materials. Prism™ also works on acidic surfaces, such as freshly plated or coated metal parts.

CAT. NO.	CONTENTS	DESCRIPTION	QTY/CASE
45404	0.1 Oz. (3 g)	High Viscosity Gel	30
40104	0.1 Oz. (3 g)	Medium Viscosity Gel	30
40140	0.7 Oz. (20 g)	Medium Viscosity Gel	10

Minimum order is one each.

CRL Loctite® Plastix™ Advanced Plastic Bonder with Surface Activator

- Guaranteed to Fix ABS, Acrylic, Formica, PVC, Plexiglass, Polyethylene, Polypropylene, Polycarbonate, Phenolic and Vinyl
- Tight Bonds in Under a Minute



CRL Loctite® Plastix™ Advanced Plastic Bonder repairs all types of plastics: ABS, acrylic, Formica, melamine, plexiglass, polyethylene, polypropylene, styrene and vinyl. Polypropylene, polyethylene, PTFE and thermoplastic rubber are normally difficult to bond. However, when treated with the Surface Activator, adhesion can be achieved. Activator is only recommended for difficult to bond surfaces. No guesswork required here, just follow the simple instructions for a quick, neat and easy repair in less than a minute, with no mixing required!

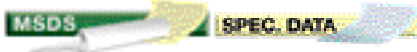

CAT. NO.	CONTENTS	CARDS/CASE
82565	.10 Fl. Oz. (3 ml) Activator/.07 Fl. Oz. (2 ml) Bonder	6

CRL Loctite® Threadlocker

- Locks and Seals Against Loosening from Vibration
- Protects Threads from Corrosion

CRL Loctite Threadlocker eliminates the need for stocking costly lock nuts and lock washers. This blue-colored sealer locks nuts in place, and keeps them from loosening due to vibration. The medium strength formula allows nuts to be removed for disassembly using normal hand tools.



CAT. NO.	CONTENTS	QTY/CASE
24231	1.69 Fl. Oz. (50 ml)	10
24221	.34 Fl. Oz. (10 ml)	10

CRL Loctite® Threadlocker Stick

- Semi-Solid Stick
- Less Mess, Less Waste

new



Same formula as liquid Loctite 242 Threadlocker, except in a new semi-solid stick form. Delivers the same trusted performance without the mess and waste. Convenient and portable, this medium strength threadlocker eliminates loosening from vibration, shock and thermal expansion.

CAT. NO.	CONTENTS	QTY/CASE
37087	0.67 Fl. Oz. (19 g)	10
37684	0.32 Fl. Oz. (9 g)	10

CRL Smart Glue® 5-Minute Epoxy Gel

new

- Foolproof - No Measuring
- Sets in Just Five Minutes
- Dries to a Durable, Flexible, Waterproof, Translucent Bond

CRL Smart Glue® Epoxy Gel in single use mixer packs are the neat and easy way to work with epoxy adhesive. The single use package is designed to hold, mix and dispense small, pre-measured doses of this epoxy gel, eliminating the need for messy measuring and mixing. Smart Glue® Mixer Packs are foolproof - just squeeze the epoxy through the burstable seal with a pencil and tear or cut off the tip to use. Smart Glue® may be used as a general-purpose adhesive to bond wood, metal, fiberglass, ceramics, glass and many hard plastics. Each package contains four single-use 3 gram disposable units. Total of 12 grams per package.



CAT. NO.	CONTENTS	PACKAGES/CASE
60032	.4 Oz. (12 g)	24

CRL Loctite® Form-A-Thread

- Repairs Threads in Less Than One Hour
- Easy for Professionals or Do-It-Yourselfers

Form-A-Thread repairs almost all fastener sizes and thread grades. It eliminates the need for special kits or inserts. Form-A-Thread maintains the thread size, so you can re-use the original fastener.

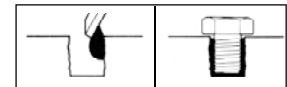

CAT. NO.	CONTENTS	QTY/CASE
28654	.32 Fl. Oz. (9.5 ml)	6

Just spread Form-A-Thread™ in the hole
Forms new reusable threads fast

CRL QuikSteel Epoxy Putty

- Dries Steel-Hard in 15 Minutes; Full Cure in 60 Minutes
- Mixes Like Putty and Easy to Use

CRL QuikSteel Epoxy Putty is a steel-reinforced material that sets in four minutes, dries steel-hard in 15 minutes, and fully cures in 60 minutes. Permanently bonds to aluminum, brass, copper, steel, PVC, fiberglass, plastics, glass, ceramics, wood and more.



CAT. NO.	CONTENTS	QTY/CASE
16002	2 Fl. Oz. (57 g)	6



CRL Spray Adhesive

- For Permanent or Temporary Bonds to Cardboard, Paper, Glass, Wood, Cloth, Metal, Plastic and Foam Rubber
- Quick Tack and Water Resistant
- Industrial Strength

CRL Spray Adhesive is an easy-to-use industrial strength cement for installing insulation, attaching gaskets, joining foam rubber, applying labels, mounting sanding discs, tacking cloth, and dozens of other uses in the shop, factory or home. CRL66 makes a permanent or temporary bond that will not wrinkle, and is water-resistant.



CAT. NO.	NET WEIGHT	QTY/CASE
CRL66	11 Oz. (312 g)	12



CRL 3M™ 77 Spray Adhesive

- Fast Drying
- Heat and Water Resistant
- Uniform Spray Application

3M™ 77 Spray Adhesive is a strong, translucent, fast-drying, multi-purpose adhesive for permanently attaching foils, cloth, carpeting, foams, paper, cardboard, felt, etc. to metal, wood, hardboard and other base materials. Aggressive, high initial tack allows sufficient "positioning" time. It's an extremely versatile adhesive for the shop or home.



CAT. NO.	NET WEIGHT	QTY/CASE
3M77	16.75 Oz. (475 g)	12



CRL Sprayway Multi-Purpose Spray Adhesive

- Heavier-Bodied Multi-Purpose Industrial Grade Spray Adhesive
- Fast Tack and Long Tack - 30 Minute Open Time
- High Coverage and Repositionable

CRL Sprayway Multi-Purpose Spray Adhesive is a high quality, industrial grade spray adhesive. It bonds lightweight materials such as metal, foil, gaskets, sanding discs, cloth, felt, fiberglass insulation, flexible foam, plastic films, polystyrene foam, cardboard, cork, etc.



CAT. NO.	NET WEIGHT	QTY/CASE
SW88	14 Oz. (397 g)	12



CRL 3M™ Spray Trim Adhesive

- Bonds Lightweight Automotive Trim
- Fast Drying, Clear Color
- Convenient, Easy-to-Use Spray

Use CRL 3M™ Spray Trim Adhesive for attaching various auto trim such as upholstery cloth, floor mats, carpeting, kick pads, and silencer pads to painted or bare metal, wood, K.B. board or other trim materials.

NOTE: Not recommended for use on vinyl materials or automotive headliners. For attaching vinyl use 3M™ Super Trim Adhesive, Cat. No. 3M8090 (shown below).



CAT. NO.	NET WEIGHT	QTY/CASE
3M8074	16.8 Oz. (476 g)	6



CRL 3M™ Underseal™ Undercoating

- Rubberized Formula Helps Protect Underside of Vehicle
- Deadens Sound

3M™ Underseal™ Undercoating is a totally new, rapid drying, rubberized undercoating material in an aerosol container. Designed for rustproofing and sound deadening; also for sealing fenders, quarter panels, door panels, repaired sections, welded joints, hoods, and decks. Easy to apply, and won't plug nozzle.



CAT. NO.	NET WEIGHT	QTY/CASE
3M38883	17 Oz. (481 g)	12



CRL 3M™ Super Trim Adhesive

- Bonds Vinyl Tops, Heavyweight Headliners
- Convenient, Easy-to-Use Spray
- Long Bonding Range

3M™ Super Trim Adhesive is a contact adhesive designed for bonding vinyl tops, heavy weight headliners, and hood silencer pads where high strength and heat resistance is needed. Provides high immediate bond strength and is repositionable during assembly. Excellent heat, water, and plasticizer resistance.

NOTE: Not recommended for polyethylene, polypropylene or foamed polystyrene.



CAT. NO.	NET WEIGHT	QTY/CASE
3M8090	19 Oz. (539 g)	6



CRL Chilton 12 to 1 Ratio Caulking Gun

- Heavy-Duty Strap Frame Gun is Our Most Popular Model



CAT. NO. WG41004

CRL Extra Thrust 18 to 1 Ratio Caulking Gun

- Ideal for Use in Cold Weather or with High Viscosity Sealants



CAT. NO. WG41004XT

CRL Deluxe Ascot 26 to 1 Ratio Caulking Gun

- Effortless Dispensing of High Viscosity Sealants
- New Stronger Frame Design

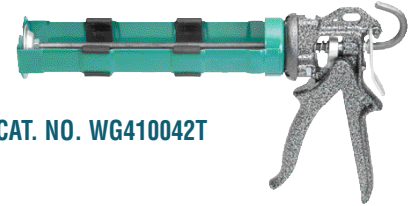

CAT. NO. WG410042T

CRL High Ratio Caulking Guns have the smooth operation of a friction rod, plus a large contoured handle and trigger. The strong metal frames hold all standard size caulking cartridges. The Chilton 12 to 1 Ratio Caulking Gun (Cat. No. WG41004) is our most popular gun. The Extra Thrust 18 to 1 Ratio Gun (Cat. No. WG41004XT) makes it even easier to dispense stiff bodied sealants and adhesives, such as automotive urethanes. The Deluxe 26 to 1 Ratio Caulking Gun (Cat. No. WG410042T) is the ultimate for dispensing high

viscosity urethane sealants. It includes new cartridge locating straps for holding slightly smaller diameter European cartridges.

All three guns feature a spring release plunger to load and dispense quickly and easily, and a pressure release on the plunger to prevent sealant run-on. A special feature of these guns is the Wear Compensating Device that minimizes wear on the applicator by automatically taking up the slack to provide total trigger action from first use to last. Will approximately double the life of the gun.

CRL 12 to 1 Ratio Avon 15" Sausage, Cartridge and Bulk Loading Gun

- Our Most Popular Manual Sausage Gun Converts for Gunning Sausage Packs, Cartridges or Bulk Load Material
- Quick Release End Cap



CAT. NO. WG51001

The CRL 12 to 1 Ratio Avon 15" Sausage, Cartridge and Bulk Loading Gun is made of lightweight aluminum. It is ideal for dispensing automotive urethane sealants in sausage packs, or waterproofing applications where wide beads of material are required. Gun comes with three yellow cone nozzles, ladder hook and spanner wrench. Also accepts standard 10.3 fl. oz. (304 ml) cartridges, plus bulk material. Pre-configured for 10, 15, and 20 ounce (295, 443, and 590 ml) sausage packs.



Replacement Nozzles
CAT. NO. WGCN

CRL Powerglide No-Drip Caulking Gun

- Automatic Mechanism Stops Drips Automatically
- Smooth Rod



CAT. NO. Z349

The Powerglide No-Drip Caulking Gun uses an exclusive automatic mechanism that creates a "vacuum" between the plunger and the caulking cartridge. When you release the trigger the material flow stops automatically. Frame has built-in nozzle piercing wire.

CRL Vacuum Action No-Drip Caulking Gun

- Stops Drips Automatically
- Smooth Rod



CAT. NO. Z343

This heavy-duty, cradle type No-Drip Caulking Gun features an exclusive vacuum action mechanism for no-drip caulking. Smooth operating, it features a strap, a nozzle cutter, and a piercing wire.

Caulking Gun Ratios-What Does It Mean? Extra Thrust!

Today's high viscosity sealants have brought about a new age of caulking guns. The question is what does the term "ratio" really mean? Quite simply, for every pound of pressure exerted by the user, the ratio is a multiplier of pounds of pressure being exerted on the cartridge plunger. For example, with the 12 to 1 Ratio Caulking Gun, if you squeeze the handle with 1 pound of pressure it puts 12 pounds of pushing pressure on the cartridge plunger. This "Mechanical Advantage" is being achieved by leverage, making your job easier.



CRL CAULKING GUNS

For Pricing on CRL Products, Call Toll Free (800) 421-6144, or Visit crlaurence.com

CRL Air Power 20 Ounce Sausage Caulking Gun

- Dispenses 10, 15.2 or 20.3 Fluid Ounce Sausages
- Lightweight Aluminum Body
- Quick Release End Cap

The CRL Air Power Sausage Caulking Gun has a lightweight drawn aluminum body yet dispenses even heavy materials, such as auto urethanes, at a smooth, controlled rate of flow. Can be used with 10, 15.2 or 20.3 fluid ounces (295, 450 or 600 ml) sausage packs. The high flow trigger valve is responsive, with a built-in regulator to control flow, and an instant release valve with a silencer to stop material flow. Can operate at up to 100 psi maximum.



CAT. NO. WG6100620

CRL Piston Rod Air Power Caulking Gun

- Dispenses Standard Cartridges and 10 Ounce Sausage Packs
- Piston Rod Thrust Prevents Sealant Contamination
- Lightweight Aluminum Body
- Quick Release End Cap

The CRL Piston Rod Air Power Caulking Gun dispenses even heavy materials, such as auto urethane, at a smooth, controlled rate of flow. The piston rod thrust prevents material contamination by using compressed air, so you can use it with standard 10.3 fluid ounce (305 ml) cartridges, or 10 fluid ounce (295 ml) sausage packs. The high flow trigger valve is responsive, with a built-in regulator to control flow, and an instant release valve to stop material flow. Operates at up to 100 psi maximum.



CAT. NO. WG61004

CRL Air Power Caulking Gun

- Dispenses All Standard Size Cartridges
- Lightweight Aluminum Body
- Quick Release End Cap

This CRL Air Power Caulking Gun is a superb quality, lightweight air powered dispenser for all standard size cartridges. Gun dispenses materials smoothly and uniformly with just a trigger squeeze, and connects to standard 1/4" air hose fittings. It has an instant release valve to stop material flow, true air regulator, and can operate at up to 100 psi maximum. The body is made of lightweight drawn aluminum with a quick release end cap for fast change out of cartridges. A quick disconnect fitting is included, and replaceable parts are available for all components.



CAT. NO. WG61001

LOG ON TO crlaurence.com FOR BUSINESS-TO-BUSINESS SERVICES

PHONE (800) 421-6144 | FAX (800) 262-3299 TOLL FREE FROM ANYWHERE IN THE U.S.A. OR CANADA | A141



CRL CAULKING GUNS

For Pricing on CRL Products, Call Toll Free (800) 421-6144, or Visit crlaurence.com

CRL Variable Speed Cordless Caulking Guns are ideal for glazing contractors, auto glass installers, building contractors, roofers, cabinet makers, OEM fabricators, window manufacturers, or anyone who applies lots of sealant and wants an easier, more professional way of getting the job done, without the restrictions of cords or hoses.

Our CG482N1 and CG48SG Guns feature a variable speed dial for controlling the flow of the sealant, and a quick release end cap for fast cartridge re-loading. Guns feature: dripless mechanism to prevent sealant run-on; rapid plunger release for fast re-loading; cut-off switch that stops the unit when the plunger reaches the end of the cartridge; soft grip handle with safety wrist strap.

CRL 4.8 Volt Variable Speed Cordless Cartridge/Sausage Caulking Gun Kits for Auto Glass Urethane Adhesives

- Dispenses 15.2 Fl. Oz. Sausage Packs or 10.5 Fl. Oz. Cartridges with the Same Barrel



Our fast loading, variable speed CRL Cordless Caulking Gun will dispense 30 to 32 standard size cartridges or 20 to 21 15.2. Fl.Oz. sausage packs on a full charge. Total weight with battery is only 4.6 pounds (2.1 kg), so it's highly maneuverable.

CAT. NO.	DESCRIPTION
CG482N1*	4.8 Volt Cordless Cartridge/Sausage Caulking Gun Kit
CG48B	4.8 Volt Battery Pack
CG48C	Battery Charger

* CG482N1 includes one gun, battery, charger and molded case.

This CRL 4.8 Volt DC Rechargeable Battery is used with the CG48C One Hour Charger to power the CG482N1 and CG48SG Cordless Caulking Guns. By having an extra battery, you can be charging one battery while the other is in use for continuous gunning and uninterrupted production.



CG48B Battery

- Dispenses 20.3 Fl. Oz. Sausage Packs or 10.5 Fl. Oz. Cartridges with the Same Barrel



This variable speed CRL Cordless Caulking Gun has a large, see-through barrel that will accommodate 20.3 Fl.Oz. sausage packs. It can dispense 30 to 32 standard size cartridges or 15 to 16 large sausage packs on a full charge. Total gun weight with battery is only 4.6 pounds (2.1 kg).

CAT. NO.	DESCRIPTION
CG48SG*	4.8 Volt Cordless Sausage/Cartridge Caulking Gun Kit
CG48B	4.8 Volt DC Battery Pack
CG48C	Battery Charger

* CG48SG includes one gun, battery, charger and molded case.

This CRL One Hour Battery Charger charges the CG48B 4.8 Volt Battery that is used with the CG482N1 and CG48SG Cordless Caulking Guns. Charger plugs into any 110V AC outlet.



CG48C Charger

Comparison Data Chart – Cordless Caulking Guns

SPECIFICATION	CRL CG482N1	CRL CG48SG	MILWAUKEE 656021	MILWAUKEE 656023	MILWAUKEE 656024	MILWAUKEE EZ581
POWER	4.8 Volts	4.8 Volts	12 Volts	12 Volts	12 Volts	2.4 Volts
WEIGHT WITH BATTERY	4.6 lbs. (2.1 kg)	4.6 lbs. (2.1 kg)	6.7 lbs. (3.0 kg)	7.7 lbs. (3.5 kg)	7.1 lbs. (3.2 kg)	3.8 lbs. (1.7 kg)
MODEL CONFIGURATION	10 Fl. Oz. Cartridge and 15 Fl. Oz. Sausage Pack	10 Fl. Oz. Cartridge and 20 Fl. Oz. Sausage Pack	10 Fl. Oz. Cartridge	29 Fl. Oz. Quart Cartridge	20 Fl. Oz. Sausage Pack	10 Fl. Oz. Cartridge
SPEED TO DISPENSE ENTIRE TUBE OR SAUSAGE	32 seconds PWR600HV 44 seconds PWR615HV	32 seconds PWR600HV 44 seconds PWR615HV	43 seconds PWR600HV	No Test	51 seconds PWR615HV	44 seconds PWR600HV
EXPEL FORCE	310 psi	310 psi	620 psi	620 psi	620 psi	290 psi
CHARGING TIME	1 Hour	1 Hour	1 Hour	1 Hour	1 Hour	1 Hour
DISPENSING CAPACITY PER CHARGE	32 Cartridges 21 Sausages (15 Fl. Oz.)	32 Cartridges 21 Sausages (15 Fl. Oz.) 16 Sausages (20 Fl. Oz.)	79 Cartridges (10 Fl. Oz.)	26 Cartridges (29 Fl. Oz.)	52 Sausages (15 Fl. Oz.) 39 Sausages (20 Fl. Oz.)	10 Cartridges (10 Fl. Oz.)

All models shown here have these features: Variable Speed Control, Automatic Shut-Off, Overload Clutch, and Dripless Mechanism



LOG ON TO crlaurence.com FOR BUSINESS-TO-BUSINESS SERVICES

A142 | PHONE (800) 421-6144 | FAX (800) 262-3299 TOLL FREE FROM ANYWHERE IN THE U.S.A. OR CANADA

CRL CAULKING GUNS

For Pricing on CRL Products, Call Toll Free (800) 421-6144, or Visit crlaurence.com

CRL Milwaukee® 12V DC Variable Speed Cordless Caulking Guns

- Includes 12 Volt Battery and One Hour Charger
- Easily Dispenses High Viscosity Auto Urethanes
- Interchangeable Front Ends Work with Standard Cartridges, 29 Fl. Oz. Quart Cartridges, and 20.3 Fl. Oz. Sausage Packs

new



CAT. NO. 48111960
12 Volt Battery



CAT. NO. 48111024
14.4 Volt Battery



CAT. NO. 48590245
One Hour Charger



CAT. NO. 48590184
One Hour Vehicle Charger

This heavy-duty 12V DC Cordless Caulking Gun makes manual caulking obsolete. A powerful pushing force of 620 pounds easily dispenses high viscosity materials such as automotive urethanes. Gun features include: variable speed trigger for smooth start up and reduced fatigue; manual clutch release for rapid loading of material; auto reverse (stops sealant flow when trigger is released); auto shut off at the end of plunger rod travel; 360° carriage rotation for easy work around corners and hard to reach areas. Guns are ordered pre-configured for the type of packaging to be used: standard 10 ounce cartridges; 29 ounce quart cartridges; 20 ounce sausage packs. Additional front ends and plunger rods can be special ordered to convert the gun to any configuration. All gun kits come standard with a 12V DC Battery Pack and One Hour Charger. The optional 14.4V DC 2.4 Amp-Hour Power Plus Battery Pack is also available. Charge either battery with the Power-Plus Universal One Hour Charger or One Hour Vehicle Charger.



CAT. NO. 656021
Standard Cartridge Gun



CAT. NO. 656023
Quart Cartridge Gun



CAT. NO. 656024
20 Fl. Oz. Sausage Pack Gun

CAT. NO.	DESCRIPTION
656021	Cartridge Gun, 12 Volt DC Battery and One Hour Charger
656023	Cartridge Gun, 12 Volt DC Battery and One Hour Charger
656024	Sausage Gun, 12 Volt DC Battery and One Hour Charger
48111960	12 Volt DC 1.3 Amp Hour Power-Plus Battery Pack
48111024	14.4 Volt DC 2.4 Amp Hour Power-Plus Battery Pack
48590245	Power-Plus Universal One Hour Charger
48590184	Power-Plus Universal One Hour Vehicle Charger

CRL Milwaukee® 2.4 Volt Cordless Caulking Gun

- Completely Portable, No Cords or Hoses
- One Hour Quick-Charge Battery and Charger
- Variable Flow Speed Control

This Milwaukee 2.4V DC Cordless Caulking Gun makes any sealant application job easier. Produces 290 psi at the plunger, with the One Hour Quick-Charge Battery Pack providing enough power to extrude up to 10 standard size cartridges of material before recharging. Visual indicator shows remaining adhesive.

CAT. NO.	DESCRIPTION
EZ581	2.4V DC Cordless Caulking Gun
EZ902	2.4V DC Battery Pack
RE580	Charger for 2.4V DC Battery



LOG ON TO crlaurence.com FOR BUSINESS-TO-BUSINESS SERVICES

PHONE (800) 421-6144 | FAX (800) 262-3299 TOLL FREE FROM ANYWHERE IN THE U.S.A. OR CANADA | A143



CRL CAULKING GUNS

For Pricing on CRL Products, Call Toll Free (800) 421-6144, or Visit crlaurence.com

CRL V-Notch and XL V-Notch Cutters

- Cuts Perfect V-Shaped Notches in Nozzles
- New XL Cuts Longer, Wider Notch in Nozzles

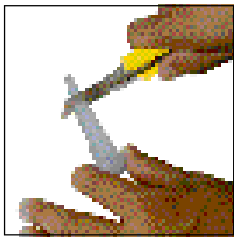

Cut Nozzle

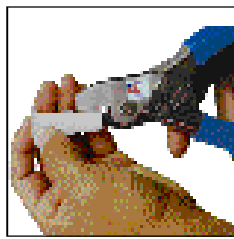

Insert Cutter

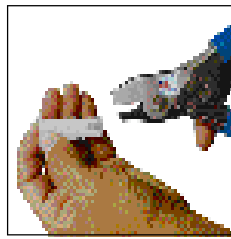

Cut V-Notch

Cutting the proper V-Notch on a urethane cartridge nozzle can be difficult and dangerous if you do not use the proper tool. CRL V-Notch and XL V-Notch Cutters are high quality tools that come with tempered steel jaws, a spring-loaded handle with non-slip plastic grips, and a thumb controlled jaw-locking device.

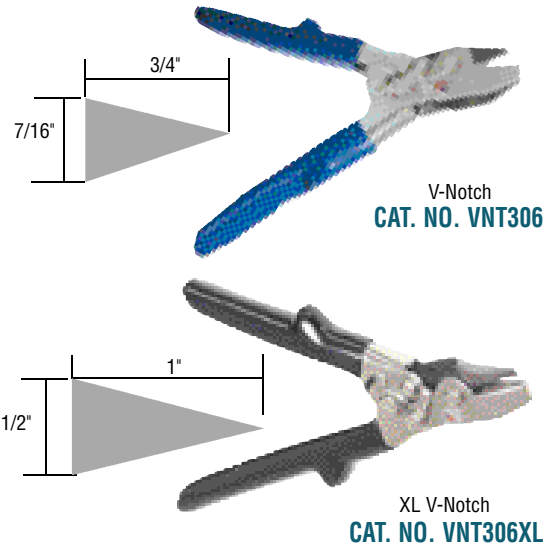

V-Notch
CAT. NO. VNT306

XL V-Notch
CAT. NO. VNT306XL

CRL Urethane Cartridge Opener

- Works Two Ways with Urethane in Metal Cartridges
- Also Punctures Wide Mouth Cartridges

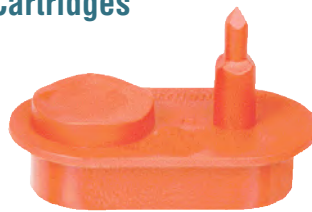

CAT. NO. UT0539

With the Urethane Cartridge Opener you press the rear of the metal cartridge over the serrated circle to remove the rear seal, then turn the cartridge over and press the front seal onto the pointed stem. Your cartridge of urethane is ready to use. It is made of a special plastic that urethane will not stick to, and is for use only with metal cartridges.

CRL Nozzle Cutter

- Cuts Both Nozzles and Plastic Front End Seals



CAT. NO. NC594

Here is a quick and easy way to cut the end off of the nozzle of a urethane cartridge. Put the nozzle in the cutter to the desired depth, squeeze the blade into the tool and the nozzle is cut. The other end has a V-shaped blade to remove the front-end seal from plastic cartridges.

CRL Reusable Caulk Tips

- Fits All Standard Cartridges

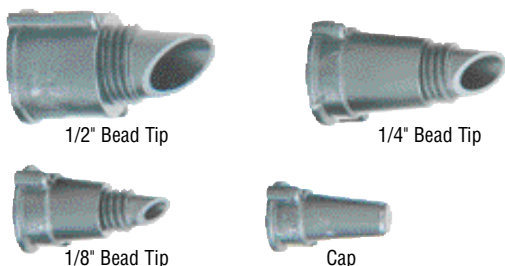

1/2" Bead Tip

1/4" Bead Tip

1/8" Bead Tip

Cap

Reusable Caulk Tips fit all standard cartridge nozzles, and can be used to give a consistent bead size. Screw 1/2" Bead Tip on cut cartridge nozzle. Use it alone for 1/2" Bead, or add 1/4" and 1/8" Bead Tips as needed. Tips are precut at 45°. Includes cut guide for cartridge nozzle, and nozzle cap to seal off tips.

CAT. NO. CT45

CRL Urethane Cartridge Holder

new

- Helps Eliminate Messes from Spilled Cartridges



Solves the problem of open boxes of urethane tipping over and spilling all over the inside of your truck or van. Drop urethane cartridges in the holder and you always have a visual inventory of how much urethane you have on hand. Made of rigid steel, it holds ten standard size cartridges of urethane.

CAT. NO. UTH577



LOG ON TO crlaurence.com FOR BUSINESS-TO-BUSINESS SERVICES

A144 | PHONE (800) 421-6144 | FAX (800) 262-3299 TOLL FREE FROM ANYWHERE IN THE U.S.A. OR CANADA

CRL Problem Solver Nozzles

- Eliminates the Need to Remove Molding, Windshields or Quarter Glass Panels
- Reaches Areas You Never Thought Possible
- Rigid or Flexible Styles

Designed by an auto glass expert, the CRL Problem Solver Nozzle eliminates the need to remove molding, windshields or quarter glass panels to fix leaks. Its narrow tip allows it to fit behind molding, headliners and dash tops, applying urethane directly to the leaking area from inside or outside the auto. It's a real time and money saver because it can pay for itself after only one use. Problem Solver Nozzles fit virtually any caulking cartridge by sliding over the existing nozzle, or screwing onto the threaded nipple. Nozzles are 8" long before trimming.

CAT. NO.	DESCRIPTION
PSN2	Rigid Nozzles (4 pack)
PSN4	Flexible Nozzles (4 pack)
PSN6	Combo Pack (2 Flexible, 2 Rigid)

Packs may be combined for quantity pricing.

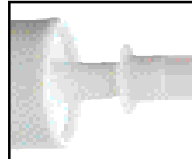
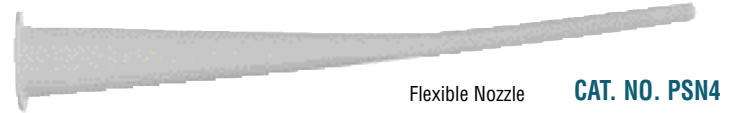

Fits Preformed Nozzles

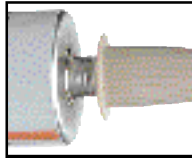

Fits Standard Threaded Cartridges



Reaches Those Hard to Get at Places

CRL Pre-Cut Urethane Nozzles

- Helps Direct Urethane to Right Location
- Threaded for All Standard Urethane Cartridges

A V-shaped cut in the tip of this nozzle allows for a smooth, consistent bead of adhesive. The tip extension helps you guide the nozzle at an even depth around the pinchweld opening. Pre-Cut Nozzles are helpful when installing rear sliders. The V-shaped notch directs urethane to the right location to make a proper seal, and reduces squeeze-out of excess adhesive. Sold only in packs of 12 nozzles.



CAT. NO. 690001

CRL Standard Tip Urethane Nozzles

- Threaded for All Standard Urethane Cartridges
- Can Be Trimmed for Larger Bead

CRL Standard Tip Screw-On Urethane Nozzles can be used as replacement nozzles for almost all automotive urethane adhesives, and are perfect for back fill operations. Sold individually.

NOTE: These nozzles will not fit POWR 300 Series Urethanes or silicone cartridges because of a different thread size. For POWR 300 Series Urethanes use Cat. No. PP3NOZ shown below. For silicone cartridges use the CRL Silicone Nozzle, Cat. No. S1LN0Z.



CAT. NO. UNOZ

CRL Nozzles for POWR 300 Series Urethanes

- Fit All POWR 300 Series Urethane Cartridges
- Provides Correct Bead for Windshield Installations
- Can Be Trimmed for Larger Bead

These Nozzles can be used with all of our POWR 300 Series Urethane Adhesives. A V-Notch mark shows you where to cut the nozzle for the type of bead that provides the best configuration for improved bonding. Sold in packages of 12 nozzles.

NOTE: These nozzles will only fit CRL POWR 300 Series Urethane cartridges, and cannot be used with other CRL Auto Urethanes.

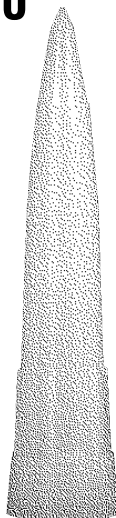

CAT. NO. PP3NOZ

CRL Little Red Nozzle Caps

- Economical and Reusable
- Reduces Sealant Waste

The Little Red Nozzle Cap is designed for capping cartridges of caulking, sealants and adhesives. Placed over the nozzle of partially used sealant cartridges, they seal out air and dirt to preserve the quality of the remainder of the product.



CAT. NO.	DESCRIPTION	QTY/PACK
LRC35	Little Red Nozzle Caps	35

CRL Adhesive Pumps

- Fit Standard Cone Top 6 to 16 Ounce (177 to 473 Milliliter) Cans
- Heavy-Duty Construction

CRL Adhesive Pumps fit standard six ounce to sixteen ounce (177 to 473 milliliter) cone top cans for dispensing your favorite adhesives, sealers, primers, and lubricants. Each size features a heavy-duty pump mechanism, four inch spout, and extra heavy-duty cap and spring. Both pumps can be easily disassembled for cleaning. Comes with wire plug to prevent dry-back in the nozzle. **NOTE:** To ensure long service life, all Adhesive Pumps should be kept clean.



CAT. NO. 180AG



CAT. NO. 181AG



CAT. NO.	DESCRIPTION
180AG	Small Pump Assembly
181AG	Large Pump Assembly

All Adhesive Guns and Pumps on this page can be combined for quantity pricing.

CRL 3M™ Pint Can Applicator Gun

- For Use with All Pint Cans of Flow Grade Butyl
- Easy Flow Pump
- Includes a Nylon Crevice Tip

This 3M™ Pint Can Applicator Gun is designed for use on 3M™ products with 16 fluid ounce (473 milliliter) cone top cans. The applicator gun allows for applications of very small beads, 1/16" to 1/8" (1.6 to 3.2 mm), that are required for gasket set windshields. Comes with wire plug to prevent dry-back in the nozzle.

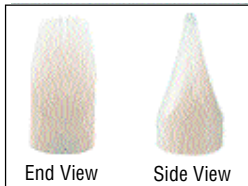
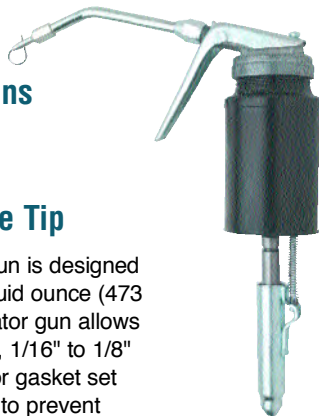

Nylon Crevice Tip

CAT. NO.	DESCRIPTION
3M8994	Applicator Gun

All Adhesive Guns and Pumps on this page can be combined for quantity pricing.



CRL Adhesive Guns

- Dispense Adhesives, Sealers, Primers, and Lubricants with an Easy Squeeze Lever
- Heavy-Duty Construction

Use CRL Adhesive Guns for dispensing your favorite adhesives, sealers, primers or lubricants. Both sizes feature a heavy-duty pump mechanism, four inch spout, and extra heavy-duty cap and spring. Both can be easily disassembled for cleaning. Comes with wire plug to prevent dry-back in the nozzle. **NOTE:** To ensure long service life, all Adhesive Pumps should be kept clean.



CAT. NO. 190AG



CAT. NO. 195AG

CAT. NO.	DESCRIPTION
190AG	6 Oz. (177 mm) Capacity Gun
195AG	16 Oz. (473 mm) Capacity Gun

All Adhesive Guns and Pumps on this page can be combined for quantity pricing.

CRL Rubber Seal Adhesive Gun

- Easiest Way to Dispense Adhesives, Sealers and Primers Directly from the Can
- Designed to Fit All Pint Cans

With one stroke, the CRL Rubber Seal Adhesive Gun pumps a bead four to five times the length of any other gun on the market. Designed to fit all pint cans, it is a fast, clean, and economical means of applying adhesives, mastics, and sealing materials. Just unscrew the can's lid and screw it on the gun. Comes with wire plug to prevent dry-back in the nozzle. **NOTE:** Adhesive Guns should be kept clean to ensure long service life.

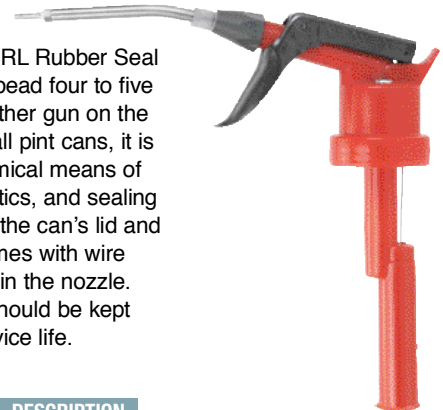

CAT. NO.	DESCRIPTION
716AG	Adhesive Gun

All Adhesive Guns and Pumps on this page can be combined for quantity pricing.

CRL Repair Kit for the 716AG Rubber Seal Adhesive Gun

This Rubber Seal Gun Repair Kit includes a new disc, pull spring, gasket, and all fasteners pictured.

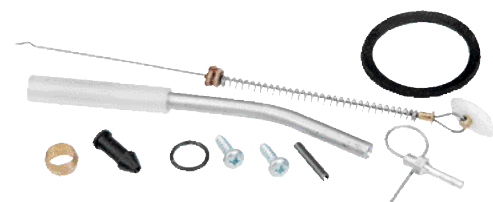

CAT. NO. RS164



CRL Adhesive Gun Tips

- Won't Scratch Glass
- Good for Spreading on Primer

Nylon Crevice Tip and Sealant Brush attach to our Adhesive Guns and Pumps. Use the Crevice Tip to get sealant into tight places without scratching the glass. The Brush Tip spreads sealant or primer over wider areas.

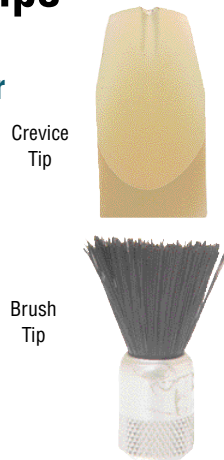

CAT. NO.	DESCRIPTION
KP3344	Crevice Tip
KP3298	Brush Tip

CRL Gun Fill Pump

- Fits Three and Five Gallon Straight Sided Pails
- Gives You the Economy of Bulk in Small Containers

This CRL Gun Fill Pump is designed to transfer bulk sealants, adhesives or lubricants from three or five gallon (11 or 19 liter) pails to convenient smaller containers. It is an 18" (45 cm) pump with a 12" (30.5 cm) diameter cover.



CAT. NO. GFD450

CRL Slip-N-Grip® Seat Covers

- Protects Your Customer's Seats for Pennies Each
- Improves Customer Confidence
- Inexpensive Compared to Cleaning Cost

These CRL Slip-N-Grip® Seat Covers can save you the cost of cleaning soiled or urethane stained interiors. Innovative and economical to use, these disposable CRL Slip-N-Grip® Covers have a unique two-sided design that clings to the seat without slipping, protecting the interior of your customer's vehicle. The 33" by 56" (83 by 142 cm) size fits virtually any seat. 250 large ready-to-use covers per dispenser box. Minimum order is one box.



CAT. NO.	SIZE	QTY/BOX
600088	33" x 56" (83 x 142 mm)	250

CRL Slip-N-Grip® Floor Mats

- Made of Tough Plastic, Not Paper
- Stay in Place on the Floor

new

CRL Slip-N-Grip® Floor Mats can help prevent soiled or urethane stained interiors. Disposable CRL Slip-N-Grip® Floor Mats have a unique two-ply design that stays put, without slipping, to protect the interior of your customer's vehicle. The 19" by 21" (482 by 533 mm) size covers virtually any floor area. 500 economical ready-to-use mats per dispenser roll. Minimum order is one roll.

CAT. NO.	SIZE	QTY/ROLL
6000721	19" x 21" (482 x 533 mm)	500



CRL Slip-N-Grip® Steering Wheel Covers

- Protects Steering Wheels from Grease and Spills
- Universal Fit

new

CRL Slip-N-Grip® Steering Wheel Covers protects steering wheels from grease, dirt, and spills that are inevitable when installing glass. The universal-fit covers easily slip over the steering wheel with elastic which also keeps them in place. Keep your customers happy and show them you care with a professional job well done. Minimum order is one box.

CAT. NO.	QTY/BOX
600099	250

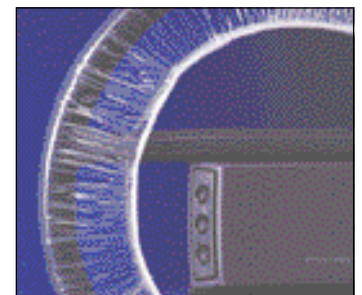

CRL and Sprayway, an Alliance of Two Industry Leaders Bringing You the Best in Glass Cleaners

- CRL is Sprayway's Master Distributor to the Glass Industry
- CRL's Glass Cleaners are Manufactured Exclusively for Distribution Through the Glass Industry
- All Glass Cleaners are Now Available from CRL in Cases of Twelve Big 19 Ounce (539 g) Cans



All Are Also Available With Your Logo or Private Label

Four Powerful Glass Cleaners to Fit Every Need



CAT. NO. S50

- Ammonia Free
- Spray and Wipe Clean
- Fast Evaporation

CRL S50 is Sprayway's leading glass cleaner, and has the CRL logo on the same 19 ounce can that you are familiar with. It has a fast evaporation rate, which keeps it from leaving a film and adversely interacting with other materials.



CAT. NO. 1973

- A Long Time Favorite of the Glass Industry
- Low-Ammoniated

CRL 1973 Glass Cleaner, a long time favorite of CRL customers, is a low-ammoniated glass cleaner that is now packaged in a new, easier-to-handle 19 ounce can. The same effective cleaning agents and pleasant aroma remain, with the added feature of Sprayway's logo.



CAT. NO. 2000

- CRL's Newest Formula Has Added Ammonia for Maximum Strength

Our new Hi-Shine 2000 Higher Ammoniated Glass Cleaner is formulated to handle your toughest dirt and grime situations with ease. Each 19 ounce can features the CRL logo the glass industry has grown to trust.



CAT. NO. CRL18X

- Our Best All Purpose Glass Cleaner for Around the House
- Extra Strong Ammonia Free Formula for Really Tough Cleaning Jobs

Use extra strong, ammonia free CRL18X Cleaner on glass, mirror, porcelain, enamel surfaces, ceramic tile, aluminum, brass and chrome. Excellent for really tough cleaning problems around the house or on the job site. Large 19 ounce cans include the CRL and Sprayway names known throughout the industry for quality cleaning performance.



Glass Cleaner Starter Kit

- Unsure Which Glass Cleaner is the Best for You?
- Sample Them All with Our Glass Cleaner Starter Kit

Our Starter Kit lets you try four CRL Glass Cleaners. Contains one 19 ounce (539 g) can of our S50, 1973, 2000 and CRL18X Glass Cleaners.



CAT. NO. 4CSK



CRL Logo Label and Private Label Aerosols

- You Can Now Get Any of the CRL-Sprayway Glass Cleaners and Other Quality Aerosol Products with Your Company's Name and Logo Right on the Can
- A Minimum Order of 40 Cases is All it Takes to Get Started



CRL Logo Label Program

- 40 Case Minimum Order (12 Cans Per Case)
- Choose from Nine of Our Most Popular Formulations, Including S50, 1973 and 2000 Glass Cleaners
- Freight Paid to Any Location in the Continental U.S.

The CRL Logo Label Program uses our label templates with designated areas for your company's name or logo, address and product name. We offer the same fine quality glass cleaners and lubricants that you are accustomed to using. We can manufacture and ship your first order in approximately four weeks from the date your input is received at the packaging plant. Call CRL Customer Service at (800) 421-6144 for details and pricing for this unique service.



CRL Private Label Program

- 60 Case Minimum Order (12 Cans Per Case)
- Choose from Many of Our Fine Formulations, Including S50, 1973 and 2000 Glass Cleaners
- Freight Paid to Any Location in the Continental U.S.

CRL's Private Label Program lets you choose from one color silk screen labeled white cans, one or two color cut and stack paper labels, or three and four color roll-fed varnished paper labels. Design your labels within our guidelines for that custom look. Your aerosols will ship to you in oyster white custom stenciled boxes. First orders take approximately six weeks, and re-orders can ship within 10 to 15 business days.



CRL Sprayway Pre-Moistened Glass Cleaner Wipes

- The Easiest and Quickest Way to Clean Glass and Aluminum
- Uses the Same Great Formula as Popular S50 Glass Cleaner
- Lint Free Wipes are Always Fresh and Ready to Use
- Pop-Up Lid Keeps Them Fresh



Pre-Moistened with a powerful ammonia free formula, these large 12" by 12" (305 by 305 mm) Wipes will remove dust, dirt, oil and grease smudges, water spots, fingerprints, and smoke film from any glass surface, and leave it with a dazzling shine. With a fast evaporation rate, they will not leave a film or adversely interact with other materials. Not only perfect for use on windows, but they are also great for cleaning and adding a bright luster to mirrors, aluminum extrusions, light fixtures, windshields, display cases, shower doors, glass tables, most computer screens, chrome, tile, and porcelain.

CAT. NO.	CONTENTS	QTY/CASE	MSDS
SW95	70 Wipes/Tub	6	

CRL Concentrate Glass Cleaner

- One Gallon Concentrate Makes 10 Gallons of Strong Cleaning Fluid
- Leaves No Film, Wipes Clean with No Rinsing
- Ammoniated for Strength
- Great for Use on All Auto Glass



The most popular glass cleaner for in-shop and on-the-job use. It's easy to use and leaves no film or smears on glass. 695 will not harm paint. It's easy to mix - one gallon makes ten gallons of strong, safe cleaning fluid. Use it with less water for those extra tough cleaning jobs. 695 is also available in 55 gallon drums for industrial users.

CAT. NO.	CONTENTS	QTY/CASE	MSDS
695	1 Gallon (3.785 l) Bottle	4	
69555GL	55 Gallon (208 l) Drum	1	

CRL Ready-Mix Glass Cleaner

- Ready-Mixed Bulk Liquid
- Available in Private Label for Your Resale

Our professional strength CRL Bulk Glass Cleaner is also available in these ready-mixed gallons for bulk filling of your spray dispensers. It's precisely formulated to give great glass cleaning results without the effort of mixing it yourself. Also available for resale in containers with your private label.



CAT. NO.	CONTENTS	QTY/CASE	MSDS
895GL	1 Gallon (3.785 l) Bottle	4	

CRL Plastic Spray Dispenser Bottle

- Ideal for Use with Concentrated or Bulk Glass Cleaner

Easy trigger operation sprays a large, fine mist pattern for best coverage of glass area. Easily cleaned valve and intake strainer. These dispensers replace and outlast expensive, high pressure aerosol containers.



CAT. NO.	SIZE
DB21	16 Fl. Oz. (473 ml)

CRL Bio-Clean Water Stain Remover

- Effectively Removes Water and Mineral Stains, Rust, Tree Sap, Paint Overspray, Soap Scum, and Mildew from Glass and Other Surfaces
- Works Great On: Shower Doors, Windows, Glass Surfaces, Tile, Fiberglass, Windshields, Chrome, Porcelain, Corian®, Anodized Brass and Aluminum, Stainless Steel, and Hard Vinyl

Apply CRL Bio-Clean to a surface with a dry cloth, sponge, brush or oscillating buffer. Press firmly to loosen stain with a rubbing action, then just rinse with water until residue free. Can be reapplied as needed until surface is clean.

CAT. NO.	CONTENTS	QTY/CASE
WSR1	16 Fl. Oz. (473 ml)	12



- Removes Stage One Corrosion Quickly

Stage One Corrosion is defined as glass with light corrosion, and little or no damage to the glass. Stage Two Corrosion occurs when the deposits are no longer on the surface of the glass, but have started to break down the molecular structure of the glass, leaving an etched or white haze on the glass after the stain has been removed. CRL Water Stain Remover will not repair glass with Stage Two Corrosion.



CRL "Sparkle" Cleaner and Stain Remover

- Cleans Light Water Stains from Glass
- Use on Auto Glass for Water Spots

CRL "Sparkle" Cleaner does those glass cleaning jobs too tough for spray-on cleaners. It removes light water spots and stains in glass caused by weather, sea air, or pollution; also removes soap scum from shower doors and ceramic tile. Use it on auto glass to remove water spots from automatic windshield washers. Wipe on with a damp cloth or paper towel, rub stained areas, then wipe off.

CAT. NO.	CONTENTS	QTY/CASE
SP101	8 Fl. Oz. (236 ml)	12



CRL TPC Surface Protector

- Transparent Polymer Coating
- Water, Soil, and Stain Repellant
- Protects Glass and Many Other Surfaces

CRL TPC Surface Protector will actually seal the pores of glass, porcelain, ceramic, plastics, polished metals, fiberglass, and marble to make the surface water, soil, and stain resistant. The clear coating guards against the adhesion and build-up of dirt, grime, mold, mildew, rust, and mineral deposits. Environmentally friendly and non-toxic, CRL TPC Surface Protector permits the practice of preventive cleaning and maintenance, reducing costly cleaning, repairs, and replacement. One fluid ounce protects approximately 15 square feet of glass.

CAT. NO.	CONTENTS	QTY/CASE
TPC16	16 Fl. Oz. (473 ml)	12



LOG ON TO crlaurence.com FOR BUSINESS-TO-BUSINESS SERVICES

A150 | PHONE (800) 421-6144 | FAX (800) 262-3299 TOLL FREE FROM ANYWHERE IN THE U.S.A. OR CANADA

CRL Aerosol Plastic Cleaner

- Anti-Static, Anti-Fog, Non-Streaking Formula
- Fast Drying and Economical to Use

CRL Aerosol Plastic Cleaner is an anti-static, anti-fog, non-streaking formula that is fast drying and economical to use. Apply it to a variety of plastic materials: acrylic, Plexiglas, polycarbonates, and safety glazing panels. CRL848 wipes away without streaking, and leaves a sparkling clean surface. This large 19 ounce aerosol will clean a lot of plastic.

CAT. NO.	CONTENTS	QTY/CASE
CRL848	19 Oz. (539 g)	12



CRL Plastic Cleaner and Polish

- Contains No Abrasives
- Non-Static/Non-Glare
- Great for Removing Tiny Scratches

Developed especially for the glass industry, CRL Plastic Cleaner and Polish cleans and polishes virtually everything made of plastic. It's great for removing tiny scratches from acrylic windows in boats, campers, RV's, airplanes, or any other vehicle. It can polish the plastic on boat surfaces, seat covers, shower doors, Formica tops, etc. Handy and attractive squeeze bottles make it easy to carry, easy to apply, and a fast mover in over-the-counter sales.

CAT. NO.	CONTENTS	QTY/CASE
CRL10	8 Fl. Oz. (237 ml)	12



CRL Novus Plastic Polishes

- No. 2 for Fine Scratches
- No. 3 for Heavy Scratches

CRL offers two Novus Plastic Polishes in convenient eight fluid ounce bottles. CRL Novus No. 2 removes fine scratches, haziness, and abrasion from most plastic surfaces. It is not just a surface cover up, but will restore and protect. CRL Novus No. 3 removes heavy scratches and abrasions from most acrylic surfaces. Both polishes contain a light abrasive and are not for use on eyeglasses, polycarbonates, or coated plastics. Novus No. 2 should be used as a follow-up to Novus No. 3 for best results.

CAT. NO.	DESCRIPTION	CONTENTS
PN7030	Novus Polish No. 2 (Fine)	8 Fl. Oz. (237 ml)
PN7080	Novus Polish No. 3 (Heavy)	8 Fl. Oz. (237 ml)



CRL General Purpose Solvent and Adhesive Cleaner

- Removes Uncured Adhesives
- The Perfect Clean-Up Companion for Urethane Users

CRL General Purpose Solvent and Adhesive Cleaner can handle some of the toughest cleaning jobs in your shop. Use it to soften and remove uncured urethane, adhesive, tar, grease, oil, body sealer, and undercoating. Apply to a rag and rub lightly over soiled areas, then wipe up with a clean, dry cloth. **NOTE:** Be sure to observe all safety recommendations during use of this extra strong cleaner.



CAT. NO.	CONTENTS	QTY/CASE
CRL2032	32 Fl. Oz. (946 ml)	12

CRL 3M™ General Purpose Adhesive Cleaner

- Quickly Cleans Off Wax, Grease, Oil, Old Adhesive, Road Tar, and Silicone
- Will Not Dissolve Aged Automotive Paint
- Also Works on Vinyl or Glass Surfaces

3M™ General Purpose Adhesive Cleaner quickly cleans off wax, grease, oil, adhesives, road tar, silicone, etc. Used properly, it will not dissolve or mar automotive paint that has been properly aged. It's also suitable for use on vinyl or glass surfaces.



CAT. NO.	CONTENTS	QTY/CASE
3M8987	15 Oz. (425 g)	12

CRL 3M™ Woodgrain and Stripe Adhesive Remover

- Cleans Off Adhesive Residue After OEM Vinyl or Stripes Have Been Removed
- Jelly-Like Consistency Keeps Remover in Place on Vertical Surfaces
- Fast Acting in 3 to 5 Minutes

3M™ Woodgrain and Stripe Adhesive Remover is a fast acting spray that can be used on most properly cured automotive paints. Great for cleaning off adhesive residue after woodgrain vinyl or OEM vinyl stripes have been removed. Best when used with a plastic scraper, such as our Cat. No. 105 (See page A153).



CAT. NO.	CONTENTS	QTY/CASE
3M8908	18 Oz. (510 g)	6

CRL Quick Release Agent

- Quick Release of Most Adhesives
- Softens Butyl and Other Windshield Sealants

CRL Quick Release Agent makes removal of windshield glass easier. CRL958 is a solvent blend designed to loosen or dissolve most adhesives used for bonding automotive weatherstrip, carpeting, etc. It softens or undercuts butyl, oil-based, and polysulfide windshield sealers.



CAT. NO.	CONTENTS	QTY/CASE
CRL958	14 Oz. (397 g)	12

CRL Industrial Clean Up Dry Cleaner

- Removes Uncured Urethane, Sealants, Adhesives, Fresh Paint, Grease and More

CRL Clean Up Dry Cleaner has multiple industrial uses where stains and spills cannot be cleaned with typical water-based cleaners. It removes sealants, adhesives, uncured urethane, fresh paint, and grease from carpets, upholstery, clothing, painted surfaces, metals and more. Industrial Clean Up Dry Cleaner leaves no residue, and contains no chlorofluorocarbons to deplete the ozone. **NOTE:** Not for use on plastic.



CAT. NO.	CONTENTS	QTY/CASE
S732	20 Oz. (568 g)	12

CRL Sprayway Solvent Cleaner and De-Greaser

- Excellent Spray Cleaner for Grease, Tar, Crayon, and Ink
- Also Great for Removing Spots from Fabrics, Carpets, and Clothing
- Can Be Used on Electrical Motors

CRL Sprayway Solvent Cleaner and De-Greaser removes grease, tar, adhesive marks, crayon, lipstick, ink, and fresh paint, along with many other types of dirt and grime. SWC60 is also excellent for removing spots from fabrics, carpets, and clothing.



CAT. NO.	CONTENTS	QTY/CASE
SWC60	16 Oz. (454 g)	12



CRL Silicone Cleaner and Surface Prep

- Ideal For Removing Uncured Silicone and Many Cured Silicones
- Prepares Surfaces to be Sealed, Painted, or Bonded

CRL OS2 is a long needed answer to uncured silicone clean up. This spray works simply and easily to instantly dissolve silicone film. It also softens and removes many cured silicones. Spray or wipe it on, let soak, scrape before the material dries, then reapply and wipe with a clean cloth. Typical applications include: cleaning plastics, fiberglass, and components; pre-cleaning surfaces prior to painting, sealing and bonding; degreasing bearings, nuts, bolts, chains, and conveyor belts; removing silicone-based car wax and protectants; removing silicone, and pressure-sensitive adhesives (labels).

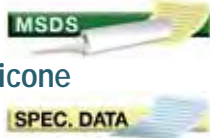

CAT. NO.	CONTENTS	QTY/CASE
OS2	10 Oz. (283 g)	12

CRL Sprayway Clean Jet 100

- Non-Flammable Dust Remover
- Strong Air Blasts for Non-Moisture Cleaning of Parts and Equipment
- Ultra Filtered - Leaves No Residue

Sprayway Clean Jet 100 is a compact portable source of ultra clean gas for precision removal of dirt, dust, lint, and particulates. Use Clean Jet 100 for cleaning and dusting of: office and computer equipment; keyboards, circuits, electronic devices; audio/visual recording equipment; photographic, x-ray film and equipment; clean rooms and laboratories.



CAT. NO.	CONTENTS	QTY/CASE
SW805	10 Oz. (284 g)	12

CRL Plastic Scraper

- Firm Double Edge Scraping Tool Won't Scratch Glass

This firm, double edge CRL Plastic Scraping Tool won't scratch glass surfaces. Use it to remove decals, stickers, labels, etc. from glass, or to apply window tint film. It's also handy for removing adhesive residue from woodgrain vinyl or pinstripes. Scraper measures 4" by 2-7/8" (102 mm by 73 mm).



CAT. NO. 105

CRL 3M Scotch® Adhesive Remover Pen new

- Citrus Base Formula Removes Sticky Adhesives, Adhesive Residue, and Marker Graffiti
- Convenient Pen Applicator

The 3M Scotch® Adhesive Remover Pen is ideal for the removal of adhesive residue, as well as for cleaning oils, grease, and grime. Works on most hard surfaces, including glass and metal. Test for compatibility on plastics. The convenient pen applicator precisely controls the amount of cleaner. Contents: .35 Oz. (10 g).



CAT. NO. 3M50021

CRL Methyl Ethyl Ketone

- Dissolves Uncured Sealants, Mastics and Adhesives
- Removes Oils from Metal Surfaces Prior to Sealant Application
- Excellent for Cleaning Tools and Equipment

CRL MEK (Methyl Ethyl Ketone) is a good solvent for general cleanup, as well as an excellent way to clean metal caulking guns, tools or dispensing equipment of uncured sealants, mastics, and adhesives. It's also excellent for removing oils and contaminants from aluminum surfaces prior to sealant application. Similar to acetone, though MEK dries slower, which allows time for proper two cloth method of cleaning ("wipe with second clean dry cloth before solvent evaporates to completely remove all contaminants").



CAT. NO.	CONTENTS	QTY/CASE
MEK1GL	1 Gallon (3.8 l)	4
MEK5GL	5 Gallon (18.9 l)	1



CRL Plastic Single Edge Razor Blades

- Won't Harm Surfaces that Could Be Damaged by Metal Razor Blades
- Fits Most Razor Blade Scrapers

These CRL Plastic Single Edge Razor Blades will not harm plastic coated windows or other hard surfaces that can be scratched or marred by metal razor blades. They are also useful for working on painted surfaces or chrome, and for removing decals, pin striping, or window tint film. Fits perfectly in our CRL761 Razor Blade Scraper (See page A178).



CAT. NO.	QTY/PACK
CP866088	100

CRL Alumin-Nu Metal Cleaner

- For Use On Aluminum, Brass, Copper, Nickel, Chromium, Stainless Steel and All Bright Metals
- Ideal for Removing Heavy Oxidation
- Leaves No Residue

This concentrated liquid restores metal to its original finish. It is a proven metal cleaner and polish for aluminum, copper, brass, bronze, nickel, chromium, and stainless steel. CRL Alumin-Nu not only cleans flat or extruded sections of metal, it is also used to clean metal plaques and relief work because it does not leave any residue in crevices. It dissolves accumulations of abrasives and grime that have been deposited by ordinary metal polishes. After the surface has been cleaned, a protective film remains which retards discoloration. Alumin-Nu applies easily with a soft cloth, and a little goes a long way.



CAT. NO.	CONTENTS	QTY/CASE
95060QT	32 Fl. Oz. (946 ml)	12 Quarts
95060GL	128 Fl. Oz. (3.785 l)	4 Gallons



CRL Armor All® Cleaner

- Leaves a Clean Finish that is Ready for Armor-All Protectant
- Cleans Rubber, Vinyl, Plastic, Finished Leather, and Sealed Wood

Use CRL Armor All® Cleaner to wipe away grime, dirty fingerprints, smudges on dashboards, door panels, or other vinyl surfaces. Leaves a clean finish that's ready to protect with Armor-All® Protectant (see below).



CAT. NO.	CONTENTS	QTY/CASE
30200	20 Fl. Oz. (590 ml)	12



CRL Autosol® Shine Metal Cleaner

- Cleans and Conditions in a Single Treatment
- Produces a Brilliant Gloss
- Low Ammonia Content



Ideal for all chrome, aluminum, stainless steel, brass, copper, gold, pewter, platinum, silver, and tin, as well as fiberglass, ceramic, and certain painted surfaces. Mild abrasives help to remove built-up tarnish, oxidation, and even rust, leaving behind a protective coating which helps to condition the metal and protect against corrosion while providing a longer lasting shine. Contains an extremely low ammonia content. Other brands with higher concentrations of ammonia can cause long term damage to metals that result in premature stress corrosion cracking. Consistently recommended by restoration experts and museums around the world.

CAT. NO.	CONTENTS	QTY/CASE
1188AS	2.5 Fl. Oz. (100 g)	24



CRL Armor All® Protectant

- Gives Long Lasting Protection to Leather, Rubber, Vinyl, Plexiglas, and Plastic
- Guards Against Ozone, Oxygen, and Ultraviolet Rays

CRL Armor All® Protectant guards against ozone, oxygen, and ultraviolet rays which crack, fade, and harden materials such as rubber, vinyl, plastic, finished leather, and sealed wood. Use it in the house, garage, or office to make surfaces look like new. Simply apply Armor All® with a cloth or sponge, or spray directly on the surface, and then wipe off to leave a shiny, protected finish. Anti-static to repel dust and dirt. To prepare the surface before application of Armor All® Protectant, use Armor All® Cleaner (see above).

CAT. NO.	CONTENTS	QTY/CASE
10320	32 Oz. (946 ml)	6 Quarts
10710	128 Fl. Oz. (3.785 l)	4 Gallons



CRL Sprayway Crazy Clean All Purpose Cleaner

- All Purpose Cleaner that Cleans and Deodorizes
- Great on Smooth Finishes

Great for all washable, painted surfaces, window sills, venetian blinds, and all porcelain and tile surfaces. Excellent for removing dirty hand prints from walls and doors, scuff marks on floors, crayon and grease spots, soot and smoke film. Also suitable for bathtubs, washbowls, toilet bowls, kitchen sinks, cabinets, stoves, and refrigerators. For best results, spray a small area until wet, let stand for several seconds, wipe off with a clean dry cloth, then rinse if desired. When using on plastic seat covers or plastic tile, rinse with a clean damp cloth.



CAT. NO.	CONTENTS	QTY/CASE
SW31	19 Oz. (539 g)	12

CRL Sprayway Stainless Steel Polish and Cleaner

- Cleans, Polishes, and Protects
- Resists Finger Prints, Grease, and Water Spatter
- Preserves the Factory Finish of Stainless Steel Window Frames

CRL Stainless Steel Polish and Cleaner cleans, polishes, and protects stainless steel without hard rubbing and polishing. Resists finger prints, grease, and water splatter. Helps preserve the factory finish. Stainless Steel Polish and Cleaner can be used on all types of stainless steel window frames, trims, doors, corridor guards, kick plates, dishwashers, refrigerators, freezers, sterilizers, etc. Also excellent for Formica, porcelain, ceramic tile, and chrome.



CAT. NO.	CONTENTS	QTY/CASE
SW841	15 Oz. (425 g)	12

CRL Sprayway Auto Care Instant Shine

- Get a Beautifully Renewed Surface from an Aerosol Can
- Great for Weatherstrips, Body Moldings, and Other Rubber and Plastic Items

CRL Sprayway Auto Care Instant Shine is a great final detail product. Use it on tires, vinyl interiors, bumpers, bumper guards, body moldings, door jambs, engine compartments, even those hard to reach air conditioner ducts. For best results just spray on and buff, or let dry to a "like new" shine.



CAT. NO.	CONTENTS	QTY/CASE
SW936	11 Oz. (312 g)	12

CRL Motsenbocker's Lift Off Removers

- Stain Removal Made Easy with Three Specialized Formulas for the Toughest Stains
- Excellent Results on the Job, in the Shop, or in the Home

Lift Off 2 for Grease, Oils, and Adhesives

Lift Off 2 is a Petroleum-based, commercially proven formula that effectively removes such items as adhesives, grease, tar, motor oil, gum, sap, and oil-based foods. Pistol grip bottles are attractive for over-the-counter sales.



CAT. NO.	CONTENTS
LF2	22 Fl. Oz. (650 ml)

Lift Off 3 for Pen, Ink, and Marker Graffiti

Lift Off 3 is a biodegradable, water-based product designed to remove most inks including: permanent markers, indelible inks, ball point pens, highlighters, stamp pad and fountain inks. Pistol grip bottles are attractive for over-the-counter sales.



CAT. NO.	CONTENTS
LF3	22 Fl. Oz. (650 ml)

Lift Off 4 for Spray Paint Graffiti

Lift Off 4 is the first biodegradable, water-based spray paint graffiti remover. It actually breaks the molecular bond between the paint and hard, soft or porous surfaces without damaging them. Pistol grip bottles are attractive for over-the-counter sales.



CAT. NO.	CONTENTS
LF4	22 Fl. Oz. (650 ml)



CRL Wipes In A Bucket

- Quickly Removes Urethane, Tough Soils, Adhesives, Grease, Etc.
- No Rinsing, No Drying, No Residue
- Effective, Portable and Convenient

CRL99W Wipes in a Bucket are a patented, waterless hand cleaning system combining both a high quality liquid hand cleaner formula, and a heavy-duty, non-scratching, abrasive hand-cleaning towel. Unique patented towel construction is comprised of a polymeric non-woven soft layer, to which thousands of polymeric deep cleaning scrubbers are permanently bonded to one side of the surface. Then, a special micro-perforation pattern is added to hold effective yet mild liquid contaminate-dissolving agents and soil lifters that dry quickly after use. Use Wipes in a Bucket to clean up spills, drips, and spatters from most non-porous surfaces like shop tools, equipment, counter tops, and more. Large 10-1/2" by 12-1/4" (26.7 by 31 cm) wipes dispense easily from their own pop-up container.



Optional Wall Mount Bracket keeps Wipes in a Bucket handy, and frees-up space on your work bench.

CAT. NO.	DESCRIPTION	QTY/CASE
CRL99W	Bucket of 72 Wipes	6
CRL99WB	Optional Wall Mount Bracket	-



CRL Scrubs™-In-A-Bucket

- Pop-Up Towels Impregnated with Waterless Hand Cleaner
- Cleans Urethane, Adhesives, Grease, Oil, Inks, Tar, and More
- Recyclable and U.S.D.A. Authorized

Use CRL Scrubs™-in-a-Bucket for fast and easy hand cleaning. These pre-moistened towels clean hands of urethane, adhesive, ink, tar, and oil with a gentle-to-the-skin formula that gives pumice performance without the grit. Natural citrus fragrance.

CRL Scrubs™-in-a-Bucket contain a germ fighter, and leave hands clean without residue or drying. Also great for cleaning tools, work surfaces, and spills. Plus, they're recyclable, U.S.D.A. authorized, and carry an E-4 rating. Large 10-1/2" by 12-1/4" (26.7 by 31 cm) wipes dispense easily from their own pop-up bucket.

CAT. NO.	DESCRIPTION	QTY/CASE
C422	Bucket of 72 Wipes	6



CRL Kimberly-Clark® Sani-Tuff® Waterless Hand Wipes

- Grit Cleaning Power Without the Abrasion
- No Harsh Solvents
- Effective, Portable, and Convenient

These CRL Kimberly-Clark® Sani-Tuff® Waterless Hand Wipes are a patented waterless hand cleaning system which combine both a high quality liquid hand cleaner formula, and a heavy-duty, non-scratching, abrasive hand-cleaning towel all into one. Sani-Tuff® Waterless Hand Wipes have the formulation that's right for your workplace. These wipes handle the toughest cleanups including urethanes, paint, tar, and everyday soils without harsh solvents. Can also be used to clean up spills, drips, and spatters from most non-porous surfaces like shop tools, equipment, counter tops, and more. On the job, on the go, however your hands get grimy, these towels will get them clean. Each pop-up dispenser tub contains 90 fast cleaning wipes measuring 12" by 12" (30.5 by 30.5 cm).

CAT. NO.	DESCRIPTION	QTY/CASE
K91341	Tub of 90 Wipes	6



LOG ON TO crlaurence.com FOR BUSINESS-TO-BUSINESS SERVICES

A156 | PHONE (800) 421-6144 | FAX (800) 262-3299 TOLL FREE FROM ANYWHERE IN THE U.S.A. OR CANADA

CRL Hand Cleaner

- 100% Organic Formula is Safe for Skin
- Cleans Dried Urethane and Other Tough Stains such as Grease, Oil, Ink, and Carbon Smudges
- Also an Excellent Lubricant for Rubber Gasket and Glass Installations

CRL Hand Cleaner has a 100 percent organic formula that dissolves grease, oil, ink, carbon smudges, dried urethane, and other sealants. It cleans urethane stains from auto glass, paint, and vinyl upholstery. It is also excellent as a lubricant for rubber gasket and glass installation. It contains absolutely no petroleum products that will be harmful to your skin, and has lanolin to condition your skin. Non-polluting, non-toxic, non-caustic, non-irritating, non-flammable, water soluble, completely organic and biodegradable. It has an unlimited shelf life if kept closed between uses. The pleasant citrus scent leaves a clean smell.



CAT. NO. HC45
4.5 Oz. Tube



CAT. NO. HC140
14 Oz. Tub



CAT. NO. HC720
4.5 Lb. Tub

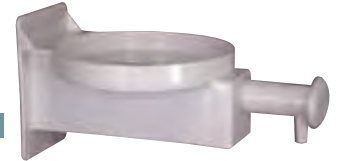

CAT. NO. HC2145
Dispenser for HC720



CAT. NO.	CONTENTS	QTY/CASE
HC45	4.5 Oz. (128 g) Tube	12
HC140	14 Oz. (397 g) Tub	12
HC720	4.5 Lb. (2.14 kg) Tub	6
HC2145	Dispenser for HC720 Can	1

CRL Kimberly-Clark® Kimcare NTO Hand Cleaner with Grit

- Works Effectively, Even Without Water
- Formulated for Tougher Grime

CRL Kimberly-Clark® Kimcare NTO Hand Cleaner with Grit is designed to remove tougher hand soil without water. It contains polymer beads for scrubbing without the abrasion associated with other grits using pumice or walnut shells. Each rugged one gallon container comes with its own dispensing pump.



CAT. NO.	CONTENTS
K91035GL	1 Gallon (3.785 l)



CRL Rez-Guard Barrier Cream

- Helps Protect Hands Against Problems Associated with the Handling of Industrial Adhesives, Solvents, Sealants, and Coatings

CRL Rez-Guard Barrier Cream helps protect hands against dermatitis, skin irritation, dryness, and cracking. Prevents fingers from sticking together when using cyanoacrylates (super glue). Rez-Guard contains glycerine to promote healing, but contains no silicone, so it's clean and washes off with water.



CAT. NO.	CONTENTS	QTY/CASE
REZ4	4 Fl. Oz. (118 ml)	24



CRL Grime Scrub Brush

- Gentle and Effective Cleaning Action Quickly Removes Grime
- Special Row of Stiff Bristles Cleans Under Fingernails
- Contoured Handle for Firm Gripping
- Bristles Molded Firmly in Place
- Use in the Shop or at Home
- Durable and Lightweight



CAT. NO. 17050

The CRL Grime Scrub Brush effectively cleans out the grime from the crevices in one's hand, and has a special row of bristles to clean under fingernails. The contoured handle gives even wet hands a firm grip. Durable and lightweight, with molded-in-place bristles for long service life.



new

CRL Lint Free Glass Wipes

- New, Convenient Pop-Up Dispenser Box
- Strong, Four-Ply White Paper Wipes are Virtually Lint Free
- Reinforced Nylon Scrim in Both Directions So They Work Great Wet or Dry



- Six Pop-Up Boxes in Each Case

Extra-tough CRL Lint Free Glass Wipes bring the absorbing power you need in a lighter weight material that's reinforced with a nylon scrim for extra strength. The ripple texture makes them easy to hold during use, and provides just the right amount of surface area for cleaning solutions to do their work.

CRL Lint Free Glass Wipes have no adhesives or binders so they leave nothing behind except clean, lint free surfaces. Besides glass, they are ideal for your most demanding shop clean up tasks.

CRL Lint Free Glass Wipes measure a big 16-1/2" by 9-3/4" (42 by 25 cm). Each case has six pop-up boxes containing 150 wipes each for a total of 900 wipes per case.

CAT. NO.	DESCRIPTION
1550	Case of 900 Wipes
BX15	Box of 150 Wipes

CRL Lint Free Glass Wipes Dispenser Bracket

- Positions Pop-Up Boxes of 1550 and BX15 Wipes Right Where You Need Them

Mount the K73900 Dispenser Bracket to walls or work benches for quick and easy pull-down dispensing of our 1550 and BX15 Lint Free Glass Wipes. Mounting screws, wall anchors, and double face tape patches are included. After attaching the bracket, simply press the perforated edge of the Wipe box against the two forks to mount.



CAT. NO. K73900

CRL Paper Towels in Rolls

- Strong and Extra Absorbent
- Two Plies Thick



Roll Holder
* Roll of paper towels not included

CRL Paper Towels are two plies of strong white paper with extra absorbent qualities. Each big 11" by 11" (28 by 28 cm) sheet wipes up spills quickly, and you get 90 big sheets per roll. You'll find CRL Paper Towels economical to use. They're great on the job, in the shop, and around the house. Sold only in cases of 30 rolls. Each roll has 90 towels, and each roll is individually wrapped. Wall mounted Paper Towel Roll Holder available separately.

CAT. NO.	DESCRIPTION
148L	Case of 30 Rolls of Towels
148D	Paper Towel Roll Holder

CRL Micro Fiber Wipes new

- Streak Free Cleaning on Windows and Mirrors
- Washable Up to 500 Times



CRL Micro Fiber Wipes have thousands of microscopic fibers that trap dirt and grime to increase cleaning effectiveness and reduce cleaning and drying times. Our large 16" by 16" (40.6 by 40.6 cm) size takes on big polishing, waxing, cleaning, and dusting jobs, and when you're done you can simply machine wash them (without fabric softener). Packed two per poly bag with a hanger hook so you can also offer them for resale to your customers.

CAT. NO.	DESCRIPTION	QTY/PACK
MFW2	Micro Fiber Wipes	2



CRL Kimberly-Clark® WypAll® Workhorse® X80 Shop Towels

- High Tech Performance at a Value Price
- Made with Hydroknit® Fast Absorbing Material

CRL Kimberly-Clark® WypAll® Workhorse® X80 Shop Towels are engineered to feel like cloth and work even better. They are made with patented Hydroknit® Fast Absorbing Material that has outstanding tear resistance and exceptionally high performance on tough tasks. Absorbs water and oil faster pound for pound than laundered shop towels, with no holes, strings, metal chips or residue to worry about. Sold in cases containing five pop-up boxes of 80 white towels for convenient dispensing. Minimum order is one case. Towels measure 9-1/8" by 16-3/4" (231 by 425 mm).



CAT. NO.	DESCRIPTION	QTY/CASE
K41048	Workhorse® X80 Towels	5 Boxes

CRL Kimberly-Clark® WypAll® Workhorse® X70 Manufactured Rags

- High Tech Performance at a Value Price
- Made with Hydroknit® Fast Absorbing Material

These big rolls of CRL Kimberly-Clark® WypAll® Workhorse® X70 Manufactured Rags will give you long lasting performance for extended usage and minimal waste. These rags have what it takes to tackle those heavy-duty industrial jobs usually handled by cloth rags. Packed three rolls per case. Each roll contains 275 10" by 13-3/8" (254 by 340 mm) manufactured rags. Minimum order is one case.

The K09025 Center Pull Dispenser is available for fast delivery of Workhorse® X70 Manufactured Rags, and can be mounted permanently or temporarily with the included hardware.



CAT. NO.	DESCRIPTION	QTY/CASE
K41702	Workhorse® X70 Manufactured Rags	3 Rolls
K09025	Center Pull Dispenser	1

CRL A-Tork® Maxi Wipes

- Super Absorbent 2-Ply Rolls Will Not Deteriorate in Water

CRL A-Tork® Maxi Wipes are the latest addition to the CRL Professional Glass Cleaning System. These 100% cellulose wipes measure 15-1/8" by 12-1/2" (384 by 317 mm), and are able to absorb up to four times their own weight in liquids, requiring fewer wipes per job. They will not deteriorate in water, solvent or detergent, making them ideal for use with CRL Professional Water Spot Remover and other cleaners. If you're making insulating glass units, they'll leave your glass lint and streak-free every time. The big 735 sheet roll can be kept clean and contamination-free by using the sealed, consumption control Center Pull Dispenser.

CAT. NO.	DESCRIPTION	QTY/CASE
0101311	Single Sheet Maxi-Wipes Rolls	2 Rolls
0101353	Center Pull Dispenser	1 Each



Center Pull Dispenser

CRL Kimtowels

- Tough, Strong Multiple Plies
- Highly Absorbent
- Durable and Reusable



Get maximum wiping performance with minimum smudging, smearing, and streaking. These CRL Kimtowels have multiple plies bonded together to form a tough, durable wiper for hands and equipment. Extra absorbent inner plies soak up oil, water, and solvents fast. Kimtowels will clean up more and last longer than ordinary paper towels, and they cost less to use. Kimtowels measure a big 12.5" by 14" (317 by 355 mm).

CAT. NO.	TOWELS/PACK	TOWELS/CASE
K47011	68	816

CRL Kimtex Shop Towels

- Super Absorbent, Remarkably Soft
- Poly Fiber Towels are More Durable than Paper



These remarkably soft and super absorbent CRL Kimtex Shop Towels are made in a special, patented process using meltblown polypropylene fibers to create the first non-woven wiper durable enough to replace shop rags. A low-lint wiper with the soft texture of cloth and the economical disposability of paper towels, Kimtex Towels are more durable than paper and outlast disposable towels. Towels measure 12" by 14" (305 by 355 mm).

NOTE: Kimtex Towels are made with a special process that contains harmless chemicals that may leave a film if used to clean glass. For cleaning glass, we suggest you use CRL 1550 Lint Free Glass Wipes.

CAT. NO.	SHEETS/PACK	SHEETS/CASE
33560	66	528

CRL Pro-2 Silicone Spray

- Our Best Selling Lube
- Seals Out Moisture
- Waterproofs and Lubricates

Use our versatile CRL Silicone Spray for just about any lubricating need. An effective squeak squelcher, its non-conducting, non-gumming formula repels water. Use it to damp-proof auto and marine electrical systems, and for many other applications.



CAT. NO.	CONTENTS	QTY/CASE
PR02	10.75 Oz. (305 g)	12

Minimum Order is One Can.



CRL Metal Lube

- Extremely Versatile Lube that Cleans as it Lubricates
- Preserves Metal Finish from Rust and Corrosion
- Frees Sticky Hinges, Rollers, Guides and Other Tool Parts

Developed for the professional to handle all metal lubricating needs, CRL Metal Lube unsticks hinges, latches, locks, and rollers. It can also be used on power tools, saws, trunk lids, and car door hinges. Preserves metal from rust and corrosion.



CAT. NO.	CONTENTS	QTY/CASE
1200	11 Oz. (312 g)	12

Minimum Order is One Can.



CRL White Grease Lubricant

- Excellent for Metal-to-Metal Moving Parts
- Heavy-Bodied Spray Lube

CRL White Grease Lubricant is a heavy-bodied aerosol spray lube that frees metal moving parts in locks, gears, chains, cables, pulleys and more. Clings to sprayed areas to give good lubricating performance and keep things working right.



CAT. NO.	CONTENTS	QTY/CASE
CRL715	11 Oz. (312 g)	12

Minimum Order is One Can.



CRL Spray Penetrant and Corrosion Preventer

- Penetrates Fast to Unstick Frozen Nuts, Bolts and Machine Parts

CRL Penetrating Oil works fast to unstick frozen parts. It lubricates parts and displaces moisture. An excellent corrosion preventative for tool and die steels and tool room equipment. Can be totally removed if necessary, using common petroleum-based solvents.



CAT. NO.	CONTENTS	QTY/CASE
CRL960	13 Oz. (369 g)	12

Minimum Order is One Can.



CRL WD-40 Lubricant

- Heavy-Bodied Spray Lube Clings to Sprayed Areas Giving Good Lubricating Performance
- Penetrates and Loosens Frozen Nuts, Bolts, Etc.
- Three Convenient Sizes

One of the most popular lubricants used in home, auto and industrial applications. WD-40 lubricates and leaves an invisible film of protection against rust and corrosion. It penetrates to free frozen nuts, bolts and more. It's clear, clean, and non-staining.

CAT. NO.	CONTENTS	QTY/CASE
WD40	8 Oz. Aerosol	12
WD4018	16 Oz. Aerosol	12
WD401	1 Gallon	4

Minimum Order is One Can.



CAT. NO. WD40
8 Oz. (226 g)

CAT. NO. WD4018
16 Oz. (453 g)

CAT. NO. WD401
1 Gallon (3.785 L)



CRL Polishing Oil

- Spray On Belts and Discs for Faster, Brighter Polishing
- Promotes Longer Belt Life

Spray CRL Polishing Oil on your abrasive belts and discs to keep them soft and free cutting. Helps to reduce "loading" while it improves finish edges on metal and glass. Spray directly on belt or abrasive wheel before starting, then re-apply lightly as needed. Gives you longer belt life and a brighter, faster polish.



CAT. NO.	CONTENTS	QTY/CASE
CRL920	11 Oz. (312 g)	12

Minimum Order is One Can.



CRL Sprayway Dry Silicone Lubricant and Release Agent

- Lubricates Dry Without Picking Up Debris
- Excellent for Sliders and Window Channels

CRL Sprayway Dry Lubricant and Release Agent lubricates window channels, doors, weatherstripping, trunk seals, car seat adjustment mechanisms and more. It also acts like a release agent for plastic moldings. Use it to waterproof ignition system hinges, springs and casters, or to eliminate squeaks from fan belts.



CAT. NO.	CONTENTS	QTY/CASE
SW77	12 Oz. (340 g)	12

Minimum Order is One Can.



CRL 3M™ Silicone Lubricant

- Dry Type
- Seals Out Moisture
- Prevents Squeaks and Sticking

CRL 3M™ Silicone Spray Lubricant seals out moisture from a vehicle's distributor, ignition, spark plugs, and all auto electrical wiring. It eliminates the squeaks and sticking caused by friction between moving parts, and fights corrosion on metals. You can also use it to preserve leather and rubber.



CAT. NO.	CONTENTS	QTY/CASE
3M8897	8 Oz. (228 g)	12

Minimum Order is One Can.



CRL 3M™ Silicone Lubricant Plus

- Wet Type
- Seals Out Moisture
- Prevents Sticking

CRL 3M™ Silicone Spray Lubricant is designed to aid in the installation of rubber gasket-set windshields and backlights. Seals out moisture from a vehicle's distributor, ignition, spark plugs, and all auto electrical wiring. May also be applied to metal, glass, vinyl, wood, and painted surfaces.



CAT. NO.	CONTENTS	QTY/CASE
3M8877	9 Oz. (255 g)	12

Minimum Order is One Can.



CRL Can Organizer

- Keeps Loose Cans Organized in Vehicles
- Aluminum Bracket for Easy Mounting
- Design Allows Visibility of Cans in Holder

new

The CRL Can Organizer is a great way to organize loose cans, and keep them from rolling around in your vehicle. Use it for your aerosol lubricants, coatings, or cleaners. The special design of the Can Organizer allows the labels of each can to be easily visible for quick identification of what you need in an instant. Sturdy aluminum bracket makes mounting a breeze.



CAT. NO. RX1394



CRL Glas-Slip

- Rubber Lubricant for Easier Installation of Gaskets
- Helps with Installation and Centering of Gasket Set Glass

CRL Glas-Slip is a specially formulated lubricant that makes working with glass and rubber gaskets easy. It's extra slippery and stays wet, so you can spread it on the entire gasket before you install the glass. Also makes the installation of filler strips quick and easy. Apply it with a brush or rag, or spread it on with your fingers. Glas-Slip comes in one gallon cans or handy quart size cans.



CAT. NO. GS32
Quart Can



CAT. NO. GS128
Gallon Can



CAT. NO.	CONTENTS	QTY/CASE
GS32	32 Oz. (.945 l)	12
GS128	128 Fl. Oz. (3.785 l)	4

CRL Krytox High-Performance Lubricant

- Excellent for Stopping Persistent Squeaks in Automobiles, Machinery, Fixtures or Tools
- Insoluble in Common Solvents
- High Temperature Stability Up to 650°F (344°C)

CRL Krytox High Performance Lubricant is excellent for windshield molding and interior trim squeaks, and is compatible with plastics, rubber, ceramics, and metals. Krytox Lubricant is also ideal for use on machinery, tools, bearings, or virtually any area where lubrication is required. Since GPL205 Lubricant is fluorinated, it can be used around chemicals, and is non-flammable. It is safe to work with in almost any application.



CAT. NO.	CONTENTS	QTY/CASE
GPL205	1/2 Fl. Oz. (14.7 ml)	12

CRL Dry Graphite

- Greaseless and Dripless
- Highly Refined Fine Powder

CRL Dry Graphite is highly refined into a finely powdered texture which provides superior dry lubrication. Use to unstick locks, doors and windows; or to keep tools working easily. The puffer bottle is refillable from the 1/2 pound bulk bottle.



CAT. NO. MZ25
1/2 Pound (226 g)
Bulk Bottle



CAT. NO. MZ21
1.76 Ounce (50 g)
Puffer Bottle

CRL Pistol Type Oiler Can

- Made Especially for Dispensing Oil and Solvents
- Rust and Corrosion Proof

This light duty, high density polyethylene CRL Pistol Type Oiler dispenses oil and solvents through a 6" (152 mm) rigid spout. Six fluid ounce (177 milliliter) capacity. Wide molded base helps keep it from tipping on your work bench.



CAT. NO. KP500



CRL Tube Wax Lubricant

- Increases Production and Improves Tool Life
- Excellent for Use with CRL Sanding Belts and Discs
- Reduces Screw Breakage and Speeds the Installation by Lubricating the Threads



A special formulation of solid waxes that comes in a convenient, soft stick. Use it for all sawing, grinding, drilling, tapping, sanding, and fastening operations to increase production quality and improve tool life. Neat and easy to handle, requiring no special storage or handling.

CAT. NO.	CONTENTS	QTY/CASE
WS140	15 Oz. (425 g)	24

CRL Grease Stick

- General Purpose Lubricant for All Kinds of Metal Working
- Reduces Blade Wear, Increases Tool Life



A high quality, general purpose lubricant, the CRL Grease Stick is useful for many shop or on-the-job purposes. It can reduce wear on blades, drills, taps, and cutters, giving longer life because you do not need to sharpen them as often. Use on screw threads for easier driving. Comes in a large, easy to apply fiber tube.

CAT. NO.	CONTENTS	QTY/CASE
GS29	24 Oz. (680 g)	24

CRL Lith-Ease White Lithium Grease

- Long Lasting Lubricant with Many Automotive, Marine, and Shop Uses
- Excellent Water and Heat Resistance



The CRL Lith-Ease Grease Cartridge is a high quality, multi-purpose white lithium grease for automotive, marine, shop, and farm use. It is a long lasting lubricant with excellent resistance to heat and water. Lith-Ease provides superior performance in all weather and all temperatures. Cartridge fits our Cat. No. C1080 Grease Gun.

CAT. NO.	CONTENTS	QTY/CASE
WL14	14.5 Oz. (411 g)	10

CRL Grease Gun

- Uses Standard 14 Ounce Grease Cartridges
- Also Dispenses Bulk Loaded Grease



CAT. NO. C1080

The CRL Grease Gun is a precision-made, heavy-duty constructed gun built to give years of service under rugged conditions. It is designed for use with grease cartridges, such as our Cat. No. WL14, and also for bulk loading. The plunger lock makes it easier to load

and bleed, and the head cap vent quickly releases trapped air. A safety lock cap prevents accidental plunger release while loading. It is well balanced for easy handling, with a non-slip, knurled grip barrel. The baked enamel finish is easy to keep clean.

CRL WEB SITE INFORMATION

Finding What You Want is Quick and Easy When You Use Our A to Z Product Index at crlaurence.com

First log on to crlaurence.com and Click on A to Z Product Index.



Click on the first letter of the product you are looking for.

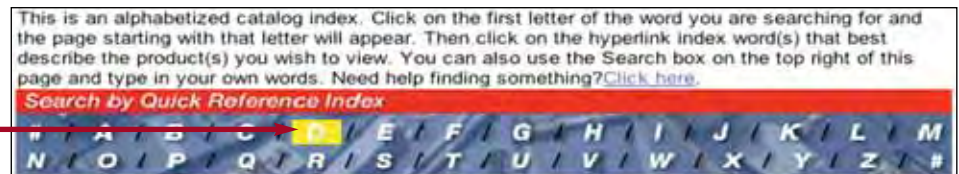

Click on the name of the product you are looking for. You'll get a list of colors, sizes or types of the product.



Click on the one you want. The product's Offer Page will appear with full information and prices for the product.



Short Cut:
Enter the Product's Catalog Number in the Product Search Here Box and Click Go. You'll go directly to the product's Offer Page!



LOG ON TO crlaurence.com FOR BUSINESS-TO-BUSINESS SERVICES

A164 | PHONE (800) 421-6144 | FAX (800) 262-3299 TOLL FREE FROM ANYWHERE IN THE U.S.A. OR CANADA

CRL Automotive Tools and Supplies

- Professional Quality
- Brand Names
- Constant Improvement
- The Industry's Largest Distribution Network

CRL maintains the industry's largest supply of tools, equipment and supplies for the automotive glass replacement market. Everything you need to successfully operate a shop and provide quality service to your customers by using the most professional tools available.

Our commitment to providing these products is evident in the quality and thoroughness of our product lines. CRL stocks the major brand name tools you will recognize as the finest available, known for their durability and value.

CRL is constantly searching for new and improved automotive tools. We encourage inventors to present their new tool ideas for incorporation into the CRL family of tools. CRL has an attractive royalty program for ideas that become reality.



CRL is Interested in Your Inventions

- Fast Track Your Idea
- Full Confidentiality

Every day someone finds a better way or better tools that will make our work either easier or faster. If you have an idea that you would like marketed contact CRL for assistance with making your idea a reality. CRL has hundreds of products that were once someone's idea, and now they are shown in one of CRL's catalogs and on our web site. We get thousands of hits per day on our web site, and you can tap into this market with your idea.

You can't go wrong bringing your idea to the industry leader. Expect full confidentiality with our Product Management Department. We work with inventors every day, and all communications and product information is kept in strict confidence.

For further information, please contact CRL Corporate Headquarters at (800) 421-6144 in the U.S., or (877) 421-6144 from Canada, and ask for the CRL Product Manager at Extension 5440. You can also e-mail the Product Manager at prodman@crlaurence.com.



Continuing Auto Glass Education

• Education

A true professional is a person who continues to improve themselves within their profession. This is not on-the-job training, but being part of a structured class organized for your industry. There are many ways to continue to improve your ability to perform your work according to industry standards. Schools, such as the National Glass Association's Auto Glass Technical Institute provide this education.

• Standards

Becoming an ANSI-AGRSS registered shop demonstrates to your customers that you will perform your work according to a recognized industry standard. Following this standard ensures that your shop will use the correct materials in the correct manner in performing repair service for your customers.



National Glass Association Auto Glass Technical Institute



This program is taught by some of the industry's most knowledgeable individuals, and provides the basics for professional and safe auto glass replacement. They teach everything from using a NAGS® book and calculator, to the proper technique in power tool use. Most classes are held at regional vocational schools. Check the NGA web site www.glass.org to view school locations, dates, and times.

ANSI-AGRSS Standards



The new ANSI-AGRSS Standard was created "to develop and publish nationally recognized automotive glass replacement safety standards addressing procedures, education, and product performance." This new standard was produced by installers, glass producers, car manufacturers, trade magazine publishers, and industry trade association representatives. They created a registration program for glass shops to become a registered ANSI-AGRSS shop. CRL supports the efforts of the AGRSS Standards, and suggests you do too. Join with CRL and support this effort. You can register online at www.agrss.com.

Auto Glass Associations



C.R. Laurence Company is proud to be a member of these fine automotive associations, and encourages all Auto Glass Replacement professionals to contact them to see the benefits of their memberships. Keeping in touch with our ever-changing industry is much easier when you are consistently informed through these organizations.

Auto Glass Publications



Stay informed of all the latest repair procedures, tools, and supplies of your trade by subscribing to these industry specific magazines. Auto glass installation and repair methods by industry experts help to keep you current and informed.



LOG ON TO crlaurence.com FOR BUSINESS-TO-BUSINESS SERVICES

A166 | PHONE (800) 421-6144 | FAX (800) 262-3299 TOLL FREE FROM ANYWHERE IN THE U.S.A. OR CANADA

CRL Auto Glass Technician's Starter Kit

new

- Outfit a New Employee
- Spare Tools for Mobile Unit

The CRL Auto Glass Technician's Starter Kit provides the beginning technician with a good selection of tools to help get started in the trade. We provide basic tools to keep your cost low, and allow the new technician to grow into the tools that will be required as their knowledge and experience grows. This kit lets the technician tackle just about any job they would normally be assigned. The basic tool groups have been selected for windshield, back glass, and door glass removal, replacement and clean up, including safety gear. Start your new employee off on the right foot with this professionally prepared kit.



CAT. NO. TSK01

THE KIT CONTAINS ONE EACH OF THE FOLLOWING TOOLS AND SUPPLIES:

CAT. NO.	DESCRIPTION
RK160	Standard Cold Knife
AN1001	3/4" Ultra Thin Cold Knife Blade
AN1002	1" Ultra Thin Cold Knife Blade
AN1004	1-1/2" Ultra Thin Cold Knife Blade
PK19	Pipe Handle Long Knife
77K	Quick Blade Utility Knife
1993X10	Pack of 10 Extra Long Utility Knife Blades
1996X10	Pack of 10 Molding Removal Hook Blades
21510T	10 in 1 Trim Tool
L47000	Filler Strip Tool
CRL761	Razor Blade Scraper
4050	Scrape and Pry Bar
TW72	Roll of Cut-Out Wire
LWH200	Pair of Cut-Out Wire Handles
ES384	Safety Glasses
GR1PL	Pair of GripPro Impact Gloves

CAT. NO.	DESCRIPTION
CRL69	Auto Vacuum Cup
CP253	Hook Tool
RT752	Rope-In Slider Tool
CRL216	Beveled Windshield Stick
CRL220	Chisel Tip Windshield Stick
CRL216H	Windshield Stick Handle
CP26	Door Handle Tool
KD485	Pinch Weld Scraper
WG41004XT	18 to 1 High Ratio Caulking Gun
MR215	Molding Removal Tool
MB2	5/64" and 3/32" Hex End Mirror Tool
MB2TX	T15 and T20 Torx End Mirror Tool
MB3	Ford Mirror Release Tool
MB4	Chevy/GM Mirror Release Tool
15561	27 Piece Driver Set
180312	Tool Box w/Tray

CRL Pocket Ref

new

- Tool and Construction Specs; Info on Paints, Finishes and Adhesives; Metric Conversions; and Lots of Useful Information



CAT. NO. REF01

The CRL Pocket Ref is a wealth of information. Use it for tool and construction specs; get info on paints, adhesives and finishes; convert metric measurements; get electrical ratings and equivalents; solve math, geometry, and chemistry problems; look up area codes. It's even got a 12 year perpetual calendar! There's a ton of useful data in this over 500 page reference that fits on your desk or in your glove compartment. Hours of informative and entertaining reading.

CRL NAGS® Air Bag Quick Reference Guide

new

- Information on Safely Disabling or Activating Air Bags



CAT. NO. NAGS04

The NAGS® Air Bag Quick Reference Guide provides you with the information you need to safely disable or activate an air bag system for auto glass replacement. The inherent danger surrounding these devices makes this publication a "must have" tool for your shop and your employees. Complete information on locations of sensors, bags, and control module components is fully illustrated in this book.



CRL Standard Cold Knife

- Our Best Selling Removal Tool
- Uses All CRL Cold Knife Blades



CAT. NO. RK160

The CRL Standard Cold Knife comes complete with a strong tempered steel blade sharpened to a fine cutting edge. Large durable aluminum handle, combined with a steel cable pull handle assures the easiest and fastest way of cutting the adhesive around the windshield. Comes with one Cat. No. RKB141 Standard Blade.

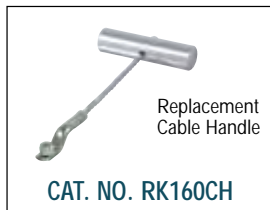

CRL Foam Grip Push Button Cold Knife

- Push Button Blade Change
- Foam Grip Handle
- Uses All 3/4" Shank CRL Cold Knife Blades



CAT. NO. RK500

Our CRL Foam Grip Push Button Cold Knife has a convenient one step push button blade release system. The blue textured foam grip adds handling stability, gripping action, and user comfort. Comes with one Cat. No. RKB10 Stainless Steel Cutting Blade.

Note: All CRL Cold Knife Blades fit the handles shown on this page. See pages A169 to A171 for blades.

CRL Short Handle Cold Knife

- Perfect for Tight Areas
- Uses All CRL Cold Knife Blades



CAT. NO. RK160S

The CRL Short Handle Cold Knife was designed for use on vehicles where the hood or fender comes up over the bottom edge of the windshield and rides so close that it is very difficult to get a cold knife under the hood to cut the urethane. Also useful on vans and RV's where the roof overhangs the top of the windshield. Comes with one Cat. No. RKB141 Standard Blade.

CRL Contoured Grip Push Button Cold Knife

- Push Button Blade Change
- Ergonomic Handle Design
- Uses All 3/4" Shank CRL Cold Knife Blades



CAT. NO. RZ500

This CRL Contoured Grip Push Button Cold Knife features a quick and easy one step push button blade release system. The ergonomic design of the contoured handle improves stability, gripping action, and user comfort. Comes with one Cat. No. RCB175 Cobra Cutting Blade.

CRL Contoured Grip Push Button Cold Knife Kit with 18 Blades



CAT. NO. RZ5K1T

This CRL Push Button Cold Knife Kit provides you with the newest in cold knife design and innovation. You also get six each of these UltraWiz Ultra Thin Cold Knife Blades: AN5001 3/4" (19 mm), AN5002 1" (25 mm), and AN5004 1-1/2" (38 mm) lengths.

CRL Standard Cold Knife Blades

- One of Our Best Sellers
- Fits All 1/2" Shank Handles



These CRL Standard Cold Knife Blades are made of tempered steel for extra strength. The 7/8" size is our biggest seller. Please note these blades have 1/2" wide shanks.

CAT. NO.	BLADE LENGTH (L)
RKB141	7/8" (22 mm)
RKB146	3/8" (6 mm)

CRL Stainless Steel Cold Knife Blades

- Super Strong
- Use with All Handles



Our CRL Stainless Steel Blades are super strong for extended use life. They fit standard cold knives, and have tips that can be re-sharpened. Three different tip lengths cover a variety of cut-out applications.

CAT. NO.	BLADE LENGTH (L)
RKB75	3/4" (19 mm)
RKB10	1" (25 mm)
RKB15	1-1/2" (37 mm)

CRL Long Shank Stainless Steel Cold Knife Blades

- Gives Additional Clearance
- Use with All Handles



These CRL Long Shank Stainless Steel Blades provide good distance from the body during the cut-out. The two tip lengths give you the versatility to change to a longer length to cut wider beads of urethane along the bottom of the glass.

CAT. NO.	BLADE LENGTH (L)
RKB410	1" (25 mm)
RKB415	1-1/2" (37 mm)

CRL Coated Cold Knife Blades

- Less Drag for Smoother Cutting
- Fits All 1/2" Shank Handles

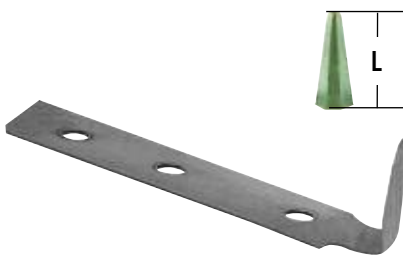

CRL Coated Cold Knife Blades are specially sharpened, then coated to produce a blade that is unsurpassed in performance when cutting through tough urethane. These blades have 1/2" wide shanks.

CAT. NO.	BLADE LENGTH (L)
RKB142	1-3/8" (30 mm)
RKB143	7/8" (22 mm)

CRL Cobra Stainless Steel Cold Knife Blades

- Unique Rounded Grind Produces Less Drag
- Use with All Handles



CRL Cobra Stainless Steel Cold Knife Blades remain flexible, stay sharp and last longer. The rounded blade face provides less flat surface for the adhesives to stick to during cut-out. This unique blade dimension has been proven to cut with better performance than other blades available.

CAT. NO.	BLADE LENGTH (L)
RCB175SS	3/4" (19 mm)
RCB110SS	1" (25 mm)

CRL995 Knife Replacement Blade

- Narrow Width Blade for CRL995 Handle Only



Made with a 1/2" wide shank, the CRL995B Blade will only fit our CRL995 Cold Knife Handle. Many of our customers have used the CRL995 Knife for years, and only CRL offers this specially designed blade.

CAT. NO.	BLADE LENGTH (L)
CRL995B	3/4" (19 mm)

CRL PowerPull™

- Adds 25 Inches of Extra Length to Your Cold Knife
- Maintains Correct Cutting Angles
- Handle Provides Two-Handed Pulling

new

This all new CRL PowerPull™ sets up quickly so you can easily cut windshields that don't normally allow you to start the cold knife at the top. The handle controls the cutting angle, and even lets you use both hands for additional pulling power. For best results use with our Cat. No. RK160 Cold Knife (see page A168). Comes with complete instructions.

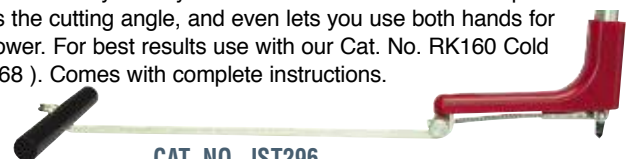

CAT. NO. JST296

CRL UltraWiz Cold Knife

- Ergonomic Contoured Handle with Cable Pull for Extra Power
- Uses All 3/4" Shank CRL Blades



CAT. NO. AN3001K

The UltraWiz Short Handle Cold Knife is the perfect choice to accompany UltraWiz Blades. All UltraWiz Handles are shaped for comfort and gripping power, and have a single set screw that allows for quick blade changes. This knife comes with one Cat. No. AN1001 Standard Blade.

CRL UltraWiz Short and Long Cold Knives

- Contoured Extruded Handle
- Quick Change Single Set Screw
- Uses All 3/4" Shank CRL Blades

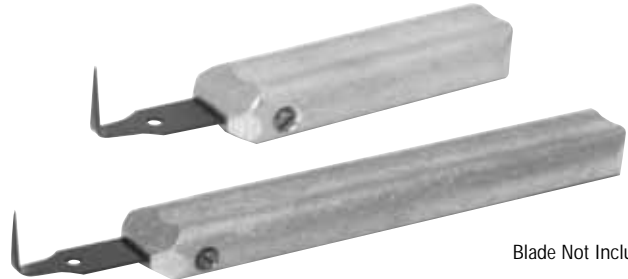

Blade Not Included

These UltraWiz Short and Long Cold Knife Handles provide the extra reach and power required to cut urethane. UltraWiz Handles are shaped for comfort and gripping power. Both handles feature a single set screw for quick blade changes. Blades must be ordered separately.

CAT. NO.	DESCRIPTION
AN2001M	4-3/4" (121 mm) Short Handle
AN2002M	8-3/4" (222 mm) Long Handle

CRL UltraWiz Lever Action Cold Knife

- Flip Lever to Adjust Blade Length
- Uses All 3/4" Shank CRL Blades



new

CAT. NO. AN3007K

The UltraWiz Lever Action Cold Knife provides the extra power and adjustability needed for today's auto glass replacements. With a flip of the lever the blade can be adjusted in or out for better clearance on the body during the cut-out, or use the lever for quick blade changes. Solid aluminum handle is contoured for superior grip. Knife comes with one Cat. No. AN1001 Standard Blade.

CRL UltraWiz UltraOne Cold Knife

- Single Set Screw Quick Blade Change
- Uses All 3/4" Shank CRL Blades



new

CAT. NO. AN3005K

This UltraWiz UltraOne Cold Knife is the perfect choice to accompany UltraWiz Blades. It features scratch resistant comfortable foam grips, and a single screw quick blade change feature. The single screw also allows for easy adjustment to the blade length for all applications. This knife comes with one Cat. No. AN1001 Standard Blade.



CRL UltraWiz Cold Knife Blades

- Ultra Fast for Quick Glass Removal
- Use with All 3/4" Shank Handles



CRL UltraWiz Cold Knife Blades are recognized as the industry standard for fast cutting. Fit all standard cold knife handles.

CAT. NO.	BLADE LENGTH (L)
AN1001	3/4" (19 mm)
AN1002	1" (25 mm)
AN1003	1-1/4" (32 mm)
AN1004	1-1/2" (37 mm)

All Cold Knife Blades can be combined for quantity pricing.

CRL UltraWiz UltraThin Cold Knife Blades

- Ultra Thin for Easy Cutting Action
- Use with All 3/4" Shank Handles



CRL UltraWiz UltraThin Blades are 40% thinner to reduce drag. UltraWiz UltraThin Blades also have a double taper sharpened edge to further the quick cutting action.

CAT. NO.	BLADE LENGTH (L)
AN5001	3/4" (19 mm)
AN5002	1" (25 mm)
AN5003	1-1/4" (32 mm)
AN5004	1-1/2" (37 mm)

CRL UltraWiz Molding Blade

- Special Shape to Remove Moldings
- Use with All 3/4" Shank Handles



CAT. NO. AN1005

The CRL UltraWiz Molding Removal Blade has a specially shaped tip that gets under the molding and over the glass edge, saving it for reinstallation.

CRL UltraWiz Molding and Windshield Blade

- Removes Both Molding and Glass
- Use with All 3/4" Shank Handles



CAT. NO. AN1022M

The CRL UltraWiz Molding and Windshield Removal Blade cuts under the molding and the glass edge, saving the molding for reinstallation, and removing the windshield at the same time.

CRL UltraWiz Stainless Steel Cold Knife Blades

- Super Strong
- Longer Lasting Edge



CAT. NO.	BLADE LENGTH (L)
AN7001	3/4" (19 mm)
AN7002	1" (25 mm)
AN7004	1-1/2" (37 mm)

All Cold Knife Blades can be combined for quantity pricing.

CRL Sharpening Stone

- Use to Sharpen Your Cut-Out Blades



CAT. NO. AKDS1

A couple of quick strokes with our Sharpening Stone are all you need to keep your cut-out blades sharp. Long lasting bonded diamonds. Measures 4" by 3/8" (102 mm by 10 mm).

CRL Diamond Whetstone

- Double-Sided, Fine and Coarse



CAT. NO. DWS10

This double-sided (fine and coarse) Diamond Whetstone can quickly sharpen any cut-out blade. Folds into handle for storage. Measures 4" by 1" (102 by 25 mm).

CRL950B Blade

- The Original
- 1/2" Shank



The CRL950B Blade is a long time favorite of the trade, and should only be used on the following Cold Knife Handles: RK160, RK160S, and EUR09.

CAT. NO.	BLADE LENGTH (L)
CRL950B	7/8" (22 mm)

CRL Super Hot Windshield Cut-Out Knife

- Heats to 700°F to 850°F for Fast Cutting
- Easy-to-Use

The CRL Super Hot Windshield Cut-Out Knife assures a smooth, clean, and fast way of cutting out windshields.

Features Include: 250 watts of power; large handle for firm control of blade's cutting edge; rear portion clamp assures positive hold down and better heat transfer; longer stainless steel barrel with three added heat dispersing fins; special steel against steel insert for engaging holding screws; plugs into any 110 VAC outlet. Includes one Cat. No. SHKB149 Cut-Out Blade. **NOTE:** 220 Volt model for foreign use is available on special order.

Note: Urethane windshield adhesives may release isocyanates (toxic gas) when exposed to high temperatures. These isocyanates can be harmful or fatal if inhaled in concentrated amounts. We recommend the user take precautions, such as wearing a respirator that is approved to protect against isocyanate inhalation. We also recommend that all urethane cut-outs be done in areas with adequate ventilation.



CAT. NO. SHK250



CRL Super Hot Windshield Cut-Out Knife Blades

- 100% Copper in Five Models

These CRL Super Hot Knife Blades offer fast cutting action, and are easy to change out. They are specifically designed for use with the CRL Super Hot Windshield Cut-Out Knife.



Our most popular, best selling all-purpose blade.

* Sharpened Edge measures 1" (25 mm)

CAT. NO. SHKB149

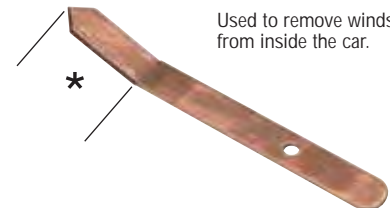

Used to remove windshields from inside the car.

* Sharpened Edge measures 1-1/8" (28 mm)

CAT. NO. SHKB150

Used to remove excess urethane from pinchweld.



* Sharpened Edge measures 1/2" (12 mm)

CAT. NO. SHKB151

Used to cut out lower edge of windshield where urethane is set back from edge of windshield.



* Sharpened Edge measures 1-1/8" (28 mm)

CAT. NO. SHKB152

Used around fenders and hoods where other blades won't allow access.



* Sharpened Edge measures 1" (25 mm)

CAT. NO. SHKB153

CRL Persuader Chisel and Mallet

- Helps Cuts Urethane in Corners
- Simple But Effective

CRL Persuader Urethane Chisel is used to cut the urethane adhesive on the corners of windshields from the inside. This CRL Three Pound Mallet is the perfect choice for use with the Persuader Urethane Chisel.



CAT. NO. RKP100



CAT. NO. ST56703

CAT. NO.	DESCRIPTION
RKP100	Persuader Chisel
ST56703	Three-Pound Mallet



CRL Pull Style U-Blade Knife

- Back Cut Groove for Insert Molding
- Standard and Thin Blades

The CRL Pull Style U-Blade Knife was designed for making re-insertion of push-in moldings easier. Use it to prepare a space between the glass edge and body opening for application of new urethane adhesive and insert molding replacement. Sold with one Standard Blade installed. Standard Blade cuts a 5/16" (8 mm) gap; Thin Blade cuts a 1/4" (6 mm) gap. Cable Pull must be ordered separately.



CAT. NO.	DESCRIPTION
BK1055	U-Blade Knife
BK1056	Standard Blade
BK1057	Thin Blade
RK160CH	Cable Pull Handle



CRL Auto Glass Multi-Knife Kit

- Three Tools in One
- Soft Fit Ergonomic Handle
- Single Screw Quick Change Feature



The CRL Multi-Knife has combined the three most common tools used for auto glass removal, and features a single set screw for quick blade changing. Can be used with all 3/4" shank cold knife blades. The ergonomic solid aluminum foam covered handle comes complete with one Cat. No. AN1001 3/4" Cold Knife Blade, one Cat. No. RSB75 3/4" wide Scraper Blade, one Cat. No. H62750 6-1/2" long Curved Blade, and one Cat. No. 1MKTH T-Pull Handle.

CAT. NO.	DESCRIPTION
1MK	Complete Multi-Knife Kit
1MKH	Contoured Grip Handle Only
1MKTH	Replacement T-Pull Handle
RSB75	3/4" Wide Scraper Blade
H62750	6-1/2" Long Curved Blade

CRL Push Style U-Blade Knife

- Helps Make Reinstalling Plastic Reveal Molding Easy



Push this handy CRL Push Style U-Blade Knife between the body panel and windshield edge to cleanly cut urethane and leave a 1/8" (3 mm) gap for reinstalling the reveal molding. Replacement blades for this convenient body shop tool are quickly and easily changed.

CAT. NO.	DESCRIPTION
RK400	U-Blade Knife
RKB401	Replacement U-Blade



CRL Quickknife™ Quick Release Cold Knife

- Quick Release for Fast Blade Changes
- Uses All 1/2" and 3/4" Shaft Cold Knife Blades



The CRL Quickknife™ Quick Release Cold Knife makes blade changing quick and easy. The cast aluminum handles pivots open for blade removal and replacement. The comfortable handle holds all brands of 1/2" and 3/4" shank cold knife blades. After glass part is removed you can quickly change the knife into a pinchweld scraper to complete the removal process. The Quickknife™ comes in a molded plastic case with Cable Pull Handle, long and short Cut-Out Blades, and a Scraper Blade.

CAT. NO.	DESCRIPTION
EQK425	Complete Quickknife™ Kit
EQR503	Cable Pull Only
RSB75	Scraper Blade Only

CRL Pipe Handle Knives

- Our Most Popular Long Knives
- Available in Two Lengths
- Uses CRL Utility Knife Blades



13" Standard Knife



18" Xtra Long Knife



Old Style Blade Plate

New Style Blade Plate

The cast aluminum handles on our CRL Pipe Handle Cut-Out Knives give you extra reach to cut hardened urethane down below the dash. The handle's round shape is easy to grip, and by adding a length of standard conduit pipe, can be extended for extra length. Three blades are stored in each handle. Both knives use CRL 1991, 1992 and 1993 Series Utility Knife Blades (see page A176).

CAT. NO.	DESCRIPTION
PK19	Standard 13" (330 mm) Pipe Handle Knife
PK19XL	Xtra Long 18" (457 mm) Pipe Handle Knife
PK19PS	Old Style Blade Plate Replacement
PK19NS	New Style Blade Plate Replacement

CRL Sur-Grip 18" Long Knife

- Foam Grip for Comfort
- Painted Steel Shaft



The CRL Sur-Grip 18" Long Knife offers you comfort with control. The 18" length is perfect to reach those below-the-dash urethane beads for easy cut-outs. The soft urethane foam grip provides a positive grasp of the tool. The Sur-Grip features powder-coated, baked-on black crinkle painted steel shaft attached to painted steel tubing with foam grip. Roll pin must be removed to use the CRL Angled Blades shown below.

CAT. NO. HT531

CRL 24" Long Knife

- Extra Long Reach
- Fast Blade Change
- Black Crinkle Painted Aluminum Shaft



CAT. NO. HT532

The CRL 24" Long Knife is long enough to get to those below-the-dash urethane beads that ordinary cut-out knives can't reach. The HT532 features rigid one-inch flat stock aluminum construction. It's finished with a powder-coated, baked-on black crinkle paint that provides a better gripping surface than unfinished aluminum. Can be used with CRL Angled Blades shown below.

CRL Angled Blades for All Long Knives on this Page

Angled Straight Edge Blade

- Longest Reach
- Quick Setup



CAT. NO. RKB471

CRL Angled Long Knife Straight Edge Blade provides you with 4-1/2" of reach and cutting ability for any of your long knives. Quickly bolts to existing blade mounting locations.

Angled Serrated Edge Blade

- Faster Cutting Serrated Edge



CAT. NO. RKB472

For the ultimate in fast cutting, use our Angled Serrated Edge Blade. The serrations quickly cut through the toughest urethane. 4-1/2" long blade quickly bolts to existing blade mounting locations.



CRL Rigid Aluminum Long Knives

- Heavy-Duty Aluminum Shafts
- Double Screw Blade Retainers

These CRL Rigid Aluminum Long Knives use our 1992C and 1993X10 Heavy-Duty Utility Knife Blades to cut through hardened urethane with ease. The long, thin shape of the knife works well for below the dash cut-outs.

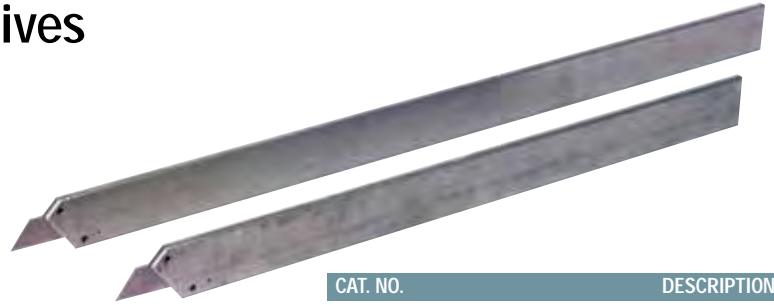

CAT. NO.	DESCRIPTION
UK18	18" (457 mm) Long Knife
UK24	24" (610 mm) Long Knife

CRL Super Grip Aluminum Long Knife

- Finger Grip Handle for a Sure Grip

The CRL 9" Super Grip Aluminum Long Knife has finger grooves for a sure grip. It uses our 1992C and 1993X10 Heavy-Duty Utility Knife Blades to cut through hardened urethane, and works especially well in tight spaces between the dash and the glass.



CAT. NO.	DESCRIPTION
UK9	9" (228 mm) Super Grip Knife

CRL Flexible Long Knife

- Flexes to Glass Curvature
- Rubber Grip



CAT. NO. CRL1119

The CRL Flexible Long Knife has a 14" flexible metal shaft that provides especially long leverage for cutting out difficult urethane set windshields. This knife uses our 1992C Heavy-Duty Utility Knife Blades or 1993X10 Extra Long Utility Knife Blades.

All Long Knives shown on pages A174 and A175 can use the following CRL Utility Blades:

CAT. NO.	DESCRIPTION
1991C	100 Pack Standard Blades
1991X10	10 Pack Standard Blades



CAT. NO.	DESCRIPTION
1992C	100 Pack Heavy-Duty Blades
1992X10	10 Pack Heavy-Duty Blades



CAT. NO.	DESCRIPTION
1993X10	10 Pack Extra Long Blades



For a complete listing please refer to page A176.

CRL Banana Knives

- Hardwood Handle
- Curved Sharp Cutting Edges

CRL Banana Knives are handy tools for cutting out the hard-to-reach urethane below the dash. Made of quality tool steel with a curved sharp cutting area. The hardwood handles are formed for comfort while providing a secure grip.



Scalloped Edge Banana Knife

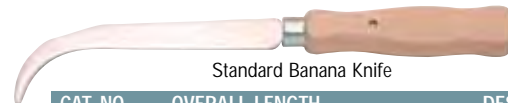

Standard Banana Knife

CAT. NO.	OVERALL LENGTH	DESCRIPTION
BK150	13-1/2" (343 mm)	Scalloped Edge Banana Knife
BK125	9-1/2" (241 mm)	Standard Banana Knife

CRL Protect-A-Dash

- Prevents Costly Damage
- Non-Slip Foam Back - Tough Slick Nylon Front

Keep the "Oops" out of using Long Knives with our Protect-A-Dash. The slick nylon front lets you work quickly to cut away tough urethane while the non-slip foam back keeps the Protect-A-Dash in position.



CAT. NO. CU1077



CRL Standard Duty Utility Knife Blades

- Fit Virtually All Utility and Long Knives



CRL Standard Utility Knife Blades fit all standard, heavy-duty, and retractable blade utility and long knives.

CAT. NO.	DESCRIPTION
1991C	Standard Blades - Pack of 100
1991X10	Standard Blades - Pack of 10

CRL Heavy-Duty Utility Knife Blades

- Our Best-Selling Utility Blades



CRL Heavy-Duty Utility Knife Blades fit all standard, heavy-duty, and retractable blade utility and long knives. They are made to stand up to auto glass removal abuse. Blades in the 100-Pack come in a handy slide-out dispenser.

CAT. NO.	DESCRIPTION
1992C	Heavy-Duty Blades - Pack of 100
1992X10	Heavy-Duty Blades - Pack of 10

CRL Extra Long Utility Knife Blades

- Extra Reach
- Extra Sharp



CRL Extra Long Utility Knife Blades fit all Urethane Knives. They have an exposed cutting edge of 2-1/4" (57 mm), more than double the cutting edge of standard utility knife blades.

CAT. NO.	DESCRIPTION
1993X10	Extra Long Blades - Pack of 10

CRL Hook End Utility Blades

- Can Prevent Damage to Paint



When removing encapsulated windshields, this blade is perfect for cutting away the encapsulation. CRL Hook End Utility Blades fit all standard utility knives.

CAT. NO.	DESCRIPTION
1996C	Hook End Blades - Pack of 100
1996X10	Hook End Blades - Pack of 10

CRL Olfa Heavy-Duty Long Reach Retractable Knife

- Breakaway or Solid Blades
- Stainless Steel Housing with Rubber Grip



Solid Blade



Breakaway Blade

The CRL Olfa Heavy Duty Long Reach Retractable Knife was designed with hard to reach places in mind. Reaching along the bottom of windshields will no longer be a problem with our XL2 Long Reach Knife. It has a locking thumbscrew; stainless steel housing and rubber grip provides safety and extra needed comfort when using this knife.

CAT. NO.	DESCRIPTION
XL2	Olfa Long Reach Knife
LS0L	Solid Blades - Pack of 10
LB10B	Breakaway Blades - Pack of 10

CRL Extra Long Serrated Blades

- Faster Cutting
- Longer Length



CRL Extra Long Serrated Blades measure a full 4-3/16" (106 mm) long. One of the longest blades available and, with the serrated edge, one of the fastest cutting.

CAT. NO.	DESCRIPTION
SB418	Serrated Blades - Pack of 10

CRL Long Curved Blade

- For Use in 1MKH Handle
- 6-1/2" Long for Cutting Below the Dash Area



Handle Not Included

CAT. NO. H62750

The CRL Long Curved Urethane Cut-Out Blade fits the CRL 1MKH Multi-Knife Handle (see A173). At 6-1/2" (165 mm) long this blade is perfect for cutting urethane deep below the dash area.



CRL Ergonomic Grip Pinchweld Scraper Set

- 1/2", 5/8", and 3/4" Wide Blades
- Ergonomic Grips for Comfort
- Shorter Shafts for Added Safety



CAT. NO. 4593

The CRL Ergonomic Grip Pinchweld Scraper Set has three different width blades: 1/2" (12 mm), 5/8" (16 mm), and 3/4" (19 mm). Soft Ergonomic Grips provide improved control and safety when using these sharp tools. Use with bevel side down for added control and less chance of scratching the pinchweld paint or e-coat. The set comes in a molded storage tray.

CRL Pinchweld Scraper

- Wide 7/8" Blade



CAT. NO. 516WT

This CRL Pinchweld Scraper works well for trimming down adhesives on the pinchweld. Wide blade quickly removes the urethane with a single pass. Comfortable grip provides complete control. Using the bevel side of the blade down prevents paint and e-coat damage, which can lead to rust development.

CRL Heavy-Duty Scraper Chisel

- Sturdy All Aluminum Handle



CAT. NO. GL100

Our CRL Heavy-Duty Scraper Chisel takes on the really tough jobs, from urethane removal to hardened putty. Aluminum handle provides a secure grip in all conditions. Blade width is 11/16".

CRL Super Pinchweld Scraper

- Easy to Change Surgically Sharp Blades Come in Three Widths

The CRL Super Scraper saves you the time it takes to stop and sharpen your scraper blades. Our blades are available in three widths: 1/2" (12 mm), 5/8" (16 mm), and 3/4" (19 mm). All are surgically sharp, and inexpensive to replace. The CRL Super Scraper has a lightweight aluminum shaft with a flip-top handle that stores extra blades. Comes with five 1/2" blades stored in the handle, and a blade cover for safety. (Blade cover only fits standard 1/2" blades).

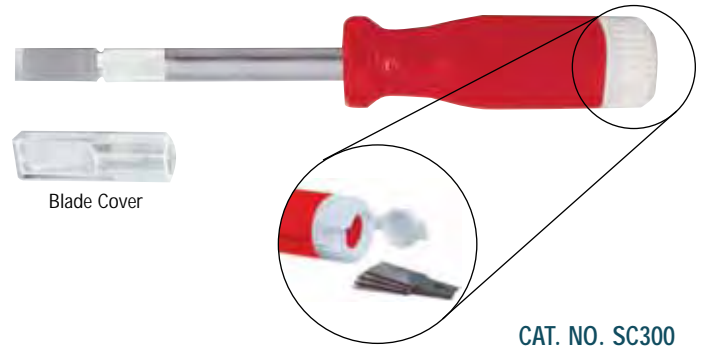

CAT. NO. SC300

Super Scraper 1/2" Blade



CAT. NO. SC301

5 Blades per Pack

Super Scraper 5/8" Blade



CAT. NO. SC302

5 Blades per Pack

Super Scraper 3/4" Blade



CAT. NO. SC303

5 Blades per Pack

CRL Pinchweld Scraper Blade

- Converts Cold Knife Handle Into a Scraper



CAT. NO. RSB75

The CRL Pinchweld Scraper Blade, when used with the CRL 1MKH Multi-Knife Handle, offers you control and safety. Because this blade is shorter than most pinchweld scrapers, it is easier to control during the cutting process, making it much safer to use.

The RSB75 Blade will also fit most other cold knife handles, including: RK160, RK160S, AN2001M, AN2002M, AN3001K, AN3005K, AN3007K, RK500, and RZ500.



CRL Scrape and Pry Bar

- Our Most Popular Pry Tool is Ideal for Pulling Nails, Prying, Lifting, Scraping, and Much More



CAT. NO. 4050

The CRL Scrape and Pry Bar is a versatile tool made of the finest hardened, tempered tool steel. Both ends are chisel ground, 1-3/4" (44 mm) wide, for scraping or prying. One end has a 50-degree angle bend and nail puller hole. Our most popular model, just the right size for your tool box.

CRL Heavy-Duty Razor Scrapers

- Perfect for Scraping or Sticker Removal
- Hold Both Metal and Plastic Razor Blades

CAT. NO. CRL761

Overall length is 11" (279 mm). Comes with one steel and one plastic razor blade in the hollow handle.



CAT. NO. L52000

Overall length is 11" (279 mm). Comes with one plastic and five steel razor blades in the hollow handle.



CRL Razor Blade Holder and Scraper

- Safely Holds Single Edge Metal Razor Blades
- Comfortable Handle for a Sure Grip

new

The new CRL Razor Blade Holder and Scraper is a safe and easy way to handle single edge metal razor blades for all your scraping jobs. The blade end is molded into a plastic handle that provides for a comfortable and sure grip, with a metal ferrule so you can hang it up. There is also a slip-on safety cover for the blade edge. Holds our 51S and KKB12 Single Edge Razor Blades (see opposite page). Overall length is 6-1/2" (165 mm).

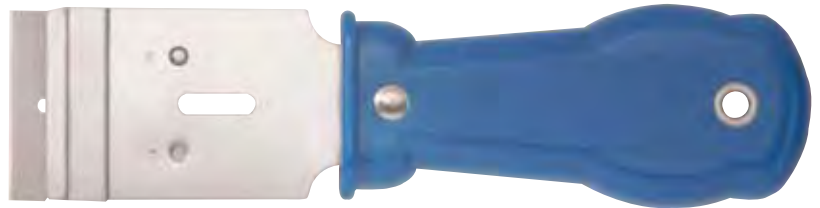

CAT. NO. RS65

CRL Safety Razor Blade Holder and Window Scraper

- Safely Holds All Single Edge Metal Razor Blades
- Buy Them Individually or in Bulk Cartons of 100

For a safe and simple way to hold single edge razor blades try our Safety Razor Blade Holder and Window Scraper. Instantly expose or conceal the blade with a simple thumb lock. All metal tool will withstand lots of use, and has a hole in the end so you can hang it up. Overall length is 4-1/2" (114 mm). Scrapers are available individually, or in bulk boxes of 100 each.



CAT. NO.	DESCRIPTION
3223	Individual Scraper
115000	*Carton of 100 Scrapers

*Minimum order: 100 each.

CRL Plastic Mini Scraper with Razor Blade

new

- A Safe Way to Hold One Single Edge Razor Blade
- Two Pack Blister Card Suitable for Resale

Our Mini Scraper holds one single edge razor blade for scraping or decal removal jobs. Two-pack blister card is suitable for resale, or to just throw in your tool box for whenever you need one. Each scraper comes with one metal razor blade. Packs are available individually, or in cartons of 10 carded packs.



CAT. NO. 20075
Two per pack



LOG ON TO crlaurence.com FOR BUSINESS-TO-BUSINESS SERVICES

A178 | PHONE (800) 421-6144 | FAX (800) 262-3299 TOLL FREE FROM ANYWHERE IN THE U.S.A. OR CANADA

CRL Single Edge Razor Blades - 100 Packs

- Our Most Popular Single Edge Blade
- Precision Honed, Surgical Steel Edges
- Individually Wrapped to Protect the Edge

This CRL Single Edge Razor Blade is top quality, industrial grade, .009" thick surgical steel precision-honed for extra sharpness. It delivers durability along with the exacting quality cut that professionals demand. Packed 100 each per box, there are 50 boxes per case. Each blade is individually wrapped to protect the edge until you are ready to use it.



CAT. NO. 515



CRL Heavy-Duty Industrial Razor Blades - 100 Packs

- Extra Rigid Single Edge Blades with No Notch
- For Use in Paint Scrapers and Mat Cutters



CAT. NO. KKB12

Our CRL Heavy-Duty Razor Blades are more rigid than our regular razor blades because of their .012" thick steel construction, and because they have no side notches. Their extra rigidity makes them great for really tough scraping jobs. Packed 100 per box, 50 boxes per case.

CRL Single Edge Razor Blades - 10 Packs

- Plastic Storage Container for Easy Dispensing



CAT. NO. 112020

CRL Single Edge Razor Blades are available in packs of ten loaded in this handy, spring-loaded plastic dispenser pack. It is perfect for your tool box, glove compartment, or work bench.

CRL Plastic Razor Blades - 100 Packs

- Your Choice of Single Edge or Double Edge Blades
- Won't Harm Surfaces That Could Be Damaged by Metal Razor Blades
- Fits Most Razor Blade Scrapers

These CRL Plastic Razor Blades won't harm plastic coated windows or other hard surfaces that can be scratched or marred by metal razor blades. They are also useful for working on painted surfaces or chrome, and for removing decals, pin striping, or window tint film. New Double Edge Blade has very thin, yet stiff edges for delicate scraping jobs. Choose from single edge or double edge versions to fit your razor blade scraper (see opposite page). Both are sold 100 per package.

new



Single Edge Blades
CAT. NO. CP866088



Double-Edge Blades
CAT. NO. CRL3000

CRL Dremel Mini-Mite Cordless Rotary Tool

- Small, Powerful and Lightweight
- Runs at 5,000 and 10,000 RPM
- Excellent for Pinchweld Rust Removal



This small yet powerful tool for the home and shop fits right into your hand, giving you the kind of maneuverability not usually found in a rotary tool. The D750 accepts Dremel and other bits with shanks up to 1/8" diameter. Battery pack, charger, and five bits included.

CAT. NO.	DESCRIPTION
D750	Dremel Mini-Mite Tool

CRL Dremel Moto Tool Kit

- 40 Piece Bit Assortment Included
- Variable Speed (5,000-30,000 RPM)
- Dozens of Auto Shop Uses

The CRL Dremel Motor Tool Kit consists of a Model 395 variable-speed (5,000-30,000 RPM) Moto Tool with ball bearing motor construction to reduce friction for longer life; double insulated motor so grounding is not required; thrust bearing for greater drilling capacity; compact two wire coil cord for convenient storage in kit box. The tapered housing shape is comfortable for fingertip control. The keyless chuck allows fast replacement of bits with shanks up to 1/8". Adapter uses collets from 1/32" to 1/8" for fine control.



CAT. NO.	DESCRIPTION
D3950	Dremel Moto Tool Kit

CRL 3M™ Radial and Roloc Bristle Discs

- Perfect for Rust Repair on Pinchwelds
- Cleaner and Faster Than Wire Wheels
- Low Impact Sanding

When used for pinchweld rust repair work, 3M™ Radial Bristle and Roloc Bristle Discs are the fastest, cleanest, and most efficient way to prepare the surface for rebonding. Use Radial Disc 3M4094 for long straight areas, and Roloc Bristle Discs 3M7524 and 3M7530 for corners and hard to get at edges. The patented abrasive-filled bristles apply a continuous, fresh supply of sharp 3M™ Regalite mineral to the work piece as the disc wears away.

CAT. NO.	DESCRIPTION
3M4094	50 Grit 3" Radial Bristle Disc
3M7530	50 Grit 1" Roloc Bristle Disc
3M5538	Holder for 1" Bristle Disc
3M7524	50 Grit 2" Roloc Bristle Disc
3M5539	Holder for 2" Bristle Disc



3M4094



3M7524



3M5538



3M7530



3M5539

CRL Powered Cut-Out Knives

Cutting out urethane set windshields is always a tough job, unless you have some help. Getting a power assist from an electric or pneumatic cut-out tool can make a difficult job easier, and add cost-efficiency by saving valuable labor time. CRL has a complete assortment of these tools that will make you more efficient and profitable. To see them all, turn to pages A184 to A201, or visit our web site at crlaurence.com.



AK60TOOL



AK20TOOL



FK06



EQM60D



CRL Humidity/Temperature Pen

- A Must for Determining Urethane Cure Rates



CAT. NO. HTP4093

The CRL Humidity/Temperature Pen has fast response solid-state sensors which continuously and simultaneously display both Relative Humidity and Air Temperature (°F/°C) with a dual-recall memory. The large, 1/2" LCD memory display registers the highest and lowest humidity/temperature achieved during any time period.

Temperature range is 32.0 to 122.0°F (0.0 to 50.0°C), with a resolution of 0.1° and an accuracy of 1°C. Relative humidity range is 2 to 98%, with a resolution of 1% and an accuracy of 2% (mid range) to 4% (end-of-range). The display shows changes in less than 30 seconds, and is updated every second. This is an indispensable tool for any installer. Supplied with two silver-oxide batteries.

CAT. NO.	DESCRIPTION
HTP4093	Humidity/Temperature Pen
1039RB	1.5V DC Replacement Battery

CRL 6" Disposable Brush

- Natural Horse Hair Bristles
- Perfect for Applying Pinchweld Primers



CAT. NO. 1AB

The CRL 6" Disposable Brush applies primers, acids, and flux. They are 6" (152 mm) long, with a 3/8" (9.5 mm) round rolled steel handle, and 3/4" (19 mm) stiff horsehair bristles. Minimum order is 24 each.

CRL 3" Brush

- Great for Removing Heavy Dirt and Debris from Pinchweld Area



CAT. NO. LAB2634

You should always remove as much contamination from the pinchweld area as possible prior to cutting back the OEM urethane bead. Cutting the bead down to size without cleaning the road debris and dirt from this area allows this contamination to fall onto the freshly trimmed urethane bead. This brush's pure black pig bristle is chisel shaped and perfect for reaching in between the urethane bead and the body of the vehicle for cleanup. Double thick, flat 3" (76 mm) wide brush has a panel-type handle for easy, flexible use.

CRL Paint Prep Pen

new

- Thousands of Glass Fibers to Sand Away Rust on Pinchweld
- Small Tip Provides Easy Access Into Tight Spaces



CAT. NO. P3437

This CRL Paint Prep Pen has thousands of glass fibers bundled to form a sanding surface that can sand away rusted areas or bare metal scratches in preparation for pinchweld primer application. The small tip provides easy access to tight places. Two refill cartridges of glass fibers are contained in the handle so you are always prepared.

CRL Cotton Swabs with Wooden Shafts

new

- Perfect for Applying Pinchweld Primers

CRL Cotton Swabs with Wooden Shafts make applying pinchweld primers to small scratches easier than using wool daubers. They can be used with all brands of pinchweld primers.

Minimum order is 100 each.



CAT. NO. 1CS

CRL Ultrasonic Leak Detector

- Wand Style with Headset
- 12 VDC Transmitter Plugs Into Power Port
- Detects Leaks Fast for Better Customer Service

This CRL Wand Style Ultrasonic Leak Detector makes leak detection affordable and fast. This unit finds leaks fast and accurately. If you already have a customer upset with a leaky windshield, you don't want to delay them any longer.

CAT. NO. ALB3050



CRL Triple Strand Braided Cut-Out Wire

- Three Braided Strands for Strength
- Our Most Popular Cut-Out Wire



CAT. NO. TW72

Our CRL Stainless Steel Triple Strand Braided Cut-Out Wire is made of three super strong, stainless steel strands braided to form a .022" diameter wire. 72 feet (21.95 meters) per roll.

CRL Windshield Wire

- Fast Cutting



CAT. NO. WW4

CRL Windshield Wire is a one-pound coil of heavy-duty piano wire for removing windshields. Each coil has approximately 650 feet (198 meters) of wire. For a good grip, try our TWH500 Tightwire Grips shown on the next page.

CRL Stainless Steel Square Wire

- Super High Strength

new



CAT. NO. SSW508

CRL's Stainless Steel Square Wire configuration cuts through even the toughest of urethanes with ease. The square edge of the wire rotates and cuts with amazing speed. Its super strength works to prevent breakage under tough loads. 72 feet (21.95 meters) per roll.

CRL Sidewinder

- Makes Wire Cut-Outs a Simple One Person Job



CAT. NO. VSR73

The CRL Sidewinder is the ideal tool for a one-man wire cut-out operation. Attach the powerful vacuum cup to the inside of the windshield. An aluminum swivel, riding on a ball bearing, allows the swivel to follow the wire. Attached to the swivel is a spring that acts as a second person; you pull the wire, make your cut and the spring pulls the wire back so you can make another cut. Kit contains one Sidewinder Cut-out Tool, one roll TW72 Triple Strand Wire, one WS82 Wire Starter Tool, and one set TWH500 Tightwire Grips.

CRL Windshield Removal Kit

- All in One Kit That Quickly Cuts Through Stubborn Urethane

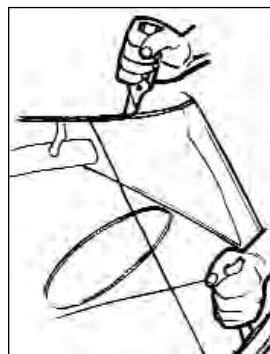

CAT. NO. S21400

This CRL Windshield Removal Kit is designed to provide a quick, efficient and economical method for removing stationary glass. The uniquely designed wire guide handles allow the wire to be guided along the glass for an efficient, smooth cut, greatly reducing glass and wire breakage. The thin blade inserts windshield wire through the adhesive without applying the pressure that could crack the glass. Kit includes Wire Starter, two Handles, and 100 feet (30.4 meters) of Windshield Wire.



CRL Tightwire Grips

- Solid Aluminum with Vinyl Grips
- Unique Wire Locking Feature

CRL Aluminum Tightwire Grips hold on to windshield wire securely. The vinyl grips allow you to tighten and loosen them quickly by hand. Wire ends are contained within handle to prevent injury. Sold only by the pair.
NOTE: Wire not included.

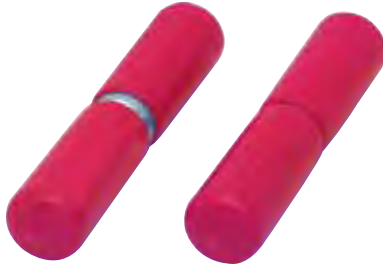

CAT. NO. TWH500

CRL Grip-Tite Handles

- Positive Control
- Ergonomic Grip

CRL Grip-Tite Handles will give you a better grip on wire cut-out jobs. A hollowed out, wedged shaped shaft is the secret to these unique wire grips. Grip-Tite's design keeps the wire away from your fingers at any angle. Contoured handle gives you a non-slip grip. Sold only by the pair.

NOTE: Wire not included.



CAT. NO. LWH200

CRL CenterStart™ Wire Starter Tool

- Long Reach for Starting Wire
- Tough Spring Steel



CAT. NO. PK789

This CRL CenterStart™ Wire Starter helps get you started on those tough wire cut-outs. It is designed to push the wire far below the dash and through the urethane. Just place the end of the wire in the slot at the tip and push through the urethane bead.

CRL Long Shaft Windshield Cut-Out Wire Guide

- Protects Dash from Damage
- Maintains Control of Wire

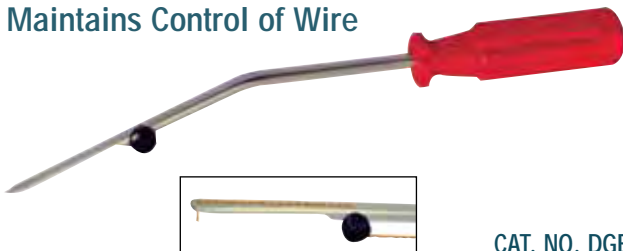

CAT. NO. DGE100

The CRL Long Shaft Windshield Cut-Out Wire Guide is long and narrow enough to protect the dash and interior moldings from being damaged. Run the wire through the hole at the end of the tool, attach the end of the wire in the hole midway, and lock it in place with the set screw. As the tool is moved inside the vehicle, the outside person follows and cuts.

CRL WireStarter™

- Hollow Stainless Steel Tube Inserts Wire Quick and Easy

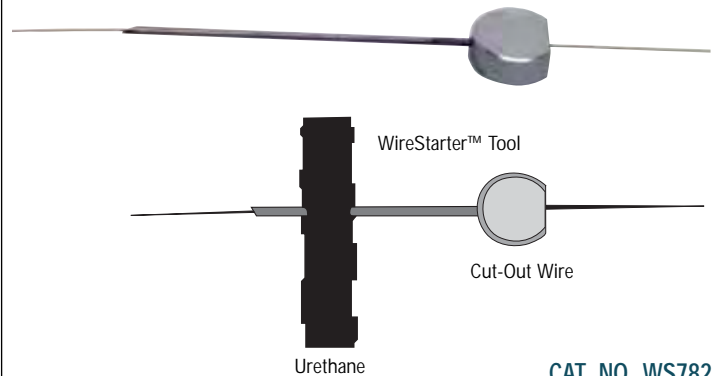

CAT. NO. WS782

The CRL Wirestarter makes the task of pushing the cut-out wire through urethane simple. Just fit the wire through the center of the tool and push. Now you're ready for the cut-out.

CRL WireGuard

new

- Maintains Wire Close to Glass
- Prevents Damage to Dash and Moldings



CAT. NO. GWH366

The CRL WireGuard holds the cut-out wire tight to the glass and prevents damage to trim moldings and the dash. The metal bar provides easy movement of the wire. WireGuard is moved along the glass without removal by spraying water or glass cleaner on the glass as you go.

CRL POWR-Cat Oscillating Pneumatic Knife

- Industrial Grade Air Motor Oscillates at Over 20,000 RPM
- Longer Body for Better Control
- Hex Blade Mounting Collar Holds All Oscillating Cut-Out Blades

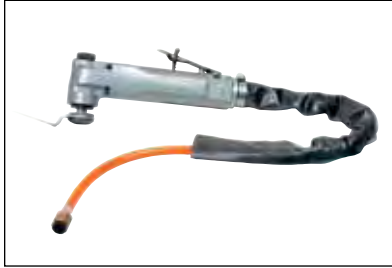

CAT. NO. AK60T00L

The constant search for high quality urethane cut-out systems has led us to develop the CRL POWR-Cat Oscillating Pneumatic Cut-Out Knife. This heavy-duty pneumatic tool features a large, industrial grade air motor which delivers 20,000 oscillations per minute, plenty of power for your toughest cut-out needs.

The long housing of the tool provides excellent balance and control while in use. The hex blade mounting collar gives the POWR-Cat the versatility of being able to use a wide range of blades, including all CRL Oscillating, Time Saver™, and Fein Cut-Out Blades. Blades must be ordered separately. Operates at 90 psi and requires 4 cfm of air.

CRL POWR-Cat Oscillating Pneumatic Knife Basic Kit

- Includes Four Popular Blades
- Industrial Grade Air Motor Oscillates at Over 20,000 RPM
- Hex Blade Mounting Collar Holds All Oscillating Cut-Out Blades



CAT. NO. AK60K1T

Our POWR-Cat Basic Knife Kit has our AK60T00L packaged with four of the most popular oscillating cut-out blades. The kit includes the POWR-Cat Air Tool, and one each RD081 Straight Blade, RD105 Serrated Blade, RD111 Hook Blade, and RD115 Scraper Blade. It's a great starter kit, and you can add blades as required for different applications.

CRL POWR-Cat Oscillating Pneumatic Knife Deluxe Kit

- Complete Kit with POWR-Cat Tool, Four Blades, and Accessories
- Uses All Oscillating Cut-Out Blades with Six or Twelve Sided Mounts



CAT. NO. AK70

The CRL POWR-Cat Deluxe Kit Includes: POWR-Cat Air Tool, Four Cut-Out Blades, Sharpening Stone, Allen Wrench, Male Hose Coupler, Male Hose Plug, Female Hose Coupler, Female Hose Plug, Air Filter and Moisture Trap, In-Line Oiler, Pneumatic Tool Oil, 25 Foot Coiled Air Hose, 2" Duct Tape, 1" Blue Molding Tape, 2" Blue Molding Tape. All packed in an impact-resistant carrying case.



CRL Wildcat Pneumatic Knife

- Lightweight and Powerful
- Uses All Oscillating Cut-Out Blades
- Delivers Up to 20,000 Oscillations per Minute



CAT. NO. AK20TOOL

The CRL Wildcat Pneumatic Air Knife is a lightweight variable speed air tool that delivers up to 20,000 oscillations per minute and, when used with CRL Oscillating Cut-Out Blades, cuts through hardened urethane with ease. The compact design of the CRL Wildcat Tool makes it easy to operate in tight quarters, and the hex blade mounting collar allows for variable positioning of the blade.

The speed control trigger is equipped with a safety stop to prevent accidental starts. **NOTE:** The tool operates between 75 and 90 pounds per square inch maximum air pressure, so a regulated air supply is essential. An air supply or compressor with a 20 gallon tank that delivers 6.3 cubic feet per minute and 90 pounds per square inch is required for optimum performance. Tools comes with a 4mm Allen Wrench (Cat. No. 4MM), but blades must be ordered separately.

CRL Wildcat Pneumatic Knife Basic Kit

- Basic Tool Kit to Get You Started
- Includes Two Blades
- Uses All Oscillating Cut-Out Blades



CAT. NO. AK10

Our Wildcat Pneumatic Knife Basic Kit has the basics for getting started. The Standard Blade is extremely versatile, and the Ram Blade works in special applications that require a longer cutting edge. It's a good way to get started if you're not currently using a pneumatic cut-out tool. You can add other blades as you become familiar with different cut-out situations because the Wildcat Tool will work with virtually all oscillating cut-out blades.

The AK10 CRL Wildcat Pneumatic Knife Basic Kit Includes: Wildcat Pneumatic Tool, Wildcat Standard Blade, Wildcat Ram Blade, Sharpening Stone, and a 4 mm Allen Wrench, all packed in an impact-resistant carrying case.

CRL Wildcat Pneumatic Knife Deluxe Kit

- Complete Kit with Tool, Blades and Accessories
- Uses All Oscillating Cut-Out Blades



CAT. NO. AK50

Our Wildcat Pneumatic Knife Deluxe Kit provides you with everything you need for cut-outs, except the compressed air. This kit has most items required to perform back glass and windshield removals, and still allows you to add on the specific blades you may require because the Wildcat Tool will work with virtually all oscillating cut-out blades.

The CRL Wildcat Pneumatic Knife Deluxe Kit Includes: Wildcat Pneumatic Tool, Two Cut-Out Blades, Sharpening Stone, Allen Wrench, Air Filter and Moisture Trap, Pneumatic Tool Oil, In-Line Oiler, 2" Duct Tape, 1/2" Masking Tape, 2" Masking Tape, Magnetic Clip Insertion Tool, Four different CRL Quick Disconnects, 25 Foot Coiled Air Hose, and 24 CRL Slider Clips, all packed in a high impact carrying case.

CRL Encapsulated Back Glass Removal Blade

- Faster Slider Installations
- No Need to Remove Headliner
- Fits All Oscillating Knives with Six and Twelve Sided Blade Mounts

This CRL Encapsulated Back Glass Cut-Out Blade for Wildcat, POWR-Cat or other oscillating cut-out knives has double machined edges, resulting in one of the thinnest and sharpest blades available. A special tempering process gives them more flexibility and reduces blade breakage. This blade allows the removal of OEM encapsulated rear sliding windows without removing the headliner. A real time saver, it's perfect for the Dodge Ram and other trucks with encapsulated back glass.



CAT. NO. RD924

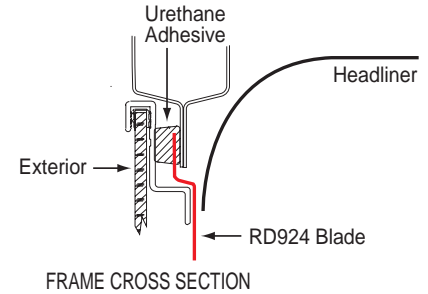

CRL Oscillating Knife Blades

- A Favorite with Truck Slider Installers
- Fit All Six and Twelve Sided Blade Mounts



CAT. NO. RD115

CAT. NO. AKB300

CAT. NO. AKB200

CRL has developed these special Oscillating Blades just for specific applications. The RD115 is the perfect blade to trim down the urethane bead after the glass has been removed. CRL's AKB300 Blade was made to speed the removal of the rear glass on Dodge Ram Trucks. The AKB200 Blade is used on most other trucks with encapsulated rear glass.

CAT. NO.	BLADE LENGTH AND DESCRIPTION
RD115	7/8" (22 mm) Scraper Blade
AKB300	1" (25 mm) Straight Blade for Dodge Ram
AKB200	1" (25 mm) Straight Standard Blade

All Oscillating Blades can be combined for quantity pricing.

CRL Oscillating "L" Blades

- Fit All Six and Twelve Sided Blade Mounts
- Fast Cutting Action



CAT. NO. V51847

CAT. NO. V51848

CAT. NO. V51849

CRL Oscillating Cold Knife Blades for Wildcat and other oscillating cut-out knives have double-machined edges to produce the thinnest and sharpest blades available. A special tempering process gives them more flexibility and reduces blade breakage. These CRL Oscillating "L" Blades are designed to fit Wildcat, POWR-Cat, Fein, and other knives using six or twelve sided blade mounts.

CAT. NO.	BLADE LENGTH
V51847	3/4" (19 mm)
V51848	1" (25 mm)
V51849	1-1/2" (38 mm)

All Oscillating Blades can be combined for quantity pricing.

CRL Time Saver™ Blades

- Fit All Six and Twelve Sided Blade Mounts
- Tempered Steel

CRL Time Saver™ Blades give you the extra reach you need to cut out those difficult windshields with long cowl from inside the car. NOTE: Because of the length of this blade the TSB105 should only be used with the FK6625 Fein Pneumatic Cut-Out Tool.



CAT. NO. TSB55

CAT. NO. TSB35

CAT. NO. TSB65

CAT. NO. TSB85

CAT. NO. TSB105

CAT. NO.	OVERALL BLADE LENGTH
TSB35	5" (127 mm)
TSB55	5-1/2" (140 mm)
TSB65	6-5/8" (168 mm)
TSB85	8-5/8" (219 mm)
TSB105	10-5/8" (270 mm)

All Oscillating Blades can be combined for quantity pricing.



CRL Straight Oscillating Cut-Out Blades

- Fit All Six and Twelve Sided Blade Mounts
- For Interior and A-Pillar Use

CRL Straight Oscillating Blades fit all oscillating cut-out knives using six or twelve sided blade mounts. These CRL Oscillating Blades have double machined edges to produce the thinnest and sharpest blades available. Straight blades are used primarily from the interior up the A-pillar and across the top of the windshield. **NOTE:** Never use the pinchweld as a stop for the blade penetration. Mark your blade at 1/2" and 3/4" so you know the depth of your blade. This reduces the chance of scratching the paint and creating rust.

CAT. NO.	OVERALL LENGTH	SHARPENED AREA
RD081	3-3/4" (95 mm)	2" (51 mm)
RD097	5" (127 mm)	2" (51 mm)
RD106	2-5/8" (67 mm)	1-3/8" (35 mm)
RD103	2-5/8" (67 mm)	7/8" (22 mm)
RD105	2-5/8" (67 mm)	1" (25 mm)

All Oscillating Blades can be combined for quantity pricing.

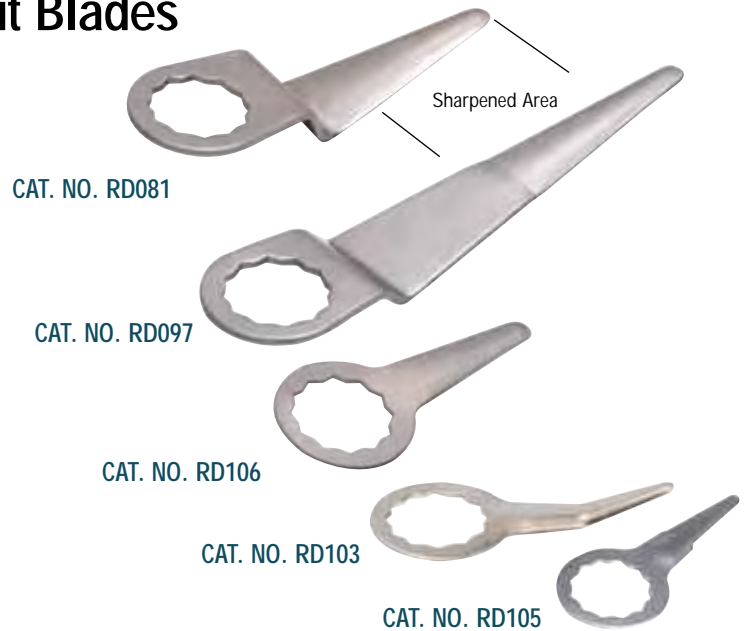

CRL Hook Oscillating Cut-Out Blades

- Fit All Six and Twelve Sided Blade Mounts
- Extra Long Reach

CRL Hook Oscillating Blades fit all oscillating cut-out knives using six or twelve sided blade mounts. Hook Blades are normally used from the exterior of the vehicle, and provide you with the extra reach needed to cut the urethane bead along the bottom of the windshield. **NOTE:** Care should be used when using these blades as the cutting action is on the opposite side of the glass from the operator.

CAT. NO.	SHARPENED AREA
RD107	2-1/2" (64 mm)
RD111	2-3/4" (70 mm)
RD076	7/8" (22 mm)
RD079	1-1/2" (38 mm)

All Oscillating Blades can be combined for quantity pricing.

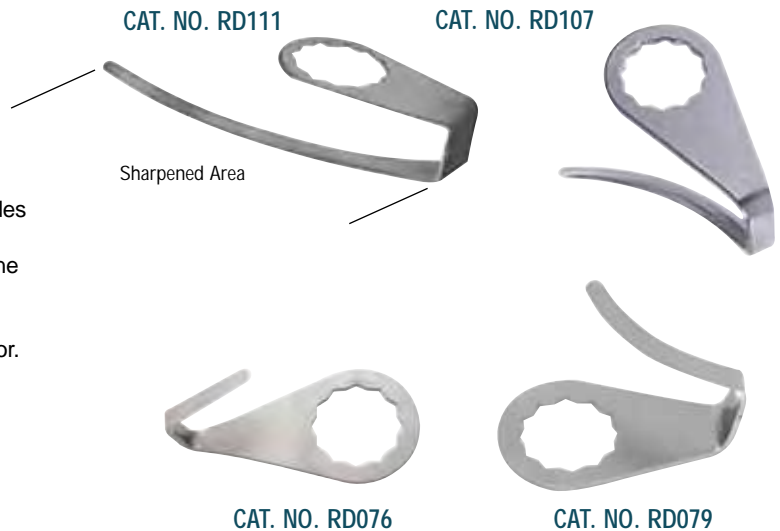

CRL Curved Oscillating Cut-Out Blade

- Fits All Six and Twelve Sided Blade Mounts
- Interior and A-Pillar Use

This CRL Curved Oscillating Cut-Out Blade is used inside or outside the vehicle along the A-pillar post for quick cut-outs. Sharpened area is 2" (51 mm).



CAT. NO. RD072

CRL Plastic Spray Bottle

- Use with Plain Water to Lubricate and Cool Blades as You Cut

No matter which power tool or blade selection you have made, using our Plastic Spray Bottle with plain water will speed your removal process. The water lubricates and cools the blade, reducing friction to speed removal. Water is best used as a lubricant since it will not contaminate the bonding area. Bottle capacity is 16 fluid ounces (.473 liters).



CAT. NO. DB21

CRL Fein Pneumatic Cut-Out Tool

- Robust Motor
- Ball Bearing Construction
- Uses All Oscillating Blades with Six or Twelve Sided Mounts



The economy and ease of a pneumatic cut-out tool can be found in this latest quality-crafted addition from Fein Power Tools. The CRL Fein Pneumatic Cut-Out Tool is compact, only weighing two pounds. With minimal regular maintenance, this tool will deliver constant, trouble free service.

The FK6625 tool comes complete with a spanner wrench for blade changing, a maintenance manual and instructions. No blades come with the FK6625, which accepts all oscillating cut-out blades with six and twelve sided mounts. Requires 90 psi with 3 cfm air consumption.

CRL Fein Serrated Gator "L" Blades

- Fit All Six and Twelve Sided Blade Mounts
- Serrated for Faster Cutting

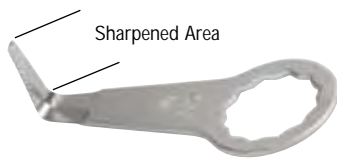

CAT. NO. FKB208

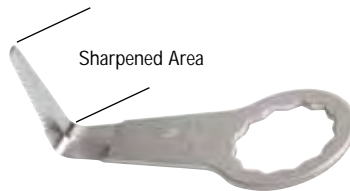

CAT. NO. FKB207

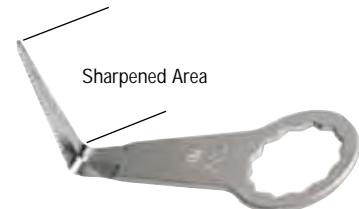

CAT. NO. FKB209

Use these CRL Fein Gator Blades for exterior cutting along the A-Pillar and roof area, or on the interior A-Pillar. Serrated leading edge performs the cut faster and smoother than other oscillating blades. Engineered with outstanding durability, hardness, and flexibility to hold up to the toughest jobs. Sold only in packs of two.

CAT. NO.	SHARPENED AREA
FKB208	3/4" (19 mm)
FKB207	1" (25 mm)
FKB209	1-1/2" (38 mm)

All Oscillating Blades can be combined for quantity pricing.

CRL Fein Serrated Gator "U" Blades

- Fix All Six and Twelve Sided Blade Mounts
- Serrated for Faster Cutting

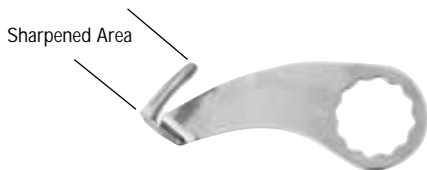

CAT. NO. FKB210

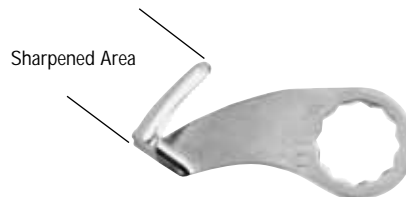

CAT. NO. FKB211

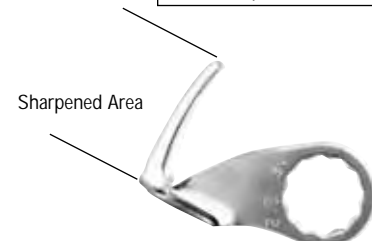

CAT. NO. FKB212

CRL Fein Gator Blades will have you done with your toughest job faster. Serrated leading edge performs the cut faster and smoother than other oscillating blades. Engineered to work well from the exterior, with outstanding durability, hardness, and flexibility to hold up to the toughest jobs. Sold only in packs of two.

CAT. NO.	SHARPENED AREA
FKB210	3/4" (19 mm)
FKB211	1" (25 mm)
FKB212	1-1/2" (38 mm)

All Oscillating Blades can be combined for quantity pricing.



CRL Fein Straight Blades

- Fit All Six and Twelve Sided Blade Mounts
- For Interior and A-Pillar Use

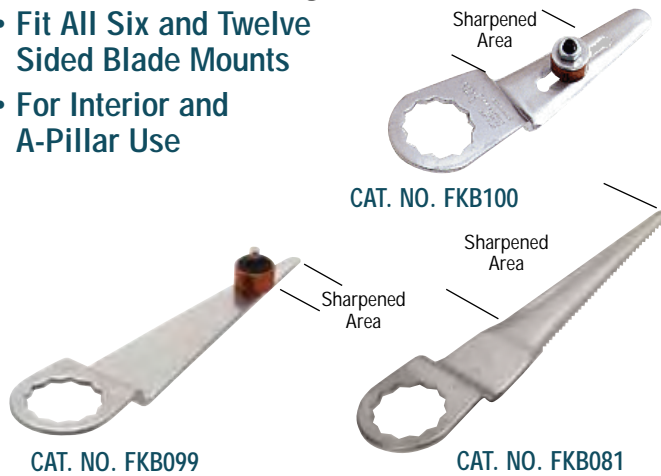

CRL Fein Straight Blades work well from the inside of the vehicle. If the sides of the exterior of the A-pillar urethane bead are exposed these blades make short work of cutting along this area. Both the FKB100 and the FKB099 have depth control stops built into the blade to minimize paint damage during the removal.

CAT. NO.	SHARPENED AREA / DESCRIPTION
FKB081	2-3/8" (68 mm) Straight Blade
FKB099	5/8" (15 mm) Straight Blade with Guide Wheel
FKB100	5/8" (15 mm) to 1-1/2" (38 mm) Adjustable Blade

All Oscillating Blades can be combined for quantity pricing.

CRL Fein Hook Blades

- Fit All Six and Twelve Sided Blade Mounts
- Long Reach for Cutting from the Exterior

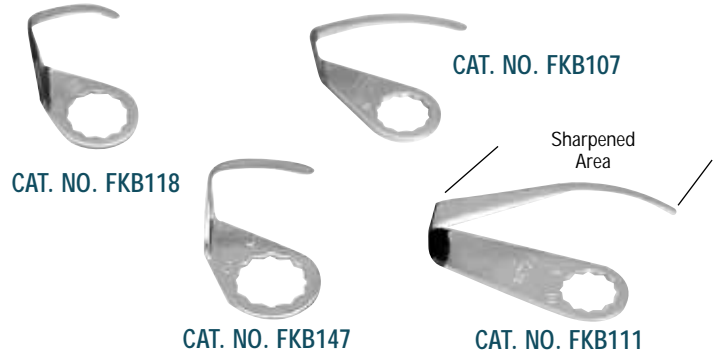

CRL Fein Hook Blades are used along the bottom of the windshield from the exterior, and work best when using the Fein Knife with a pull handle. **NOTE:** Care should be taken to prevent damage to the dash or moldings when using these blades because the cutting action is on the opposite side of the glass from the operator.

CAT. NO.	SHARPENED AREA / DESCRIPTION
FKB118	3/4" (19 mm) Hook Blade
FKB147	1-1/4" (32 mm) Hook Blade
FKB107	2-3/8" (60 mm) Hook Blade
FKB111	3-3/4" (95 mm) Hook Blade

All Oscillating Blades can be combined for quantity pricing.

CRL Fein Specialty Blades

- Curved and Bent Styles



The FKB072 works very well for quarter glass removal with the slight curve and step bend in the blade used as a depth stop, which helps prevent damage to the paint. The FKB104 is used for back glass and truck slider removal. The angled bend in the blade helps when inserting into the urethane around the encapsulation, and also acts as a depth controller to prevent paint damage.

CAT. NO.	SHARPENED AREA / DESCRIPTION
FKB072	1-3/16" (30 mm) Curved Blade
FKB104	3/4" (19 mm) 90° Bent Up Blade

All Oscillating Blades can be combined for quantity pricing.

CRL Fein Scraper Blades

- Quickly Trims Urethane
- Fits Six and Twelve Sided Blade Mounts



These CRL Fein Scraper Blades are used to trim the urethane from the pinchweld once the glass has been removed. The FKB146 cuts from the end of the blade. The FKB113 Blade has a side-to-side cutting action. The "shoulders" on these blades prevent paint damage.

CAT. NO.	SHARPENED AREA / DESCRIPTION
FKB146	3/4" (19 mm) Scraper Blade (1/pk)
FKB113	2" (50 mm) Axe Style Scraper Blade (2/pk)

All Oscillating Blades can be combined for quantity pricing.

CRL Fein 3-1/8" Circular Saw Blade

- Perfect for Cutting Braces for Sunroof Installations
- Trims Bendover Tabs from Encapsulated Truck Sliders

If you install sunroofs, truck sliders, or van windows you really want to have this blade. The Fein Circular Saw Blade makes cutting braces a breeze. The blade does not spin but oscillates so if you touch it to your skin it won't cut you, but touch it to steel and it sinks in, cutting easily and quickly with full control. Use it to plunge cut the metal bendover tabs in Dodge Ram factory sliders prior to cutting through the urethane. Blade diameter is 3-1/8" (79 mm).



CAT. NO. FKB103

CRL Equalizer® Excalibur

- Fast Cutting Reciprocal Action
- Uses All Equalizer® Blades and Sheaths
- Speeds of Up to 3,200 Strokes Per Minute



The CRL Equalizer® Excalibur is a lightweight, air-powered version of the electric-powered CRL Equalizer®. The .020 inch (.5 millimeter) thick blade reciprocates inside a metal sheath, which protects the dash, garnish moldings, and headliner, and allows you to save encapsulated glass and bonded metal moldings. Excalibur has ball bearing construction and runs at 0 to 3,200 strokes per minute. Best of all, it uses the same blades that are used by all CRL Equalizer® tools.

The EX80D Deluxe Kit contains the following: Excalibur Air Tool, two 4" Blades, two 8" Blades, two 12" Blades, one 4" Stainless Steel Sheath, one 8" Stainless Steel Sheath, one 12" Stainless Steel Sheath, one pair of Safety Glasses, all packed in a metal carrying case. The EX40S Standard Kit ships with the Excalibur Air Tool, one 8" Blade and 8" Stainless Steel Sheath. Operates on 90 psi with 6 cfm air consumption.

CAT. NO.	DESCRIPTION
EX40S	Equalizer® Excalibur Standard Kit
EX80D	Equalizer® Excalibur Deluxe Kit

CRL Equalizer® Sheath Cleaner

- Clean Sheaths Help Keep Your Equalizer® Tool Running Great
- Removes Build-up

The CRL Equalizer® Sheath Cleaning Container will keep your Equalizer® Tool operating at top performance. Urethane and butyl should not be allowed to build up inside the sheaths of your CRL Equalizer® Tool. This build-up can put excess strain on the drive unit. We recommend using CRL2032 General Purpose Solvent and Adhesive Cleaner for soaking the sheaths.



CAT. NO. ESC780

CRL Equalizer® Standard Edge Reciprocal Blades

- Fast Cutting Reciprocal Action
- Fits All Equalizer® Reciprocal Tools



- Super Sharp

CAT. NO.	DESCRIPTION
EQ4LB	4" (102 mm) Standard Blade
EQ8LB	8" (204 mm) Standard Blade
EQ12LB	12" (305 mm) Standard Blade

All Equalizer Blades can be combined for quantity pricing.



CRL Equalizer® Serrated Edge Reciprocal Blades

- Fastest Cutting Reciprocal Action
- Fits All Equalizer® Reciprocal Tools



CAT. NO.	DESCRIPTION
ESB1304	4" (102 mm) Serrated Blade
ESB1308	8" (204 mm) Serrated Blade
ESB1312	12" (305 mm) Serrated Blade

All Equalizer Blades can be combined for quantity pricing.



CRL Equalizer® Reciprocal Blade Sheaths

- Adjustable for Cutting Depth
- Work with All Equalizer® Blades Above

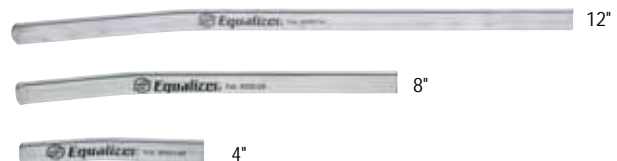

These Equalizer® Sheaths are used with Equalizer® Standard Edge and Serrated Edge Reciprocal Blades. They help protect the dash and paint from blade damage as the tips cut out the adhesive. You can adjust the exposed blade length to accommodate different widths of urethane bead.

CAT. NO.	DESCRIPTION
EQ4SS	Sheath for 4" (102 mm) Blades
EQ8SS	Sheath for 8" (204 mm) Blades
EQ12SS	Sheath for 12" (305 mm) Blades

Sheaths can be combined for quantity pricing.



CRL Extractor Pro Series

- Cuts Through the Toughest Urethane Adhesives
- Makes Difficult Cut-Outs Simple



The CRL Extractor Pro Series makes difficult urethane cut-outs simple, safe, and cost effective. Working either inside or outside the vehicle, removal time will be reduced dramatically with virtually no glass breakage. Used in conjunction with the heavy-duty air tool supplied with each kit, the hardened 4" wide steel blade of the Extractor will easily cut the bottom bead on the most difficult urethane installations.

The EXT100L Kit contains an Extractor Pneumatic Air Tool and EXTLS Long Shaft, a 4" EXTBL Extractor Blade, quick release coupler, and complete instructions. Optional blades and an instructional video are also available. 90 psi and 3.5 cfm is required.



CAT. NO.	DESCRIPTION
EXT100L	Extractor Pro Kit with Long Shaft
EXTBL	Standard 4" (102 mm) Blade
EXTBLLG	Extra Long 4" (102 mm) Blade
EXTBLN	Narrow 1-1/2" (38 mm) Blade
EXTLS	Long Shaft
EXTSS	Short Shaft
EXTAPE	Extractor Pro Instructional Video

CRL Equalizer® Ninja Air-Powered Oscillating Cold Knife

- The Look and Feel of a Cold Knife, but it Cuts with the Power of 22,000 Cutting Strokes Per Minute
- Uses Super Sharp Ninja Blades

The CRL Equalizer® Ninja is an auto glass removal tool that allows you to remove glass fast and effortlessly. It has the look and feel of a cold knife, but it cuts with the power of 22,000 cutting strokes per minute.

A unique feature is Ninja's ability to cut under hoods, trunk lids or anything that hangs over the glass and obstructs your ability to cut. You simply move the blade around so it sits at a 90° angle. This makes the tool short enough to go under these problem areas. 90 psi and 3.5 cfm is required.



The Equalizer® Ninja Deluxe Kit consists of the Ninja with one blade in the tool, hex wrench, and two each 3/4", 1" and 1-1/2" blades, all packaged in a foam-lined, plastic carrying case.



CAT. NO.	DESCRIPTION
ENJ147	Ninja Knife, One ENO841 1" Blade, Cable Pull Handle
ENK148	Ninja Deluxe Kit with Blades and Case
ENT840	3/4" (19 mm) Ninja Blade
ENO841	1" (25 mm) Ninja Blade
ENL842	1-1/2" (38 mm) Ninja Blade

NOTE: Ninja Blades will only fit the Ninja Knife. They will not fit other tools.

CRL Oscillating Power Tool Adapter

- Converts All Standard Cold Knife Blades to Powered Blades
- Fits All Six and Twelve Sided Blade Mounts

This CRL Oscillating Power Tool Adapter converts standard cold knife blades into powered cut-out blades that can be used with Wildcat, POWR-Cat, or other oscillating cut-out knives. Simply bolt your cold knife blade to this attachment and hit the trigger. Saves the cost of expensive oscillating blades. Long lasting tempered steel will provide years of use. Will work with any CRL 3/4" (19 mm) wide cold knife blade. Blades not included.

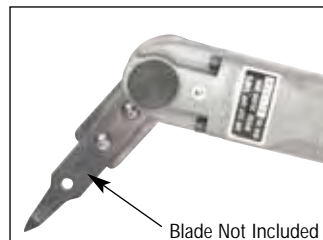

new

CRL BTB Classic Auto Glass Cut-Out Tool Kit

- Removes Any Glass Part Without Breakage
- Saves Moldings
- Blades for Tool Can Also Be Used Manually



CAT. NO. BTB12
Training Video



CAT. NO. BTBCL

Air Pressure: 90 psi (6.2 BAR) Maximum,
Air Consumption: 6.6 cfm

This CRL BTB Classic Auto Glass Cut-Out Tool Kit offers today's auto glass technician all of the tools required for any domestic or import glass removal. With the CRL BTB System the technician can use a variety of blades, either with the power tool or manually, using the handles provided with each kit. The power tool is small and compact, so you can use it in either hand. The air-powered tool provides a strong "in-line" reciprocal stroke, enabling the blade to cut the urethane in hard-to-reach areas. The cut-out depth of the blades is regulated by the use of depth controller arms provided with each kit.

Each BTB Classic Kit contains one of each: Heavy-Duty Air Tool, Serrated Long Universal Flat Blade, General Purpose Bent Blade, Serrated Offset Blade for Curved Glass, Serrated Reverse Offset Blade for Curved and Encapsulated Glass, Left and Right Handed Power Cold Knife Blades, Pinchweld Scraper Blade, Manual Handle for BTB Blades, Training Video, Sharpening Stone, Water Spray Bottle, Allen Wrench Chuck Key, Set of Spacer Tabs, and Three Controller Arms, all packed in a Molded Carrying Case.

CRL BTB Heavy-Duty Air Tool

Whether you already have a BTB Kit and need a back up tool, or you want to build your kit by just purchasing the blades individually, starting with the BTB Heavy-Duty Air Tool is the first step. See specifications above.



CAT. NO. BTB10HD

Blade and
Controller Arm
not Included

CRL BTB Long Blades

- Standard or Serrated Edges
- Tough Spring Steel



CAT. NO. BTB1



CAT. NO. BTB1SC

The CRL BTB Long Blade is used to cut urethane deep below the dash line. Unique to the BTB Tool is that you can perform the removal from the exterior of the vehicle and still reach to the bottom center of most windshields.

CAT. NO.	DESCRIPTION
BTB1	12" (305 mm) Standard Long Blade
BTB1SC	12" (305 mm) Serrated Long Blade

CRL BTB Universal Blades

- Standard or Serrated Edges
- Tough Spring Steel



CAT. NO. BTB2



CAT. NO. BTB2SC

The CRL BTB Universal Blade provides additional benefits over the longer blade as it flexes and contours to the curved glass parts with ease. Great to use in the corners to relieve pressure on the glass when performing a removal while trying to save the part.

CAT. NO.	DESCRIPTION
BTB2	9-1/2" (241 mm) Standard Universal Blade
BTB2SC	9-1/2" (241 mm) Serrated Universal Blade



CRL BTB General Purpose Blades

- Standard or Serrated Edges
- Tough Spring Steel



CAT. NO. BTB3



CAT. NO. BTB3SC

CRL BTB General Purpose Blades have become a favorite with BTB users as it's flexibility and length work in several applications, so changing out to other length blades is not required.

CAT. NO.	DESCRIPTION
BTB3	8" (203 mm) General Purpose Standard Bent Blade
BTB3SC	8" (203 mm) General Purpose Serrated Bent Blade

CRL BTB Powered Cold Knife Blade Sets

- Left and Right Handed Blades
- Standard and Reverse Blades



CAT. NO. BTB27
Standard



CAT. NO. BTB27R
Reverse

These BTB Powered Cold Knife Blades allow you to use your BTB Knife on the exterior of the vehicle and quickly power around the windshield. Use the Reverse Blades for cutting out glass parts without damaging the moldings. One left hand and one right hand blade per package.

CAT. NO.	DESCRIPTION
BTB27	LH and RH Standard Cold Knife Blades
BTB27R	LH and RH Reverse Cold Knife Blades

CRL BTB Manual Handles

- Fits All BTB Blades

Insert BTB Blades into these Handles for those precise cut-outs that may be too delicate to cut with a power tool.

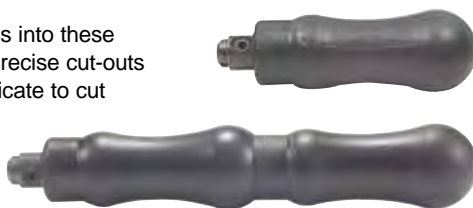

CAT. NO.	DESCRIPTION
BTB7	4" (102 mm) Manual Handle
BTB7L	7-1/4" (184.2 mm) Long Manual Handle

CRL BTB Special Bent Blades

- Standard or Serrated Edges
- Tough Spring Steel



CAT. NO. BTB4



CAT. NO. BTB4SC

CRL BTB Special Bent Blades are the perfect size for A-Pillar cutting or quarter glass removal. You can work close to the body with this blade which provides great control.

CAT. NO.	DESCRIPTION
BTB4	7-1/2" (191 mm) Standard Special Bent Blade
BTB4SC	7-1/2" (191 mm) Serrated Special Bent Blade

CRL BTB Specialty Blades



CAT. NO. BTB24S and BTB24RS



CAT. NO. BTB24ZS and BTB24ZRS

This selection of BTB Specialty Blades provides additional options when using the BTB System. The BTB24S and BTB24RS are perfect for extreme curved glass removal, such as the Saturn. The BTB24ZS and BTB24ZRS are both suited for smaller encapsulated quarter glass removal.

CAT. NO.	DESCRIPTION
BTB24S	9-1/2" (241 mm) Serrated Curved Glass
BTB24RS	Reverse 9-1/2" (241 mm) Serrated Curved Glass
BTB24ZS	6" (152 mm) Serrated Quarter Glass Blade
BTB24ZRS	Reverse 6" (152 mm) Serrated Quarter Glass Blade



CAT. NO. BTB5



CAT. NO. BTB6

The BTB5 Trim Blade quickly trims urethane from the glass part prior to replacement. The BTB6 Pinchweld Scraper Blade makes short work of trimming down the urethane for the installation of the new part.

CAT. NO.	DESCRIPTION
BTB5	5" (130 mm) Trim Blade
BTB6	5" (125 mm) Pinchweld Scraper Blade

CRL Pressure Regulator and Gauge

- Regulates Pressure to Protect Air Tools

The CRL Pressure Regulator and Gauge can handle air line pressures up to 250 psi, and regulate up to 160 psi. Primarily for inline use where pressure variances near the tool could be critical. Consists of pressure regulator, gauge, and 1/4" hose nipples.



CAT. NO. AR1130

CRL Ready Jet Inline Blowgun

The CRL Ready Jet Inline Blowgun fits right in the air line; always ready to direct a blast of air instantly at the touch of a finger. Use it with or without the air tool attached.



Ready Jet Blowgun



Replacement Rubber Tip

CAT. NO.	DESCRIPTION
RJR03	Ready Jet Inline Blowgun
RJT05	Replacement Rubber Tip

CRL Portable Five Gallon Air Tank

- Boosts Air Storage

This CRL Portable Five Gallon Air Tank, when added to a compressor, can boost your air storage capacity, which will reduce the cycle time. Includes three foot length of 1/4" air hose.



CAT. NO. AT05

CRL Coiled Air Hoses

- 25 and 50 Foot Lengths for Most Common Air Tools



CRL Coiled Air Hoses have 1/4" standard NPT Fittings, and can be used with most common pneumatic tools.

CAT. NO.	DESCRIPTION
RAH25	25' (7.6 m) Air Hose
RAH50	50' (15.2 m) Air Hose

CRL 4-hp Gas Powered Compressor

- Small Footprint for Mobile Trucks
- Honda Powered

PRESSURE AND VOLUME REQUIREMENTS

PSI	CFM
125	4.0
100	4.4
40	5.1



CAT. NO. GD4000

This CRL 4-hp Gas Powered Compressor is the perfect size for mobile auto glass trucks and vans. It features a reliable 4-hp Honda engine with overhead valves, dual element air cleaner, and electronic ignition. This heavy-duty single stage compressor features ball bearings, splash lubrication, and metal filter with silencer, stainless steel reed valves, plus fan cooling with fixed rotation speeds. The compressor has a small footprint measuring 22" by 17" by 17" (558 mm by 432 mm by 432 mm).

CRL 2-hp Electric Powered Compressor

- Excellent Choice for Mobile Trucks

PRESSURE AND VOLUME REQUIREMENTS

PSI	CFM
125	3.6
100	4.1
40	5.1



CAT. NO. GD1500

The CRL 2-hp Electric Powered Compressor is sized right for mobile auto glass trucks and vans. It comes with a 2-hp 3,400 rpm motor that features overload protection with manual reset. This compressor has a single stage operation with ball bearings, splash lubrication, metal filter with silencer, stainless steel reed valves, and fan cooling with fixed rotation speeds. The compressor's footprint is only 16" by 16" by 16" (406 mm by 406 mm by 406 mm).



CRL Inline Pneumatic Tool Filter and Moisture Trap

- Prevents Moisture Damage to Tools
- Lubricates Automatically



CAT. NO. AC1025

The CRL Inline Pneumatic Tool Filter and Moisture Trap captures debris and moisture from the air line, and lubricates all at the same time. Can be used with most common pneumatic tools with 1/4" NPT fittings.

CRL Inline Pneumatic Tool Oiler

- Lubricates Automatically



CAT. NO. AC1212

The CRL Inline Pneumatic Tool Oiler automatically oils your air tools as you use them. You can use it with most common pneumatic tools with 1/4" NPT fittings.

CRL Angle Swivel

- Helps Eliminate Twisted Air Lines



CAT. NO. AFSC5

The CRL Angle Swivel makes using air tools easier because it prevents twisted air lines. Extremely handy for working in tight spaces, it can be used with most common pneumatic tools with 1/4" NPT fittings.

CRL Male Plug



CAT. NO. AFMP2

The CRL Male Hose Plug can be used with most common pneumatic tools with 1/4" NPT fittings.

CRL Female Plug



CAT. NO. AFFP4

The CRL Female Hose Plug can be used with most common pneumatic tools with 1/4" NPT fittings.

CRL Male Coupler



CAT. NO. AFMC1

The CRL Male Hose Coupler can be used with most common pneumatic tools with 1/4" NPT fittings.

CRL Female Coupler

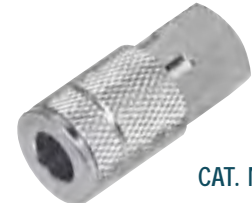

CAT. NO. AFFC3

The CRL Female Hose Coupler can be used with most common pneumatic tools with 1/4" NPT fittings.

CRL Air Filter, Regulator, and Lubricator

- Operates from 0-160 PSI
- Automatic Oiler
- 1/4" NPT Fittings



CAT. NO. 42035

The Filter removes particles and condensation; the Regulator adjusts pressure from 0-160 psi; and the mist lubrication automatically oils your tool.

CRL Pneumatic Tool Oil

- Helps to Keep Your Air Tools Working Right

CRL Pneumatic Tool Oil is to be used with most common pneumatic tools. Our full assortment of Air Tool Accessories work with all standard 1/4" NPT fittings, and make the job of maintaining optimum tool condition easy.

Comes in a 16 fluid ounce (472 milliliter) plastic bottle with a flip up lid for quick application.



CAT. NO. AK01L

CRL Fein Cut-Out Knives

- 28% More Power than Previous Models
- Adjustable Speed Control
- Uses All Blades with Six and Twelve Sided Mounts



CAT. NO. FK06
Standard Kit

The Fein FK06 Standard Kit Contains:

One Fein Cut-Out Tool, one each FKB210, FKB211, and FKB212 Gator "U" Blades, one Spanner Wrench, one Sharpening Stone, and a molded carrying case.

The new CRL Fein Knife has 28% more power than previous models, so it really cuts through tough urethane. Plus, it's slimmer for better clearance, and has an improved speed control that adjusts (7,000 to 23,000 oscillations per minute) to stay constant under light or heavy loads. All mechanical wear parts operate in an oil bath,



CAT. NO. FK6385
Deluxe Kit

The Fein FK6385 Deluxe Kit Contains:

One Fein Cut-Out Tool, one each FKB118, FKB147, FKB081, FKB107, FKB111 and FKB113 Fein Blades, one Spanner Wrench, one Sharpening Stone, and a molded carrying case.

and the tool is vented to run cooler for longer life. All this makes the Fein Knife the time and labor-saving way to remove auto glass on today's vehicles. This knife uses blades that have six or twelve sided mounts, so you can adjust the blade angle as required for each specific vehicle.

CRL Fein Straight Blades

- Fit All Six and Twelve Sided Blade Mounts
- For Interior and A-Pillar Use



CRL Fein Straight Blades work well from the inside of the vehicle. If the sides of the exterior of the A-pillar urethane bead are exposed these blades make short work of cutting along this area. Both the FKB100 and the FKB099 have depth control stops built into the blade to minimize paint damage during the removal.

CAT. NO.	SHARPENED AREA / DESCRIPTION
FKB081	2-3/8" (68 mm) Straight Blade
FKB099	5/8" (15 mm) Straight Blade with Guide Wheel
FKB100	5/8" (15 mm) to 1-1/2" (38 mm) Adjustable Blade

All Oscillating Blades can be combined for quantity pricing.

CRL Fein Hook Blades

- Fit All Six and Twelve Sided Blade Mounts
- Long Reach for Cutting from the Exterior

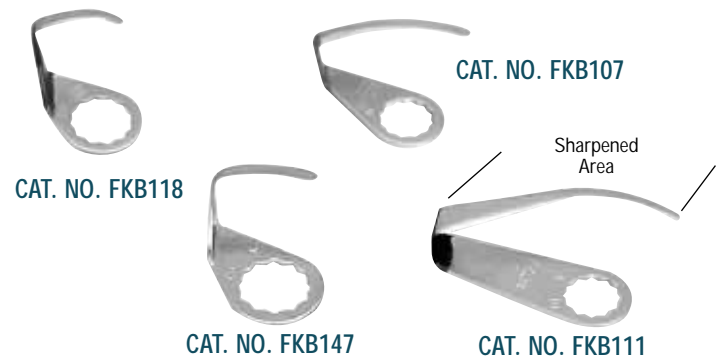

CRL Fein Hook Blades are used along the bottom of the windshield from the exterior, and work best when using the Fein Knife with a pull handle. **NOTE:** Care should be taken to prevent damage to the dash or moldings when using these blades because the cutting action is on the opposite side of the glass from the operator.

CAT. NO.	SHARPENED AREA / DESCRIPTION
FKB118	3/4" (19 mm) Hook Blade
FKB147	1-1/4" (32 mm) Hook Blade
FKB107	2-3/8" (60 mm) Hook Blade
FKB111	3-3/4" (95 mm) Hook Blade

All Oscillating Blades can be combined for quantity pricing.

Blades shown on this page are not warranted against breakage. The blades are made from tempered steel that is strong but brittle, and will break if flexed to an extreme.



LOG ON TO crlaurence.com FOR BUSINESS-TO-BUSINESS SERVICES

A196 | PHONE (800) 421-6144 | FAX (800) 262-3299 TOLL FREE FROM ANYWHERE IN THE U.S.A. OR CANADA

CRL Fein Serrated Gator "L" Blades

- Fit All Six and Twelve Sided Blade Mounts
- Serrated for Faster Cutting



CAT. NO. FKB208

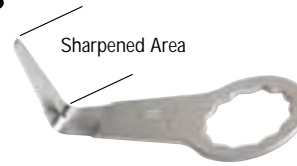

CAT. NO. FKB207

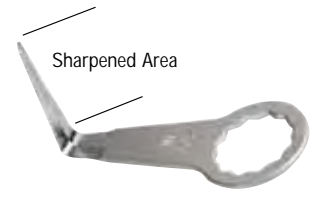

CAT. NO. FKB209

Use these CRL Fein Gator Blades for exterior cutting along the A-Pillar and roof area. Serrated leading edge performs the cut faster and smoother than other oscillating blades. Engineered with outstanding durability, hardness, and elasticity to hold up to the toughest jobs. Sold only in packs of two.

CAT. NO.	BLADE LENGTH
FKB208	3/4" (19 mm)
FKB207	1" (25 mm)
FKB209	1-1/2" (38 mm)

All Oscillating Blades can be combined for quantity pricing.

CRL Fein Serrated Gator "U" Blades

- Fix All Six and Twelve Sided Blade Mounts
- Serrated for Faster Cutting

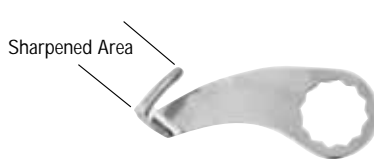

CAT. NO. FKB210

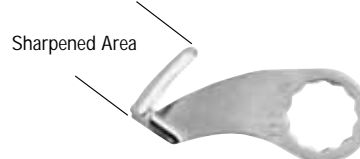

CAT. NO. FKB211

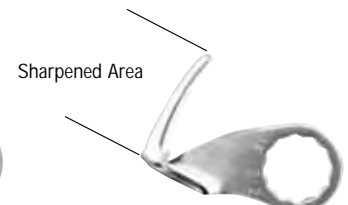

CAT. NO. FKB212

CRL Fein Gator Blades will have you done with your toughest job faster. Serrated leading edge performs the cut faster and smoother than other oscillating blades. Engineered to work well from the exterior, with outstanding durability, hardness, and flexibility to hold up to the toughest jobs. Sold only in packs of two.

CAT. NO.	BLADE LENGTH
FKB210	3/4" (19 mm)
FKB211	1" (25 mm)
FKB212	1-1/2" (38 mm)

All Oscillating Blades can be combined for quantity pricing.

CRL Fein Specialty Blades

- Curved and Bent Styles

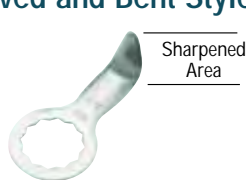

CAT. NO. FKB104

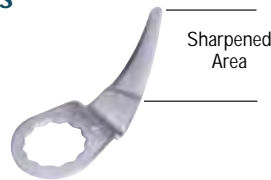

CAT. NO. FKB072

The FKB072 works very well for quarter glass removal with the slight curve and step bend in the blade used as a depth stop, which helps prevent damage to the paint. The FKB104 is used for back glass and truck slider removal. The angled bend in the blade helps when inserting into the urethane around the encapsulation, and also acts as a depth controller to prevent paint damage.

CAT. NO.	DESCRIPTION
FKB072	1-3/16" (30 mm) Curved Blade
FKB104	3/4" (19 mm) 90° Bent Up Blade

All Oscillating Blades can be combined for quantity pricing.

CRL Fein Scraper Blades

- Quickly Trims Urethane
- Fits Six and Twelve Sided Blade Mounts



CAT. NO. FKB146



CAT. NO. FKB113

These CRL Fein Scraper Blades are used to trim the urethane from the pinchweld once the glass has been removed. The FKB146 cuts from the end of the blade. The FKB113 Blade has a side-to-side cutting action. The "shoulders" on these blades prevent paint damage.

CAT. NO.	DESCRIPTION
FKB146	3/4" (19 mm) Scraper Blade (1/pk)
FKB113	2" (50 mm) Axe Style Scraper Blade (2/pk)

All Oscillating Blades can be combined for quantity pricing.

CRL Fein 3-1/8" Circular Saw Blade

- Perfect for Cutting Braces for Sunroof Installations
- Trims Bendover Tabs from Encapsulated Truck Sliders

If you install sunroofs, truck sliders, or van windows you really want to have this blade. The Fein Circular Saw Blade makes cutting braces a breeze. The blade does not spin but oscillates so if you touch it to your skin it won't cut you, but touch it to steel and it sinks in, cutting easily and quickly with full control. Use it to plunge cut the metal bendover tabs in Dodge Ram factory sliders prior to cutting through the urethane. Blade diameter is 3-1/8" (79 mm).

Blades shown on this page are not warranted against breakage. The blades are made from tempered steel that is strong but brittle, and will break if flexed to an extreme.



CAT. NO. FKB103

CRL Fein Spanner Socket

- Fits 1/4" Drive Ratchet Wrench
- Offers Quick Change for Blades

Put this CRL Fein Tool Spanner Socket on any 1/4" drive ratchet wrench (not included) and use it to quickly and easily remove and reinstall the Fein Spanner Bolt. The all metal socket is machined for a snug fit on the Spanner Bolt.



CAT. NO. CRL6365

CRL Fein Spanner Wrench

- Fits New Attachment Nut on Fein Tool
- Heavy Cast Metal

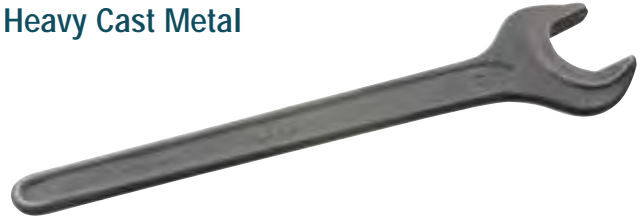

The CRL Fein Knife Spanner Wrench fits all new Fein Cut-Out Knives that have the hex nut retaining bolt, such as the FK06 and FK6385.

CAT. NO. FK0EW

CRL Fein Tool Replacement Spanner Bolt

- Machined Steel
- Fits All Fein Knives
- Use with FKS_W and CRL6365 or FK0EW Spanner Wrenches

The CRL Fein Spanner Bolt will fit all Fein Cut-Out Knives. Don't get caught without a replacement for this vital part.



CAT. NO. FKS_B

CRL Spanner Wrench for Fein Auto Glass Removal Tools

- Machined Steel
- Fits All Fein Tool Spanner Bolts with Two Holes

The CRL Fein Spanner Wrench will fit Fein Spanner Bolts on Fein Tools that have the two hole pattern, such as FK06, FK6385, FK6625, and FK23618.



CAT. NO. FKS_W

CRL Fein Knife T-Handle

- Increases Pulling Power
- Safely Controls Cutting Action

This CRL Fein Knife Pull Handle will provide better comfort and control when cutting with your CRL Fein Cut-Out Knife.



CAT. NO. FK6H

CRL Fein Tool Instructional Video

- Shows How to Effectively Use a Fein Knife

The CRL Fein Knife Instructional Video shows the features and benefits of using the Fein Tool for auto glass removal, as well as the proper blade selection for different cut-outs.



CAT. NO. FKV1V



CRL Extractor Pro 18 Volt Cordless Cut-Out Tool

- 2,000 Smooth and Quiet Strokes Per Minute
- Full Charge Will Remove 6 to 7 Windshields
- Can Be Used for More Than Just Auto Glass

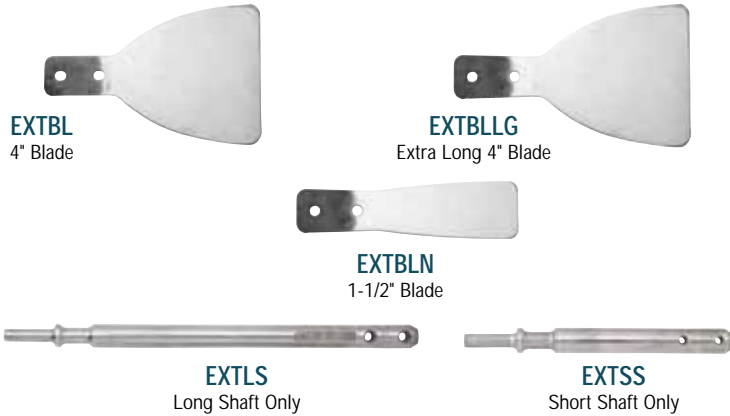

CAT. NO. EXTPROCM2

The CRL Extractor Pro 18 Volt Cordless Cut-Out Tool is one of the most powerful and fast cut-out tools on the market. Capable of removing most windshields in less than three minutes! The flexible blade design allows the Extractor to remove approximately 95% of windshields without damaging the glass. The motor in the Extractor Tool provides 2,000 quiet and smooth strokes per minute, with a stroke length of 3/8" (9.5 mm). Batteries can recharge in approximately one hour. This is a multi-faceted tool you can use for windshield removal, mirror removal, insulated glass deglazing, even putty and tile removal. The EXTPROCM2 Kit contains: one Extractor Pro Cut-Out Tool, one 115V AC Charger, 18 Volt Extended Life Battery, one EXTBL 4" (102 mm) Standard Blade, all packed in a molded carrying case.

CAT. NO.	DESCRIPTION
EXTPROCM2	Extractor Pro 18 Volt Cordless Tool Kit
EXTBLLG	Extra Long 4" (102 mm) Wide Blade
EXTBL	Standard Length 4" (102 mm) Wide Blade
EXTBLN	Narrow 1-1/2" (38 mm) Wide Blade
EXTLS	Long Shaft Only (No Blade)
EXTSS	Short Shaft Only (No Blade)
EXTAPE	Extractor Pro Instructional Video

CRL 18 Volt Cordless Equalizer® Express Cut-Out Tool

- An Extremely Fast Cutting Tool
- Cordless for Full Control
- Flexible Blade Follows Contours



CAT. NO. DTE1000

CAT. NO.	DESCRIPTION
DTE1000	18 Volt Cordless Express Tool Kit
BFE1420	Express Finger Blade
BFE1401	Express 1-1/2" (39 mm) Narrow Blade
BFE1400	Express 3" (76 mm) Standard Blade
RLE1404	Express 3" (76 mm) Long Reach Blade
DW9095	DeWalt 18 Volt Battery Cartridge
DW9108	DeWalt 18 Volt Battery Charger (115V AC)
DW9109	DeWalt 18 Volt Battery Charger (12V DC)

Fast is profitable, and the CRL Cordless Equalizer® Express is fast! Cutting urethane has never been easier. The Express Cut-Out Tool has a flexible blade that follows the contours of the windshield to provide perfect control during the cut-out.

The Express Kit contains: one Express Tool, one DW9095 18 Volt Battery Cartridge, one DW9108 115V AC Charger, one BFE1400 Standard Blade, and an instruction video, all packed in a molded carrying case.

Blades shown on this page are not warranted against breakage. The blades are made from tempered steel that is strong but brittle, and will break if flexed to an extreme.

CRL Equalizer® Magnum

- Cuts at 4,000 Strokes per Minute
- Heavy-Duty One Horsepower Motor



CAT. NO. EQM30S

THE EQUALIZER® MAGNUM STANDARD KIT CONTAINS:
One EQM30S Magnum Tool, one EQ8LB 8" Blade, one EQ8SS 8" Stainless Steel Sheath, and one pair of Safety Glasses.

The CRL Equalizer® Magnum was designed for shops who do a large volume of work, or have fleet accounts with auto dealers and car rental agencies. It has a heavy-duty, one horsepower 115V AC motor, ball bearings, counter-balanced drive, and a heavy-duty gear system. The blade and sheath system provides depth control for the cut-out, and vehicle interior protection during the removal process. The exposed blade length is fully adjustable for varying cut depths. Choose the Magnum that's right for your shop from either our Standard or Deluxe Kits.



CAT. NO. EQM60D

THE EQUALIZER® MAGNUM DELUXE KIT CONTAINS:
One EQM30S Magnum Tool, one EQ4SS 4" Stainless Steel Sheath, one EQ8SS 8" Stainless Steel Sheath, one EQ12SS 12" Stainless Steel Sheath, two EQ4LB 4" Blades, two EQ8LB 8" Blades, two EQ12LB 12" Blades, and one pair of Safety Glasses, all in a molded carrying case.

NOTE: Blades and Sheaths are interchangeable with all other Equalizer® tools.

CAT. NO.	DESCRIPTION
EQM30S	Magnum Standard Kit
EQM60D	Magnum Deluxe Kit

CRL Equalizer® Freedom

- Can Remove Three to Five Windshields on One Battery Charge
- Rechargeable Up to 1,200 Times

Freedom is certainly the operative word in describing this cut-out tool from Equalizer®. No longer are you limited by the lack of a power source or air compressor. The CRL Equalizer® Freedom features an 18 volt battery, which delivers enough power to remove up to five windshields on one charge (depending on how difficult the glass is to remove). A high torque motor drives the blade at 4,000 strokes per minute.

The Equalizer® Freedom uses the latest in battery and motor technology, giving it extreme power for those tough cut-out jobs. The battery can deliver 40% more run time than standard batteries, never develops a "memory", and can be charged up to 1,200 times.



CAT. NO. EQF18

THE EQUALIZER® FREEDOM KIT CONTAINS:
One EQF18 Equalizer Freedom Tool, one EQ4SS 4" Stainless Steel Sheath, one EQ8SS 8" Stainless Steel Sheath, one EQ12SS 12" Stainless Steel Sheath, two EQ4LB 4" Blades, two EQ8LB 8" Blades, two EQ12LB 12" Blades, one Pair of Safety Glasses, one DW9095 DeWalt Nickel Cadmium Battery, one DW9108 115V AC one hour DeWalt Battery Charger, all in a foam lined molded carrying case.

NOTE: Blades and Sheaths are interchangeable with all other Equalizer® tools.

CAT. NO.	DESCRIPTION
EQF18	Freedom Cordless Cut-Out Tool Kit
DW9095	DeWalt 18 Volt Battery Cartridge
DW9108	DeWalt 18 Volt Battery Charger (115V AC)
DW9109	DeWalt 18 Volt Battery Charger (12V DC)



DW9095
Battery



DW9108
115V AC Charger



DW9109
12V DC Charger



CRL Equalizer® Standard Edge Reciprocal Blades

- Fast Cutting Reciprocal Action
- Fits All Equalizer® Reciprocal Tools

CRL Equalizer® Standard Edge Blades are made from quality steel that can be resharpened many times. They are used inside the Stainless Steel Sheaths shown below, and fit in all Equalizer® Reciprocating Tools, including Magnum, Freedom, and Excalibur.



CAT. NO.	DESCRIPTION
EQ4LB	4" (102 mm) Standard Blade
EQ8LB	8" (204 mm) Standard Blade
EQ12LB	12" (305 mm) Standard Blade

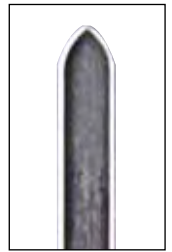

CRL Equalizer® Serrated Edge Reciprocal Blades

- Double Serration for Faster Cutting
- Fits All Equalizer® Reciprocal Tools

These Equalizer® Blades have a double serrated edge for faster cutting. They fit in all Equalizer® Reciprocating Tools, including Magnum, Freedom, and Excalibur, and must be used inside the Stainless Steel Sheaths shown below.



CAT. NO.	DESCRIPTION
ESB1304	4" (102 mm) Serrated Blade
ESB1308	8" (204 mm) Serrated Blade
ESB1312	12" (305 mm) Serrated Blade



Blades shown on this page are not warranted against breakage. The blades are made from tempered steel that is strong but brittle, and will break if flexed to an extreme.

CRL Equalizer® Reciprocal Blade Sheaths

- Adjustable for Cutting Depth
- Work with All Equalizer® Blades Above

These Equalizer® Sheaths are used with Equalizer® Standard Edge and Serrated Edge Reciprocal Blades. They help protect the dash and pillars from blade damage as the tips cut out the adhesive. You can adjust the exposed blade length to accommodate different widths of urethane bead.



CAT. NO.	DESCRIPTION
EQ4SS	Sheath for 4" (102 mm) Blades
EQ8SS	Sheath for 8" (204 mm) Blades
EQ12SS	Sheath for 12" (305 mm) Blades

CRL Equalizer® Sheath Cleaner

- Clean Sheaths Help Keep Your Equalizer® Tool Running Great
- Removes Build-up

The CRL Equalizer® Sheath Cleaning Container will keep your Equalizer® Tool operating at top performance. Urethane and butyl should not be allowed to build up inside the sheaths of your CRL Equalizer® Tool. This build-up can put excess strain on the drive unit. We recommend using CRL2032 General Purpose Solvent and Adhesive Cleaner for soaking the sheaths.



CAT. NO. ESC780

CRL General Purpose Solvent and Adhesive Cleaner

- Extra Strength for Use on Tough to Remove Urethane Adhesive

CRL General Purpose Solvent and Adhesive Cleaner handles some of the toughest cleaning jobs your shop can encounter. Use CRL2032 to soften and remove uncured urethane adhesives, tar, grease, oil, body sealer, and undercoating. Apply to a rag and rub lightly over soiled areas, then wipe up with a clean, dry cloth. **NOTE:** Use only per printed instructions.

CAT. NO.	CONTENTS
CRL2032	32 Fl. Oz. (946 ml)



CRL Pumper

- Helps Prevent Neck Injuries
- Speeds Glass Removal



CRL Pumper is a tough, vinyl-encased bag that, when placed between the windshield and the body, prevents pushing out the glass with your head and shoulders, which can lead to injuries. Produces up to 200 pounds of constant pressure to push the glass out allowing you to easily cut through the urethane.

The Pumper is best when used in pairs. Made in the U.S.A.

CAT. NO. LB779

CRL Neck Saver

- Holds Glass from Pillar to Speed Removal Process



Never use your head to push the windshield out. The CRL Neck Saver can prevent injuries by lifting the windshield as it is cut away. This not only exposes the urethane bead along the dash area, but also stresses the urethane for easier cutting. Neck Saver is sold only in pairs.

CAT. NO. 19NS

CRL Mechanix M-Pact Gloves

- The Tool that Fits Like a Glove
- Reduces Injury from Vibrating Tools



CRL Mechanix M-Pact Gloves have additional padding and gel-filled patches on the palm area to absorb the vibrations from power tools and impact tools. They fit your hands so well, its like you're not wearing gloves at all. See our complete line of safety gloves on page A388 through A391.

CAT. NO.	DESCRIPTION
MP010	M-Pact Gloves - Large
MP011	M-Pact Gloves - X-Large
MP012	M-Pact Gloves - XX Large

CRL Slip-N-Grip® Seat Covers

- Protect Your Customer's Seats for Pennies Each

These CRL Slip-N-Grip® Seat Covers can save you the cost of cleaning soiled or urethane stained seats. Disposable CRL Slip-N-Grip® Covers have a unique two-sided design that clings to the seat without slipping, protecting the interior of your customer's vehicle. The 33" by 56" (83 cm by 142 cm) size fits virtually any seat. 250 large ready-to-use covers per dispenser box. Minimum order is one box.

CAT. NO.	SIZE	QTY/BOX
600088	33" x 56" (83 x 142 cm)	250



CRL Slip-N-Grip® Value Floor Mats

new

- Made of Tough Plastic, Not Paper

CRL Slip-N-Grip® Floor Mats can save you the cost of cleaning soiled or urethane stained floor mats. Economical to use CRL Slip-N-Grip® Floor Mats have a two-ply design that stays put to protect the interior of your customer's vehicle. 500 mats per roll. Minimum order is one roll.

CAT. NO.	SIZE	QTY/ROLL
6000721	19" x 21" (48 cm x 53 cm)	500



CRL Slip-N-Grip® Steering Wheel Covers

new

- Protects Steering Wheels from Drips and Spills

CRL Slip-N-Grip® Steering Wheel Covers protects steering wheels from grease, dirt, and spills that are inevitable when installing glass. The universal-fit covers easily slip over the steering wheel with elastic which also keeps them in place. Keep your customers happy and show them you care with a professional job well done. Minimum order is one box.

CAT. NO.	QTY/BOX
600099	250



CRL Heavy-Duty Car Protectors

- High Grade Rubber Backing
- Protects Against Drips and Scratches

Protect your customer's vehicle while replacing windshields and backlights. Spread out our CRL Heavy-Duty Car Protectors on the hood or trunk to protect against drips, scratches, and scrapes from tools or supplies. All three sizes are made with a high-grade rubber backing on the special fabric to keep it from slipping. A double stitched hem all the way around protects from fraying. Can be rolled up for storage.



CAT. NO.	DESCRIPTION	SIZE
306	Large Protector	90" x 27" (228 x 68 cm)
307	Standard Protector	70" x 27" (178 x 68 cm)
308	Small Protector	54" x 30" (137 x 76 cm)

CRL Radians® Glasses

- Scratch and Fog Resistant
- Complete with Neck Cord and Ear Plugs



CAT. NO. AV1110
Radians® AV Glasses



CAT. NO. SA2110
Radians® Sabre Glasses

CRL Radians® Glasses offer the best in eye and ear protection in one. Developed for the construction industry, these unique safety glasses employ the unique feature of having built-in earplugs. The Lens has an anti-scratch hard coating, and has 99% UV protection that meets or exceeds ANSI standards. They also resist fogging in all types of weather and working conditions. Each pair of CRL Radians® Glasses come complete with a neck cord to hold them while not in use. The ear protectors are reusable, washable, and conveniently replaceable.

CRL Economy Hood Protectors

- Available with Your Company Logo
- Washable, Non-Slip Vinyl

When you're working on a customer's vehicle, you don't want it damaged. These extra large 70" x 27" (178 x 68 cm) Economy Hood Protectors give the hood and fender maximum protection against spills and scrapes. They are made with a rubber backing so they won't slip off while you're working. Washable vinyl material is also grease resistant.



CAT. NO. HP5470

CUSTOM IMPRINT AVAILABLE

CRL Economy Hood Protectors are also available with your custom imprint. We can put your logo, phone number, or web address on each protector, and our minimum order is only 144 pieces. Choose between black or blue color material, with a white ink imprint. Maximum imprint size is 18" wide x 12" high (45 x 30 cm), and a drawing will be required with the order. For more details and pricing, please contact CRL Customer Service.

CRL Multi-Purpose Emergency Escape Tool

- Breaks Out Side Window and Cuts Seat Belts
- Every Glove Box Should Have One



CAT. NO. EDMP1

CRL's Multi-Purpose Emergency Escape Tool has a protected razor sharp retractable knife that can cut the seat belt loose in one motion, and a compact hammer with a sharp carbide steel point that can shatter windows for a quick escape. There's even a small battery powered light built into the handle to aid in visibility. Every car should have one in the glove box.

See our complete listing of safety clothing and supplies on pages A388 through A396.



CRL Glass Handler Kit

- Allows One Man to Set Large Windshields
- Includes Two Pump-Actuated Vacuum Cups

The CRL Glass Handler Kit is the ultimate tool for setting auto glass. Ergonomic handle design allows for easier sets without strain on arms and back. Foam elbow pad rests on hood/cowl area for pivot point, which reduces back strain. Step-by-step instruction video included.



CAT. NO. K1T1710



The Glass Handler Kit contains: Two 6" (152 mm) diameter Pump-Actuated Vacuum Cups, Foam Block Elbow Pad, Suction Cup Lubrication, and an Instruction Video, all packed in a sturdy Plastic Carrying Case.

CRL Lexan Vacuum Cup

- Lightweight Yet Powerful Gripping Strength

Our Lexan Vacuum Cup is lightweight yet tough, and its 4-1/2" (114 mm) diameter rubber pad can develop up to 80 pounds of attaching pressure when applied to smooth, non-porous surfaces. Place it firmly against the glass; flip up the handle actuator and lift. It's that quick and easy!



CAT. NO. V1702

CRL Wood's Handi-Grip Vacuum Cup

- 3" by 6" Oval Shaped Cup for Long or Narrow Objects



CAT. NO. RF36HG

The Wood's Handi-Grip Vacuum Cup is designed for handling small to moderate size loads of glass, sheet metal, and plastic. The 3" by 6" (76 by 152 mm) oval shape allows for attachment on long, narrow objects such as mirror strips. Finger grip aluminum "T" handle sits atop a reliable Wood's hand-actuated pump for sure holding power. Lift tabs on edges of pad permit instant release. NOTE: Rated for a maximum safe load of 40 pounds (18 kg).

CRL Single Lever Lightweight Vacuum Cup

- Compact Design
- Large Capacity



CAT. NO. 6000VB

Our lightweight Single Lever Vacuum Cup is easy to attach with its split handle design. The 4-1/2" (114 mm) diameter cup develops up to 66 pounds of lifting power, making it, for its weight, one of the highest capacity cups available. Cup will adhere to any smooth, non-porous surface such as glass, mirror, steel, aluminum, laminates, and plastics. Its durable metal construction and hard coating make it tough enough for everyday use. A simple, reliable, easy to use vacuum cup.

CRL Glass Jack

- Adjustable for Perfect Alignment of Heavy Windshields



CAT. NO. J1

Although the CRL Glass Jack was developed for setting mirrors and float glass it also can be used for setting large windshields without stops. The Glass Jack's adjustability allows for a perfect alignment of the windshield with ease. NOTE: Requires CRL Wood's 8" Powr-Grip Vacuum Cup, which must be ordered separately.



CRL Wood's Powr-Grip 6" Vertical Handle Vacuum Cup

- All Metal Handle and Pump
- Handle Position is Ideal for Use with Windshields
- Red Warning Indicator Warns of Low Vacuum

The CRL Wood's Powr-Grip 6" Vertical Handle Vacuum Cup has a semi-concave rubber cup which is excellent for handling curved surfaces such as windshields. The flexible cup conforms to the surface then flattens out, providing maximum gripping power. This 6" (152 mm) cup uses the same plunger as the Wood's W4950, respected worldwide in the flat glass industry. A plastic cover is included to protect the rubber. The W6100 is a must for anyone in the automotive windshield replacement business.



CAT. NO. W6100

CRL Wood's Powr-Grip 6" Rigid Handle Flat Surface Vacuum Cup

- Lightweight and Portable
- Makes Handling Glass Easier and Safer

This rigid handle CRL Wood's Vacuum Cup has an all-aluminum casting which incorporates the pump housing and handle together for strength and protection for the pump. The 6" (152 mm) Powr-Grip Cup can handle most of the loads of larger cups. The size makes this product easy to carry in a larger pocket or small tool box. The rubber cup has a dual seal system to protect against vacuum loss. A plastic cover is included for protection against cuts and nicks.



CAT. NO. W6200

CRL Wood's Powr-Grip 6" Flip Handle Vacuum Cup

- Compact, Lightweight, and Portable
- Famous Wood's Pump Reliability

This CRL Wood's Powr-Grip 6" Flip Handle Vacuum Cup has an all-aluminum casting which incorporates the pump housing, and serves as a base for the 'flip' handle. The 6" (152 mm) Powr-Grip Cup can handle much of the load capacity of larger cups, but in a compact size that's just right for your tool box. The rubber cup has a dual seal system to protect against vacuum loss. A plastic cover is included for protection against cuts and nicks.



CAT. NO. W6300

CRL All Rubber 6" Auto Vacuum Cup

- The Perfect Tool for Handling Curved Windshields and Backlites

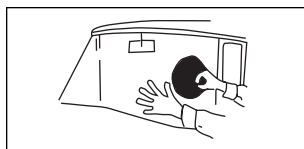

CAT. NO. CRL69

The CRL All Rubber Auto Vacuum Cup provides the installer with the easiest way to handle windshields and backlites. They fit the contour of bent windshields and backlites to allow you to maneuver the glass into place, thus eliminating the possibility of breakage by hitting the glass. Diameter of cup is 6" (152 mm).

CRL Automotive Suction Cups

- Ideal for Dent Removal, or Sheet Metal and Flat Panel Handling



CAT. NO. VC81810



CAT. NO. 77131

CRL Automotive Suction Cups are ideal for auto glass shops. You can use them for many jobs, such as pulling out panel dents and lifting sheet metal, glass or plastic. The steel bar handle swivels and flexes, and will permit pulls with a chain, jack or other such methods. Thick rubber pad gives long life and strong gripping power.

CAT. NO.	DESCRIPTION
VC81810	6" (152 mm) Automotive Suction Cup
77131	8" (203 mm) Automotive Suction Cup

CRL Windshield Hold-Down Vacuum Cup Set

- Movable Pads Conform to Contours **new**
- Secures Windshield and Molding

The CRL Windshield Hold-Down Vacuum Cup Set is a complete system that firmly secures both the windshield and the molding during the adhesive curing process. Once you use the Vacuum Cups to position the glass you thread the Tie-Down Strap through the slits in the handles. Then the strap is pulled around the "A" Pillar on one side of the vehicle, and around the opposite "A" Pillar back to the surface of the windshield. From there it is threaded into the ratchet mechanism and tightened, holding both the glass and molding in place while the adhesive cures.

The vacuum cups are 4-5/8" (117 mm) in diameter, and the handles have swivel points so the cups can conform to curved windshields or flat glass surfaces. The set contains two Double Swivel Vacuum Cups, and one 13 foot (4 meter) Ratcheting Tie-Down Strap.



Slots for Tie-Down Strap

CAT. NO. VCS2

CRL Double Swivel Vacuum Cup

- Double Vacuum Pads for Secure Grip
- Approximately 150 Lbs. Lifting Capacity



CAT. NO. 911VC

The CRL Double Swivel Vacuum Cup is specially designed for lifting, positioning, and fitting of windshields or truck and bus glass. The strong plastic body has double swivel points to allow fast attachment to a wide variety of curved and flat surfaces. Rubber pads are a big 4-3/4" (121 mm) in diameter.

CRL Rubber Conditioning Glycerine

- Preserves Your Vacuum Cups
- Prevents Premature Aging and Cracking

CRL Rubber Conditioning Glycerine preserves your vacuum cup and helps keep it from failing. Vacuum cup rubbers should be occasionally wiped clean with glycerine and stored in a safe storage location. Surplus glycerine should be wiped off to prevent slipping. Glycerine is a must have product for anyone who owns a vacuum cup. 16 Fl. Oz. (473 ml).



CAT. NO. GL22

CRL Auto Glass Setting Stick™



- Allows You to Set Windshields and Back Glasses by Yourself **new**

CAT. NO. HST212

There are times when you have to set a windshield by yourself because an extra set of hands is not available. Now one person can easily install a windshield without worrying about setting it properly. Developed by an auto glass technician, the Auto Glass Setting Stick™ sits over the windshield wiper post on the bottom. It can also be used when setting back glasses by placing its non-skid pad against the body. The pad is also useful when the wiper post is not in the right location. The top is held above the car with a non-skid rubber pad that keeps the Auto Glass Setting Stick™ elevated. Stick measures 48" (122 cm) long to accommodate even large windshields.



Set the glass on the peg at the bottom of the Auto Glass Setting Stick™. It is held in place while you put your side where you want it.



After setting your side, walk to the other side, lift the stick up a small amount and slide the Auto Glass Setting Stick™ out of the way.



Set the Auto Glass Setting Stick™ out of the way and you are now ready to place the glass in position.



LOG ON TO crlaurence.com FOR BUSINESS-TO-BUSINESS SERVICES

A206 | PHONE (800) 421-6144 | FAX (800) 262-3299 TOLL FREE FROM ANYWHERE IN THE U.S.A. OR CANADA

CRL Folding Windshield Stands



- These Easily Transportable and Very Sturdy Stands Are Now Available in Two Sizes

These easily transportable, sturdy metal stands are designed for mobile or in-shop use. Each stand provides a working platform to support windshields for sealant application. Our Large Windshield Stand measures a full 46" (117 cm) wide to handle today's larger windshields. Also available for the Regular 26-1/2" (67 cm) wide Windshield Stand is a 30" by 24" (76 by 61 cm) Carpeted Table Top to convert the stand to a portable work table for your supplies and tools.



CAT. NO. FWS11
Large Size Windshield Stand



CAT. NO. FWS10
Regular Size
Windshield Stand

CAT. NO. FWST
Carpeted
Table Top

CAT. NO.	DESCRIPTION
FWS11	Large Windshield Stand ★
FWS10	Regular Windshield Stand ▲
FWST	Carpeted Table Top for FWS10 ▲

*Must ship common carrier. ▲ Can be shipped U.P.S.

- Made by CRL in the U.S.A.

CRL Portable Windshield Stand

- Strong-Holds Up to 500 Pounds
- Lightweight-Weighs Just 16 Pounds
- Foam Padding Protects Glass
- Adjustable Height from 33" to 44"
- Assembles Easily in Minutes
- Folds to Just 4" Thick

Our WS85 Portable Windshield Stand will support even the largest windshield or back glass while you apply your urethane adhesive and primers. Constructed of steel tubing with 1/2" (12 mm) foam padding on top, this lightweight yet strong stand will hold up to 500 pounds (226 kg). Measures a big 40" (101.6 cm) wide, with an adjustable height from 33" to 44" (83.8 to 111.8 cm), and will fold to just 4" (10 cm) thick for easy storage. Ships economically via U.P.S., and is very easy to assemble. Also available is a 30" by 24" (76 by 61 cm) Carpeted Table Top to convert the Stand to a portable work table for your tools and supplies.



CAT. NO. WS85
Portable Windshield Stand



Shown with
Optional Carpeted
Table Top

CAT. NO.	DESCRIPTION
WS85	Portable Windshield Stand
FWST	Carpeted Table Top for WS85

CRL Folding Work Seat

- Large 12" x 12" (30.5 by 30.5 cm) Heavy Canvas Seat
- Strong Tubular Legs
- Compact Design

Convenience and strength are the hallmarks of the CRL Folding Work Seat. This handy, portable seat is designed to go anywhere you need a seat. Fold it up and put it in your tool chest or behind the seat of your truck. It is compact and rugged, featuring four strong, tubular alloy legs and a heavy canvas seat. The seat stands 16" (40.6 cm) high assembled, and comes with a convenient carrying strap. Great for work or leisure.



CAT. NO. CRL197



CRL Mobile Auto Glass Racks

new

- Mounts in the Bed of Your Truck
- Standard 19" Masts Hold Larger Windshields
- Adjustable Grips for Safe, Secure Transport
- All Glass Areas Have Rubber Pads to Help Prevent Breakage During Transport
- Heavy Gauge Steel With Weather Resistant Black Powder-Coat Finish



Both WR5 5-Lite and WR9 9-Lite CRL Mobile Auto Glass Racks assemble easily for fast pickup truck bed installation. The heavy steel powder-coated base holds the sponge rubber protected masts firmly to keep your windshield load steady. Adjustable grips press against the glass to prevent movement, and the rubber protective strips on the base plate ensures against glass breakage. Black powder-coat finish gives all-weather resistance. Masts are 19" (48.2 cm) high.

CAT. NO.	CAPACITY	LENGTH	WIDTH	HEIGHT	SHIP WT.
WR5	5 Lites	18" (45.7 cm)	30" (76.2 cm)	22-1/4" (56.5 cm)	27 lbs. (12.2 kg)
WR9	9 Lites	30-1/2" (77.4 cm)	30" (76.2 cm)	22-1/4" (56.5 cm)	50 lbs. (32.7 kg)

All Racks are F.O.B. the nearest CRL warehouse.

CRL Flat Rack Folding Glass Racks

new

- Provides Extra Room Quickly When Needed
- All Heavy-Duty Aluminum Construction

When you have the need to transport something large in your pickup bed, and still need a great windshield rack, the solution is the CRL Flat Rack Folding Glass Rack. Able to fold down in thirty seconds, this heavy-duty all aluminum rack is available in five and nine lite models. Four friction pins hold the masts in the vertical position, and when removed allow them to fold to the lowered position. Constructed with sturdy aluminum for a long work life with no paint chipping or rusting. Masts are 18-1/2" (47 cm) high.



CAT. NO.	CAPACITY	LENGTH	WIDTH	HEIGHT	SHIP WT.
LRW5	5 Lites	20-3/4" (52.7 cm)	30" (76.2 cm)	21" (53.3 cm)	20 lbs. (9 kg)
LRW9	9 Lites	32-3/4" (83.2 cm)	30" (76.2 cm)	21" (53.3 cm)	30 lbs. (13.6 kg)

All Racks are F.O.B. the nearest CRL warehouse.



CRL Rubber Donuts

- Custom Build Your Own Glass Caddy or Repair Your Old One



CAT. NO. 14779

CRL offers you a high quality Rubber Donut for use in making your own glass caddy or rack. They fit snugly over rods or dowels with a 1" (25.4 mm) diameter. Custom build your own windshield transportation mechanism to fit your specific needs. With CRL Rubber Donuts, you can be sure of safety in glass transportation. Measures 3" (76.2 mm) in diameter by 7/8" (22 mm) thick.

CRL Truck Rack Cushion

- Cushions Glass on Racks with Horizontal Slats

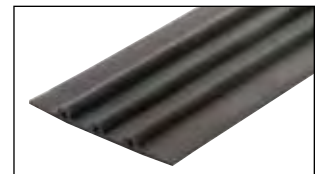

CRL Truck Rack Cushion is used on the horizontal slats of a glass rack. It cushions and prevents glass from slipping, and can be glued or tacked to glass racks. Must be ordered in increments of 12 feet.

CAT. NO.	COLOR	WIDTH	ROLL LENGTH
450TRC	Black	3-1/2" (89 mm)	12 Feet (3.66 m)



CRL Truck Bed Glass Carriers

- Mounts to Truck Bed in Just Minutes to Provide Safe and Reliable Glass Transportation
- Will Fit Any Size Pickup
- Versatile and Quick Loading

Truck Bed Glass Carriers are the affordable glass transporting system that's versatile and quick to load. There are three sizes that will fit in any pickup truck, domestic or imported. Windshields are held securely by the molded rubber bumpers with interlocking lower flanges that form a continuous resting area for the glass. Masts are 19-3/4" (50.1 cm) high. Vinyl sleeves cover pegs between bumpers, so there is no glass-to-metal contact. All steel construction, plus no moving parts to repair or replace, give you a carrier that will provide years of service.

NOTE: Mounting Bolts are included with all Racks. Specify truck year, make and model when ordering the WTR36F 36-Lite Carrier.



CAT. NO.	CAPACITY	LENGTH	WIDTH	HEIGHT	SHIPPING WT.
WTR5F	5 Lites	36-3/4" (93.3 cm)	29-1/2" (75 cm)	20-3/8" (51.7 cm)	40 lbs. (18.1 kg)
WTR10F	10 Lites	36-3/4" (93.3 cm)	29-1/2" (75 cm)	20-3/8" (51.7 cm)	54 lbs. (24.5 kg)
*WTR36F	36 Lites	79" (200.6 cm)	28" (71.1 cm)	21" (53.3 cm)	140 lbs. (63.5 kg)

* F.O.B. Tupelo, Mississippi. WTR5F and WTR10F will ship via UPS from the nearest CRL warehouse.

CRL Grommets for Truck Bed Glass Carriers

- Replacement Rubber Grommets for WTR Series Glass Carriers

These CRL Replacement Top or Bottom Grommets fit on your WTR Series Glass Carrier to cushion glass during transport.



CAT. NO. WTR10FBG
Bottom Grommet



CAT. NO. WTR10FTG
Top Grommet

CRL Bottom Rubber Strips for Truck Bed Glass Carriers

- Replacement Strips for 5-Lite and 10-Lite WTR Series Glass Carriers



CAT. NO.	RACK	LENGTH	WIDTH	THICKNESS
WTR5LRS	5 Lites	11" (279 mm)	7/8" (22.2 mm)	1/4" (6.3 mm)
WTR10LRS	10 Lites	21-1/4" (540 mm)	7/8" (22.2 mm)	1/4" (6.3 mm)

Sold only in pairs.

CRL Roll-Out Windshield Rack

- For Full Size or Compact Vans
- Complete with All Hardware

This CRL Roll-Out Windshield Rack easily mounts in compact and walk-in vans, and pickups. Holding up to 20 windshields, it slides for easy loading and unloading. Positive lock prevents movement during transport. Made of heavy gauge steel and painted white, it has thirty 7/8" (22.2 mm) diameter, rubber padded wood dowels.

NOTE: Year, make and model, and wheelbase of truck must be specified when ordering.

F.O.B. Milwaukee, Wisconsin. Boxed for shipping.

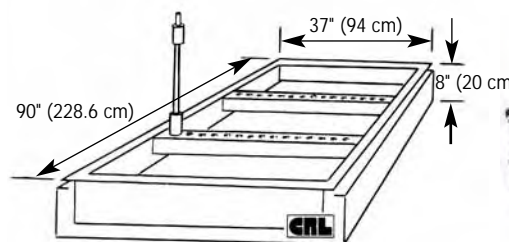

CAT. NO. BR5100

CRL Burco Redi Racks®

- Constructed of Heavy Gauge Steel with Weather Resistant Black Powder-Coat Finish
- All Glass Contact Areas Have Rubber Pads to Help Prevent Breakage



Burco Finger-Lock®

Each mast is topped by a Finger-Lock®, which has an open/close position to secure the glass in place for a more dependable hold.



These Burco Redi Racks® offer the best ride for your glass because all glass contact areas are protected by rubber pads to help prevent breakage. They're constructed of heavy gauge steel with a highly durable, black powder-coat finish for all-weather protection and low maintenance. 5-Lite or 9-Lite models have 15" (38.1 cm) masts placed 3" (7.6 cm) on center, and each has the proprietary Finger-Lock® to hold glass snugly. Both models come with a Slick Eddy® Glass Slide to ease loading and unloading of glass. Mast Extensions are also available to extend the height of individual masts to 36" (91.4 cm).

CAT. NO.	CAPACITY	LENGTH	WIDTH	HEIGHT	SHIPPING WT.	DESCRIPTION
S05B	5 Lites	18" (45.7 cm)	30" (76.2 cm)	18" (45.7 cm)	32 lbs. (14.5 kg)	5 Lite Redi Rack
S09B	9 Lites	30" (76.2 cm)	30" (76.2 cm)	18" (45.7 cm)	48 lbs. (21.8 kg)	9 Lite Redi Rack
SE46						Slick Eddy Glass Slide

Redi Racks® and accessories ship F.O.B. all CRL warehouses. Both sizes can ship UPS.

The Slick Eddy® Glass Slide that comes with every Redi Rack® makes loading and unloading windshields easier by reducing friction between the glass and the rubber base.



CRL Burco V-Rack

new

- Safe Transportation of Big Windshields
- Finger-Locks® Keep Loads Secure
- Storage and Transportation of Glass in Enclosed Vehicles Reduces Chance of Breakage

The CRL Burco V-Rack Carrier is designed with a step down base for upright transportation of windshields up to 47" (119 cm) high in a full-size van or enclosed pickup. As with the CRL Burco Redi Rack®, this rack incorporates Finger-Locks® to hold the glass snugly. Heavy gauge steel with durable black powder-coat finish for long-life durability. Mast heights range from 21" (53.3 cm) to 23" (58.4 cm).



CAT. NO.	CAPACITY	LENGTH	WIDTH	HEIGHT	SHIPPING WT.
V0924	9 Lites	30" (76.2 cm)	30" (76.2 cm)	24-1/2" (62.2 cm)	70 lbs. (31.8 kg)

Ships F.O.B. nearest CRL warehouse. Can ship via UPS.

Replacement Parts for CRL Burco Redi Racks®

new

Mast Extensions

- Extends Mast Height to 36" (91.4 cm)



CAT. NO. EX21

Mast Tubing

- Easy Slip On Replacement



CAT. NO.	TUBING LENGTH
RCT01	13-3/4" (34.9 cm)
RCT02	19-1/2" (49.5 cm)
RCT03	21-1/4" (54 cm)
RCT04	22-3/4" (57.8 cm)

Finger-Locks®

- Replace Worn or Damaged Originals



CAT. NO. RFL01

Rubber Base Pads

- Maintains Glass Protection



CAT. NO.	FITS
RBR05	S05B Redi Rack
RBR09	S09B Redi Rack
RBR09V	V0924 V-Rack



LOG ON TO crlaurence.com FOR BUSINESS-TO-BUSINESS SERVICES

A210 | PHONE (800) 421-6144 | FAX (800) 262-3299 TOLL FREE FROM ANYWHERE IN THE U.S.A. OR CANADA

CRL Freestanding Single-Sided Windshield Racks

- **Welded Steel Racks with Capacity for 36 or 45 Windshields or Backlites**

This CRL Single-Sided Windshield Rack is freestanding, making it easy to locate anywhere your shop has room. Both 36-Lite and 45-Lite models are made of welded steel, with wide bases to keep them steady, even under a heavy load. The steel masts have durable polyethylene covers with plastic caps, and there are neoprene glass stops on the uprights. Masts are 24" (61 cm) long. An enamel finish protects against rust. Assembly requires no special tools. All hardware and instructions are included.

CAT. NO.	CAPACITY	DEPTH	WIDTH	HEIGHT
WSSR36	36 Lites	41" (104 cm)	27" (68 cm)	77" (195 cm)
WSSR45	45 Lites	45" (114 cm)	27" (68 cm)	95" (241 cm)

Racks are shipped F.O.B. Tupelo, Mississippi.



CRL Freestanding Double-Sided Windshield Racks

- **Double the Capacity of Single Sided Racks**

CRL Double-Sided 72-Lite and 90-Lite Windshield Racks provide the most storage space possible in an area only slightly larger than that of a single-sided rack. The welded steel construction, polyethylene covered masts, corrosion resistant enamel finish, and sturdy base give you an efficient storage system that's easy to assemble or move as necessary. Masts are 24" (61 cm) long. Assembly requires no special tools, and all hardware and instructions are included.



CAT. NO.	CAPACITY	DEPTH	WIDTH	HEIGHT
WDSR72	72 Lites	72" (183 cm)	27" (68 cm)	78" (198 cm)
WDSR90	90 Lites	72" (183 cm)	27" (68 cm)	96" (244 cm)

Racks are shipped F.O.B. Tupelo, Mississippi.

CRL Wall Mount Windshield Rack

- **Holds Up to 45 Lites in a Minimum of Floor Space**

This CRL Wall Mounted Windshield Rack is the maximum in mast type storage systems. Polyethylene coated masts and neoprene backstops protect the glass, while the rack takes up a minimum of floor space. Although the rack is anchored to the wall, the legs place most of the weight on the floor. Masts are firmly welded in place and require no assembly. Masts are 24" (61 cm) long. A universal mounting kit is included.

NOTE: Consult a local building engineer and local building codes prior to installation.



CAT. NO.	CAPACITY	DEPTH	WIDTH	HEIGHT
WR45	45 Lites	25" (63 cm)	27" (68 cm)	108" (274 cm)

Racks are shipped F.O.B. Tupelo, Mississippi.

CRL Windshield Carts

- **Models for 15, 20, and 25 Lites are Available**



These CRL Windshield Carts make it easy for one person to move 15 to 25 windshields. Built of welded steel, with polyethylene-coated masts and neoprene stops to protect the glass. Masts are 19-3/4" (50.1 cm) high. Rides on ball bearing casters with toe locks. Hardware and assembly instructions are included.

CAT. NO.	CAPACITY	LENGTH	WIDTH	HEIGHT
WGC15	15 Lites	51-1/4" (130 cm)	27" (68 cm)	34-3/8" (87 cm)
WGC20	20 Lites	61-1/4" (155 cm)	27" (68 cm)	34-3/8" (87 cm)
WGC25	25 Lites	71-1/4" (181 cm)	27" (68 cm)	34-3/8" (87 cm)

Carts are shipped F.O.B. Tupelo, Mississippi.

CRL Ergonomic Windshield Carts

new

- **Designed to Reduce Back Fatigue**



Available in 15-Lite and 30-Lite capacity models, CRL Ergonomic Windshield Carts provide an elevated setting area with masts that pivot downward for easier loading and unloading. Masts are 19-3/4" (50.1 cm) high. 1/2" (12 mm) thick rubber setting strips with polyethylene mast sleeves and caps protect the glass. Rugged 6" by 2" (152 by 51 mm) ball bearing swivel casters with toe locks make moving the carts easy. Hardware and assembly instructions are included.

CAT. NO.	CAPACITY	LENGTH	WIDTH	HEIGHT
WGC15E	15 Lites	66" (167 cm)	33-3/8" (85 cm)	46" (117 cm)
WGC30E	30 Lites	66" (167 cm)	63-3/8" (161 cm)	46" (117 cm)

Carts are shipped F.O.B. Tupelo, Mississippi.

CRL Clear Vac Windshield Repair Systems

- A Tested, Professional Glass Repair Method for Auto Glass Technicians

The CRL Clear Vac Windshield Repair System is a high quality, easy-to-use system that saves the cost of windshield replacement by using the latest technology to repair bull's eye, daisy, star or combination breaks. The Clear Vac System provides a maximum vacuum within the break cavity to facilitate the injection of the resin to fill all of the cracks and fissures. An Injector Pump forces the resin into the break and allows you to monitor the repair from the inside of the vehicle.

You can visually inspect the repair in progress to ensure complete filling of the break. The result is a repair that is virtually invisible when cured, and meets or surpasses the requirements of insurance companies and vehicle inspection stations. Although each windshield with stone damage will be different, you can expect to find one of the following types, all of which require the same style of repair.



Bull's Eye

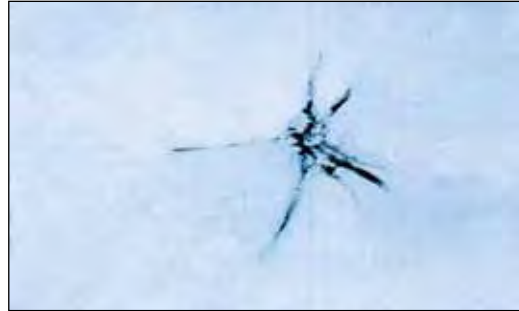

Star



Daisy

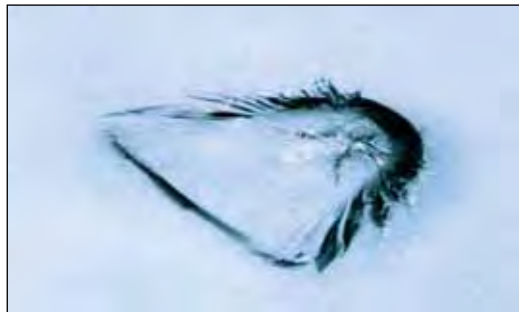

Combination

Preparing the Break



The first step in any repair is to make sure you have all of the components necessary to make the repair, and then to evaluate the damage. Most damaged areas must be cleaned of loose debris and glass particles with a scribe.



A recommended practice is to drill into the pit hole to allow resin to flow into the damaged cavity. You then repair the bull's eye break with resin, preventing the damages from going any further than the just repaired break.



Making a Professional Repair



Once the damage has been prepared for the repair, you will need to attach the repair fixture to the glass. Start by mounting a Cat. No. CSTR6 Alignment Seal directly over the damage.



The unique Pedestal Type Resin Chamber (Cat. No. CSP6) instantly adheres to the Alignment Seal accurately on center with the opening of the break cavity, forming a leak-proof bond.



The Resin is dispensed directly from the bottle into the Pedestal, which is made of nylon, providing a see-through feature that allows you to monitor the amount of Resin being dispensed.



The Injector Assembly has a special Flow Regulator that automatically controls and monitors the vacuum and pressure in the Resin Chamber during the repair process. It allows removal of all air pockets from the damaged area without extracting the Resin from the break cavity and chamber.



The well-engineered high vacuum Injector Assembly with dual action valve allows the technician to create a 29-3/4" Hg vacuum with just fingertip control, equivalent to a small power vacuum compressor.



The simplicity of the design allows repairs to be performed unattended. The technician is free to perform other tasks on the vehicle while the repair process is taking place. There's no standing around waiting for something to happen because it is self-attending.

To Summarize

The Clear Vac Repair Process is procedural, treating all windshield breaks the same, regardless of the type of break, and taking all of the judgment out of the repair process. The technician performs a vacuum step to remove the air in the break followed by a pressure cycle that does not require concentrated attention.

After trying the Clear Vac System one will quickly become familiar with the procedural repair process and understand the principals of windshield repair. Clear Vac Systems include all of the tools and materials needed to make high quality repairs, and allow you to begin making a profit while you provide a valuable service to your customers. For more information on Clear Vac Systems, turn to the following pages.



CRL Windshield Saver Kits

- Single and Five Packs Have Everything Necessary for a Complete Repair

The CRL Windshield Saver Kit uses a two-part epoxy compound to repair stone-damaged windshields. The compound hardens and bonds to fill chip crevices, preventing radial cracks. The clear epoxy will not affect visibility. Application is easy, and it's effective on a wide range of pit types, restoring the windshield to nearly new condition. Single application and five application packs contain everything necessary for a complete repair.



CAT. NO.	DESCRIPTION
WS341	Single Pack
WS345	Five Pack

CRL Clear Vac Windshield Repair System – 12 Pack

- Vacuum System Fills Cracks and Crevices Completely
- Cost Effective and Easy to Use

The CRL Clear Vac Windshield Repair System is a high quality, cost-effective alternative to replacing windshields with bull's-eyes or star breaks. This easy to use system saves the cost of windshield replacement by using the latest technology in glass repair, and opens a new source of profit for your business.

UV12 Kit Contains: Injector Pump with Flow Regulator, Two Clear Hoses, 12 Pedestals, 12 Alignment Seals, 12 Mylar Squares, One Each Bottle of UV Resin, Scraper, Single Edge Razor Blade and Holder, UV Curing Lamp (Batteries Included), Carbide Scribe, Instruction Booklet, and a Plastic Storage Case.



CAT. NO. UV12

CRL Clear Vac Mobile Kits – 24 Pack

- Self-Contained, Low Cost System for Effective Windshield Repairs
- Available With a 12V DC Drill or Without

Whether you are new to windshield repair or are an experienced technician, you should consider our Clear Vac Mobile Kits. They are sized for medium or large volume users, and provide everything you need to make professional repairs quick and easy. We also have Re-supply Kits and individual components for replenishing your Clear Vac Kits for the next job. Kits are available with a 12V DC Drill (Cat. No. UV24DX) or without (Cat. No. UV24X).

UV24X Kit Contains:

- 1 Injector Pump
 - 24 Adhesive Seals
 - 24 Pedestals
 - 1 Bottle of UV Resin (12 ml)
 - 2 Hoses with Connectors
 - 1 Flow Regulator
 - 1 Protective UV Shield
 - 1 Carbide Probe
 - 1 UV Curing Lamp
 - 4 AAA Batteries
 - 1 Battery Connector
 - 24 Mylar Squares
 - 1 Bottle of Pit Polish
 - 1 Razor Blade and Holder
 - 1 Windshield Temperature Gauge
 - 1 Clear Vac Instructional Video
 - 1 Instruction Manual
 - 1 Storage Box
- UV24DX Kit contains everything in the UV24X Kit plus:
- 1 High Speed 12 VDC Drill (12,000 rpm)
 - 2 Carbide Drill Bits



CAT. NO. UV24X
Kit without Drill



CAT. NO. UV24DX
Kit with Drill



CRL Clear Vac Windshield Repair Kit – 100 Pack

- A Full Service Kit for Shops Doing Lots of Repairs
- Contains Tools and Supplies to Fix Up to 100 Breaks

The CRL Clear Vac Windshield Repair System is a high quality, easy-to-use method that saves the cost of windshield replacement by using the latest technology to repair bull's-eye or star breaks. The Clear Vac System provides a maximum vacuum within the break cavity to facilitate the injection of the resin to fill all of the cracks and fissures. An Injector Pump forces the resin into the break and allows you to monitor the repair from the inside of the vehicle. You can visually inspect the repair in progress to ensure complete filling of the break. The result is a repair that is virtually invisible when cured, and meets or surpasses the requirements of insurance companies and vehicle inspection stations.

The SVD100 Kit Contains:

- | | |
|-------------------------------------|--|
| • Two Injector Pumps with Valve | • 1 Protective UV Guard |
| • 100 Pedestals | • 1 UV Curing Lamp (Batteries Included) |
| • 100 Alignment Seals | • 1 UV Curing Shop Lamp (110V AC) |
| • 1 Bottle of UV Quick Cure Resin | • 1 Drill (12,000 rpm) and Adaptor |
| • 1 Bottle of UV Crack Filler Resin | • 5 Carbide Drill Bits |
| • 1 Bottle of Pit Polish | • 10 Single Edge Razor Blades and Holder |
| • 3 Hoses | • 1 Carbide Scribe |
| • 2 Flow Regulators | • 4 AAA Batteries |
| • 25 Crack Resin Applicators | • 1 Instruction Manual |
| • 100 Mylar Squares | • 1 Storage Case |



CAT. NO. SVD100

CRL Clear Vac Re-Supply Kits

- Enough Supplies to Complete 24 or 48 Repairs
- Perfect for Restocking SVD100, UV24X or UV24DX Kits

CRL Clear Vac Re-Supply Kits are ideal for use with any CRL glass repair system that uses the Clear Vac Injector Assembly. This convenient Re-supply Pack comes equipped with all the components you need to complete 24 repairs, including replacement parts. A Re-Supply Pack that completes 48 repairs is also available.

All components contained in our Re-Supply Kits can also be purchased separately, and are shown on pages A216 to A217.

The SVR24 Re-Supply Kit Contains:

- 1 Bottle of UV Quick Cure Resin (12 ml)
- 24 Adhesive Alignment Seals
- 24 Pedestals (Resin Chamber)
- 1 Flow Regulator
- 1 Hose
- 24 Mylar Squares
- 1 Bottle of Pit Polish
- 1 Razor Blade and Holder
- 1 Instruction Sheet

The SVR48 Re-Supply Kit Contains:

- 1 Bottle of UV Quick Cure Resin (25 ml)
- 48 Adhesive Alignment Seals
- 48 Pedestals (Resin Chamber)
- 1 Flow Regulator
- 1 Hose
- 48 Mylar Squares
- 1 Bottle of Pit Polish
- 1 Razor Blade and Holder
- 1 Instruction Sheet



CAT. NO. SVR24
Completes 24 Repairs



CAT. NO. SVR48
Completes 48 Repairs

CRL Clear Vac Training Video

Our Clear Vac Training Video has lots of information that can make a difference in your glass repair results.

CAT. NO. VTCV1



CRL Replacement Alignment Seals

- For Use With CSP6 Pedestals

This pack of Alignment Seals for the Clear Vac System will re-supply your windshield repair kit with enough seals to do the next 25 repairs. Designed for use with any CRL Clear Vac Repair Kit.

NOTE: Clean repair area near fractures with Cat. No. CRL2032 Adhesive Cleaner if the windshield has hydrophobic coating.

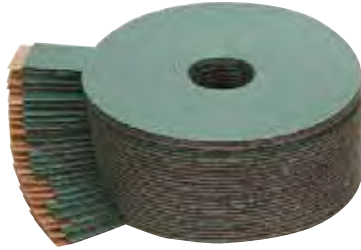

CAT. NO. CSTR6 Qty/Pkg 25

CRL Replacement Pedestals

- For Use With CSTR6 Alignment Seals

CRL Pedestals for the Clear Vac System will re-supply your windshield repair kit with pedestals for the next 25 repairs. These can be used with any CRL Clear Vac Repair Kit.



CAT. NO. CSP6 Qty/Pkg 25

CRL Flow Regulator

new

- Controls Resin Flow Into Repair
- Prevents Back Flow

This Flow Regulator maintains the correct flow of the Resin into the repair, and prevents back flow of the Resin into the hose during the vacuum cycle.



CAT. NO. FR1

CRL Cure Guard

new

- Shields Resin Chamber
- Allows Repairs in Direct Sunlight

By placing our Cure Guard over the Pedestal and Flow Regulator you can protect the Resin from curing in direct sunlight. An absolute must for making proper repairs outdoors.

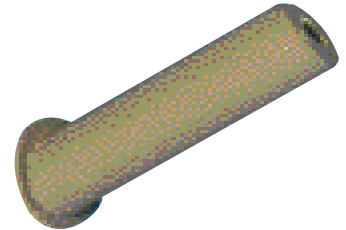

CAT. NO. CG1UV

CRL Clear Vac Injector Pump

- Used in All Clear Vac Kits
- Provides Pressure and Vacuum for Repairs
- Calibrated for Ease of Use



CAT. NO. EM60

The Injector Pump used in all CRL Clear Vac Repair Kits forces the Resin into the break and allows you to monitor the repair from the inside of the vehicle. You can visually inspect the repair in progress to ensure complete filling of the break. The barrel of the Injector is calibrated so you can monitor the correct amount of Resin for your repairs.

CRL Injector Maintenance Kit

new

- Removes Loose Seals from Bottom of Injector
- Cleans Injector

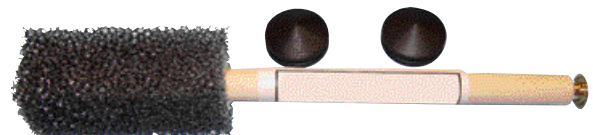

CAT. NO. 1BVMK

The CRL Injector Maintenance Kit performs two very important functions when working with our Injectors. Once the Injector becomes dirty the seal can pull free from the end of the plunger. The handle of the Cleaning Tool has a retrieval feature to capture the seal from the Injector. Use the soft foam end of the Cleaning Tool to clean the interior of the Injector. Add a shot of our Cat. No. PR02 Silicone Spray to the plunger seal to lubricate the seal within the barrel.



CRL Quick Cure UV Resin

- Medium Viscosity for Most Types of Breaks
- Rapidly Fills Large Voids

CRL Medium Viscosity Windshield Resin provides the easy flowing features that result in high quality chip repairs. The 25 ml bottle performs 70 to 100 repairs; get 35 to 50 repairs from the 12 ml bottle. Can be used with all CRL Clear Vac Repair Kit Injectors.



CRL Pit Fill UV Resin

new

- Heavy Viscosity, Fast Cure Formula for Vertical Surfaces
- Ideal for Windshields in RV's, Buses, and Heavy Equipment

CRL Pit Fill Resin is thicker to quickly fill the pit for completing the repair. Ideal for vertical glass surfaces, such as the glass found in buses, RV's, and heavy equipment. Get 35 to 50 repairs from the 12 ml bottle. Use our CRL10 Plastic Polish on the cured Resin to bring the repair to the best possible clarity.



CAT. NO. PFCH12 (12 ml)

CRL Glass-Temp Surface Temperature Gauge

new

- Checks Temperature of Windshield Before Application of Resins
- Helps Prevent Sub-Standard Repairs



CAT. NO. GT72

The CRL Glass-Temp Surface Temperature Gauge helps technicians avoid potential repair problems caused by excessive temperature conditions. Extreme hot and cold weather affect windshield structural integrity that may cause cracking or sub-standard quality repairs. Since windshields absorb both hot and cold temperatures, surfaces are significantly different than the air temperature registered on standard outdoor thermometers.

Glass-Temp mounts quickly and easily to give you the temperature of the windshield surface. It uses liquid crystal technology for its accurate and easy to read display.

CRL Windshield Crack Repair Resin

- Low Viscosity, Easy Flowing Formula for the Repair of Cracks



CAT. NO. CCH12 (12 ml)

CAT. NO. CCH1 (25 ml)

CRL Windshield Crack Repair Resin has exceptional cure speed and bonding strength to fill cracks that emanate from typical stone chip breaks. The low viscosity of this Resin makes it perfect for filling these cracks. You can use either natural or artificial ultraviolet light to cure this Resin. It's part of our CRL Crack Pack for repairing cracks in windshields (see below). The 25 ml bottle of Crack Repair Resin repairs approximately 70 to 100 cracks. It is packed in a sealed bottle and pouch to protect it until ready to use.

CRL Crack Pack Repair System

new

- Everything You Need to Repair Cracks that Emanate from Typical Stone Chip Breaks



CAT. NO. CP1

The CRL Clear Vac Crack Pack allows you to repair small stress cracks in windshields that emanate from typical stone chip type breaks. These cracks start out small, but can quickly spread across an entire windshield unless something is done to stop them. The Crack Pack includes the tools and instructions to perform small crack repair before the windshield is damaged beyond repair.

The Crack Pack Includes: 12 ml Bottle of Crack Filler Resin, 25 Resin Applicators, Miniature Bull's Eye Maker, Five Drill Bits, 50 Mylar Squares, 1/4 Oz. Bottle of Pit Polish, Razor Blade and Holder, and an Instruction Sheet. **NOTE:** A UV Curing Lamp and a Clear Vac Windshield Repair Kit are required to complete the repair.

CRL Aegis® Deluxe Windshield Repair Kit

- The Optimum Kit for the High Volume Shop
- Enough Equipment to Do Two Repairs at Once

The CRL Aegis® Deluxe Windshield Repair Kit is for serious glass professionals that demand serious equipment. The Deluxe Kit has a rugged stainless steel and aluminum pump assembly that precisely displays pressure and vacuum cycle readings. There are two fixtures and adapter assemblies, allowing you to perform multiple repairs at once. That means you can double your productivity – and your profits. Everything listed below comes in a hard wall carrying case. Choose from 'AA' Battery or 12V DC UV Lamps.

- The Deluxe Kit Contains:
- Heavy-Duty Stainless Steel/ Aluminum Pump
 - Two Repair Fixtures
 - Two Adapter Assemblies
 - Resin for Up to 150 Repairs
 - UV Curing Lamp
 - Lamp Holder
 - Two Inspection Mirrors
 - Two Cleaning Brushes
 - Glycerine
 - Small (3/16") and Standard (3/8") Fixture Chambers
 - Penlight
 - Hose Assembly
 - Pit Fill Kit
 - Cordless Drill with Charger and Burrs
 - Supply Box (Filled)
 - Training Manual and Video



CAT. NO. K1T1050
UV Lamp Operates on AA Batteries

CAT. NO. K1T1051
UV Lamp Operates on 12V DC Source

CRL Aegis® Standard Windshield Repair Kit

- The Same Features as the Deluxe Kit at an Even More Attractive Price for Medium Volume Shops

The CRL Aegis® Standard Windshield Repair Kit is the standard among glass professionals. You get many of the same features included with the Deluxe Kit at an even more attractive price. Plus enjoy the convenience of the lever-style pump, allowing one-handed operation during the pressure/vacuum cycles. See for yourself why it's one of the best-selling professional kits on the market. Choose from 'AA' Battery or 12V DC UV Lamps.

- The Standard Kit Contains:
- Lever-style Pump
 - Repair Fixture and Chamber
 - Resin for Up to 150 Repairs
 - UV Curing Lamp
 - Lamp Holder
 - Inspection Mirror
 - Cleaning Brushes
 - Glycerine
 - Penlight
 - Hose Assembly
 - Pit Polish
 - Cordless Drill with Charger and Burrs
 - Supply Box (Filled)
 - Training Manual and Video
 - Hard Wall Carrying Case



CAT. NO. K1T1000
UV Lamp Operates on AA Batteries

CAT. NO. K1T1001
UV Lamp Operates on 12V DC Source

CRL Aegis® Pit Fill Kit

- Makes Repairs Practically Undetectable to the Touch

CRL Pit Fill Resin makes your repairs practically undetectable to the touch. Filling eliminates the pit that can occur after you complete a repair. Thicker and harder than polymer or crack filler, our pit filler also eliminates the water trail caused by a large pit during wiper usage.

The Pit Fill Kit contains a 2-milliliter Bottle of Resin, 100 Mylar Squares in a Magnifier Box, Needle, Syringe, Razor Blade, and Pit Polish.



CAT. NO. K1T1030

CRL Aegis® Video



CAT. NO. V1D2004

The new Aegis® Training Video covers basic use and maintenance of your Aegis® Repair Kits, plus special techniques for better results.



CRL Aegis® Advantage Windshield Repair Kit

• High Quality Aegis® Equipment for Smaller Shops

Lower volume repairs doesn't mean you have to settle for lower quality equipment. Quality construction is evident throughout the CRL Aegis® Advantage Kit. Included is the sturdy pro-series fixture and fully gauged pressure/vacuum pump. Plus, you can go cordless thanks to the battery-powered combination ultraviolet curing lamp/flashlight. The Advantage Kit gives you easy to afford, easy to achieve professional results.

The Advantage Kit Contains:

- Aluminum Pump
- Repair Fixture and Chamber
- UV Curing Lamp/Flashlight
- Resin for Up to 100 Repairs
- Hose Assembly
- Glycerine
- Inspection Mirror
- Supply Box (Filled)
- Training Manual and Video
- Hard Wall Carrying Case



CAT. NO. K1T1500

CRL Aegis® Quik Kit for Windshield Repair

new

• The Most Affordable Aegis® Kit Makes Quick, Easy Repairs

Three words say it all: Fast, Affordable, and Professional. The Aegis® Quik Kit fixture's fast setup saves both steps and time. And because it's so affordable, the Quik Kit allows expansion into professional-quality windshield repair with only minimal investment. And thanks to the generous supply of resin included, the kit can pay for itself before you need to restock.

The Quik Kit Contains:

- Pump
- Repair Fixture and Chamber
- UV Curing Lamp/Flashlight
- Resin for Up to 50 Repairs
- Hose Assembly
- Glycerine
- Supplies (Mylar Squares, Razor Blades, Syringes, Needles, Quad Rings)
- Instructions
- Plastic Carrying Case



CAT. NO. K1T1650

CRL Aegis® Long Crack Repair Kit

• Specifically Designed for the Repair of Long Cracks

The CRL Aegis® Long Crack Repair Kit is specifically designed for the repair of the long cracks that emanate from typical windshield breaks. Includes special Low Viscosity Resin to flow into cracks.

The Long Crack Kit Contains:

- Low Viscosity Crack Filler Resin
- Crack Expander
- Syringe
- Needle
- 3" Mylar Strips
- Razor Blade
- Glycerine



CAT. NO. K1T1036

CRL Aegis® Long Crack Tape

• Speeds Crack Repairs

Long Crack Tape speeds the crack repair process by preventing pressure loss when injecting resin into the crevice.

Must be removed for application of Mylar Squares for curing. 100 each 3" (76.2 mm) strips of tape per pack.



CAT. NO. HDW3010

CRL Aegis® Resin Injector Syringes

Use these CRL Aegis® Resin Injector Syringes to easily load your fixture with the resin. No more fumbling with small bottles, just load the resin into the Syringe and with the needle attached, insert into fixture opening and inject. Can be reused if kept out of sun or ultraviolet light. Six Syringes and three Needles per pack.

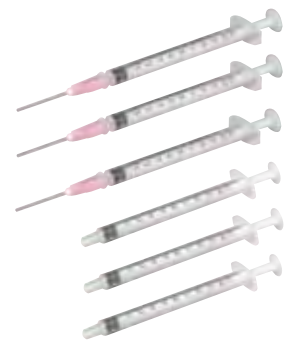

CAT. NO. SBX2030

CRL Aegis® Resin Polymer - Medium Viscosity

- New and Improved Formula
- Repairs Approximately 25 Breaks

New CRL Aegis® Medium Viscosity Resin Polymer is engineered specifically for bull's eye breaks. This improved formula does not bubble, and is environmentally friendly. Each 4 milliliter bottle repairs up to 25 breaks. Mylar Squares are required for a proper cure. Unopened shelf life is approximately two years.



CAT. NO. L1Q2010

CRL Aegis® Resin Polymer - Low Viscosity

- Repairs Approximately 25 Breaks
- Flows Easily Into Cracks

Special low viscosity formula CRL Aegis® Resin Polymer is the perfect choice for star breaks, combinations, and long cracks. Each 4 milliliter bottle contains enough crack filler for up to 25 repairs. Mylar Squares or Long Crack Tape is required for a proper cure. Unopened shelf life is approximately two years.



CAT. NO. L1Q2015

CRL Aegis® Mylar Squares

- Cut Specifically for Windshield Repairs
- Speeds Resin Curing Process

These CRL Aegis® Mylar Squares are required for curing windshield repair resins, and can be used with any windshield repair kit or resin. They are precut to 1-1/4" (31 mm) squares. 100 Squares per pack.



CAT. NO. HDW3000

CRL Aegis® Inspection Cup with Mirror

new

- Monitor the Repair from the Outside

The CRL Aegis® Inspection Cup with Mirror lets you monitor the repair process from your work area instead of repeatedly climbing in and out of the vehicle. Just place inside, directly opposite the break. Also blocks UV light from entering the glass from the opposite side of the repair.



CAT. NO. M1R2000

CRL Aegis® Quad Rings

- For Sealing Aegis® Fixture Chambers

CRL stocks the most common Quad Rings required for replacement with your Aegis® Kits. Choose from the 3/16" or 3/8" Aegis® Quad Ring depending on what system and Aegis® Fixture Chamber you have. Five Rings per pack.



CAT. NO. SBX2016



CAT. NO. SBX2010

CAT. NO.	SIZE
SBX2016	3/16" (4.8 mm) Rings
SBX2010	3/8" (9.5 mm) Rings

CRL Aegis® 3/16" Fixture Chamber

- Fixture for Use with Pre-1999 Aegis® Advantage Kits

A major component of your repair equipment, the Fixture Chamber screws onto the foot of the repair fixture and against the windshield to seal the impact point. The chamber holds a reusable quad ring to create the seal (one included, replacements sold separately). **NOTE:** This fixture is compatible only with unmodified Pre-'99 Aegis® Advantage Kits.



CAT. NO. F1X2013

CRL Bull's Eye Maker Kit

- Perfect Bull's Eye Produced
- Let's You Practice This Tricky Process

CRL's Bull's Eye Maker Kit will elevate your windshield repairs to a professional level quicker and safer than practicing on your customer's vehicle. Our Bull's Eye Maker is easy to use by simply holding the rubber bands between your fingers and snapping the steel ball against the glass. The Kit consists of two steel balls, 20 rubber bands and four wires to help thread the steel balls onto the rubber bands.

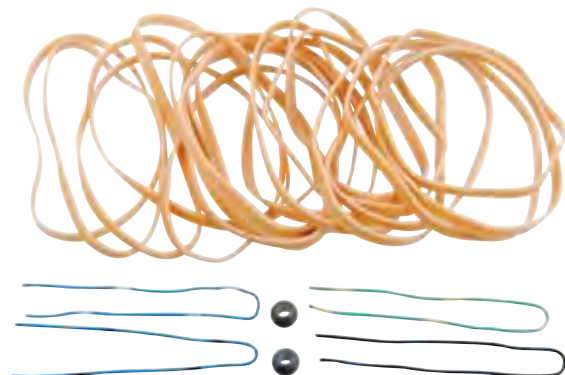

CAT. NO. 20SRK



CRL 115V AC Ultraviolet Curing Lamp

- For Curing Ultraviolet Resins and Adhesives
- Vacuum Cups for Mounting to Glass
- Lightweight and Durable

Ultraviolet curing windshield repair resins cure faster and more uniformly when exposed to concentrated Ultraviolet light rays. This CRL 115V AC Ultraviolet Curing Lamp is a portable source of long wave U.V. light. It transmits the maximum U.V. light while screening out visible white light. Four built-in vacuum cups allow mounting to glass surface. Operates on 115V AC, 60 HZ, .2 Amps. Replacement bulbs are available by ordering Cat. No. UV240BULB (see below).



CAT. NO. UV240

CRL Battery Operated Ultraviolet Curing Lamp

- For Ultraviolet Cure Adhesives and Resins
- Vacuum Mounts to Glass

The UB80 Battery Operated Ultraviolet Lamp is a portable source of long wave U.V. light that attaches to the glass with a single vacuum cup. It transmits the maximum U.V. light while screening out visible white light. Excellent for use with UV cure windshield repair resins, which cure faster and more uniformly when exposed to concentrated ultraviolet light rays. The UB80 operates on four AA batteries (supplied). Replacement bulbs are available by ordering Cat. No. UV240BULB (see below).

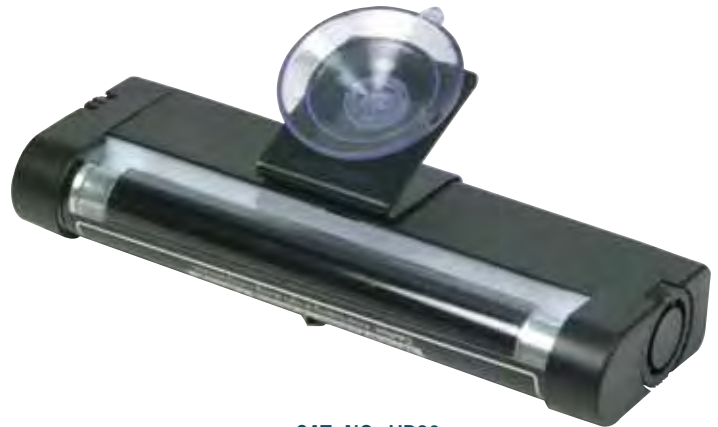

CAT. NO. UB80

CRL 12V Adaptor for UV Lamp

new



CAT. NO. CL12V

This Adaptor allows you to power the UB80 Ultraviolet Curing Lamp from the vehicle's cigarette lighter outlet. A terrific way to reduce the expense of battery replacement.

CRL Replacement Ultraviolet Bulb

- Fits Our UV240 and UB80 Ultraviolet Curing Lamps
- 4-Watt Integrally Filtered Tube

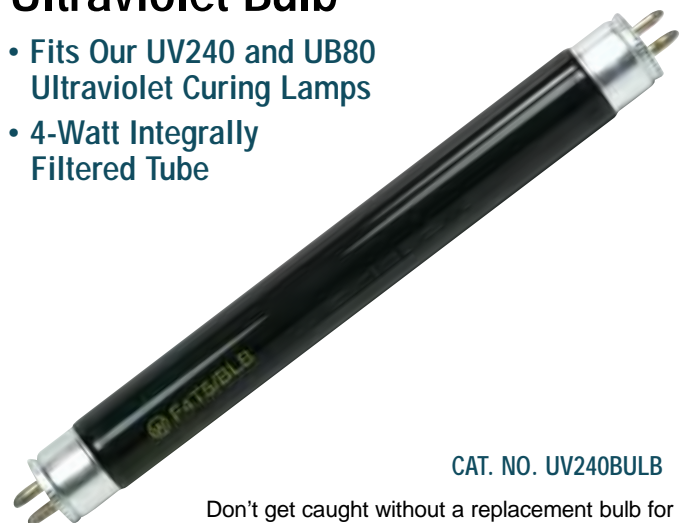

CAT. NO. UV240BULB

Don't get caught without a replacement bulb for your ultraviolet curing lamp. CRL's Replacement Bulbs are easy to replace, and will keep you up and running if your bulb happens to burn out.

CRL Cinch Windshield Repair System

new

- Exclusive Patented Design Injects Resin Without Losing Vacuum
- Quicker Average Repair Time
- Completely Portable
- Operates at Any Angle

The CRL Cinch Windshield Repair System offers the windshield repair market a newly developed way to perform windshield repairs. The CRL Cinch has several features not found with any other kit. It allows you to draw a vacuum on the repair free of a resin pool so that the air and moisture is evacuated without contaminating the resin. The outer chamber of the Cinch creates a vacuum over the repair, thus removing moisture and air from the void. The resin chamber inside the vacuum chamber is then lowered into position over the repair without losing the vacuum. The resin is then hydraulically pushed into the vacuum void and flows readily into the repair cavity. Retraction of the resin chamber creates an additional vacuum cycle and, with a final hydraulic pressure cycle, the repair is complete.

All types of repairs are completed much quicker than typical resin-on-glass repair systems, including bull's eye, daisy, star, and combination breaks. The medium viscosity resin is thick enough to remain in place even on vertical surfaces, such as bus, truck, and RV windows.

There are two versions of the Cinch System: the Basic Kit will perform about 100 repairs; the Deluxe Kit can make up to 300 repairs. Both contain the tools and supplies required to make successful repairs that will meet your customer's requirements and approval.



Resin Chamber can be repositioned for repairs close to moldings



Basic Kit
CAT. NO. CNK1B



Deluxe Kit
CAT. NO. CNK2D



The Cinch Resin Chamber holds the resin supply above the repair cavity, and is under constant vacuum during the repair process. This method produces superior repairs over resin-on-glass repair systems

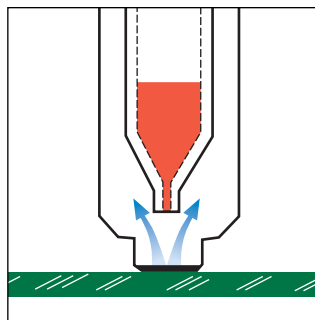

Resin Chamber under vacuum

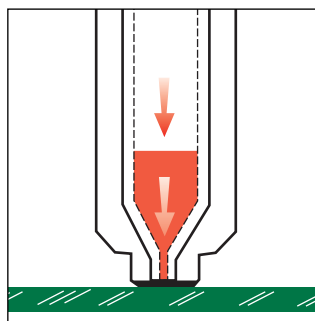

Hydraulic pressure forces resin into the cavity

- Cinch Device
- Bridge and Adjuster Screw
- Hand Vacuum Pump
- Carbide Scribe
- Mylar Squares (20)
- Resin (One 1 Oz. Bottle)
- Bottle for Solvent
- Razor Blades (5)
- Replacement Seals
- Extra Inserts (4)
- Instruction Video and Manual
- Molded Carrying Case

- Cinch Device
- Bridge and Adjuster Screw
- Hand Vacuum Pump
- Carbide Scribe
- Replacement Seal Kit
- Mylar Squares (200)
- Resin (Three 1 Oz. Bottles)
- Pit Polish (One 1/2 Oz. Bottle)
- Bottle for Solvent
- Razor Blades (5)
- Replacement Seals
- Extra Inserts (6)
- Suction Cup Lubricant
- Dremel™ Cordless Drill and Charger
- 1/16" Dremel™ Collet
- Carbide Tapered Auger Ball Burrs (10)
- UV Lamp
- Bull's Eye Maker
- Penlight
- Inspection Mirror
- Instruction Video and Manual
- Molded Carrying Case

For additional details and specifications on the CRL Cinch Windshield Repair System, contact Automotive Technical Sales by e-mail at techsales@crlaurence.com, or visit our web site at crlaurence.com.



LOG ON TO crlaurence.com FOR BUSINESS-TO-BUSINESS SERVICES

A222 | PHONE (800) 421-6144 | FAX (800) 262-3299 TOLL FREE FROM ANYWHERE IN THE U.S.A. OR CANADA

CRL Crystalene Windshield Repair Resins **new**

- High, Low, and Ultra-Low Viscosity Resins for a Complete Range of Auto Glass Repair
- Very Low Odor Formulas with Low VOC's
- No Cancer Causing Agents

These three new Crystalene Resins will perform a complete range of windshield repairs, from typical bull's eye, daisy, and star breaks, to more complex combination breaks and long cracks. The availability of three different formulas allows you the option of selecting just the right viscosity to make the best possible repairs.

Better yet, Crystalene Resins are formulated with low VOC's (Volatile Organic Compounds), and no cancer causing ingredients as listed by the state of California. This makes them safer and more pleasant to use because they are essentially odorless.

Crystalene Resins are not inhibited by oxygen in the atmosphere, nor will they shrink and pull away from the repaired surfaces. Mylar squares usually required with other resins are not needed when using Crystalene, thus reducing your costs and saving you time. All three Crystalene formulas feature an 18-month shelf life. You can perform 35 to 50 repairs from the one half ounce size bottle.



Crystalene Low Viscosity Break Repair Resin

- Best Formula for Most Typical Repairs

The repair of the most common windshield breaks (bull's eye, daisy, star, and combination types) calls for a resin that will flow evenly into the crevices of the cavity. This Crystalene Resin is formulated to handle the most common breaks you encounter, and leave results that will please your customers.



CAT. NO. CRLV12
1/2 Fl. Oz. (15 ml)

Crystalene High Viscosity Pit Fill Resin

- Formulated for the Final Repair Stage and Vertical Surface Repairs

This Crystalene Resin handles two jobs: It fills in the small pits that may remain after a typical break is repaired with Break Repair Resin, and its thicker consistency will hold it in place for repairs on vertical surfaces, such as bus, trailer, and RV glass.



CAT. NO. CRHV12
1/2 Fl. Oz. (15 ml)

Crystalene Ultra Low Viscosity Crack Repair Resin

- The Perfect Choice for Crack Repairs

Ultra Low Viscosity Crack Repair Resin is used for repairing cracks emanating from breaks because it flows more easily into cracks than low or medium viscosity resins. It's generally too thin for other types of breaks, but is the answer for fixing cracks.



CAT. NO. CRUL12
1/2 Fl. Oz. (15 ml)

new

CRL Windshield Repair Counter Top Display

- Large Poster Captures Attention
- Display Fits On Your Counter Top and Demonstrates Repair to Generate Sales

CRL's Windshield Repair Counter Top Display captures your customer's attention to the fact that you offer this service. Large 14" by 19" (355 mm by 482 mm) Poster provides the initial attention-getting information, and with the Glass Display your customer is educated on what to expect from the repair. This system pre-sells your service without you speaking a word. The 3-Fold brochures can be stamped with your company information just in case the customer needs to reschedule his or her appointment. CRL's Windshield Repair Counter Top Display is a perfect addition to any glass shop's counter space. Display includes one Cat. No. POPWP5 Poster, one "Before and After" Glass Specimen and Holder, and 25 Brochures.



CAT. NO. POPWDS
Display



CAT. NO. POPWP5
Poster

CRL Plate Glass Repair Kit

- Saves Cost of Expensive Plate Glass Replacement

Save the cost of expensive plate glass replacement with the CRL Glass Saver Plate Glass Repair Kit. This product will repair stone and pellet damaged plate glass quickly and inexpensively by allowing you to fill voids in damaged plate glass, a problem commonly seen in storefront windows.

The repair system fills the void with a special resin and forms a slight bead around the damaged area. The resin is cured with an ultraviolet lamp forming a permanent repair that is slightly visible. It will allow you to perform 10 repairs and comes complete with a battery-operated ultraviolet curing lamp and complete instructions. It's an easy to use product that will open up another source of profit for your business.

To order additional supplies specify Cat. No. RPG, which will allow you to perform 10 more repairs.



CAT. NO. RPG10 Plate Glass Repair Kit



CAT. NO. RPG Resupply Kit

CRL Glass Bandage

- Provides Highly Visible Warning of Broken Glass Hazards
- Transparent - Does Not Block Vision or Light
- Self Adhesive - Remains In Place

Broken glass panes represent a significant safety hazard in factories, retail stores, office buildings, schools, hotels, and homes. Now CRL Glass Bandage offers a "quick-fix" until the glass can be replaced. Installation takes just minutes. Prevents air leakage while covering sharp edges and also seals in broken glass shards. Glass Bandage's brilliant red danger warning helps prevent harm to the public, reduces accident insurance claims, and possible legal suits. Glass Bandage is transparent, so it does not block vision and light - another safety plus!



CAT. NO. 7100
Roll Size 18" by 120"
(45 cm by 305 cm)



CRL Dremel™ Mini-Mite Cordless Rotary Tool

- Small, Powerful, and Lightweight
- Excellent for Drilling Windshield Break Cavities for Resin

This small yet powerful CRL Dremel™ Mini-Mite Cordless Rotary Tool for the home and shop fits right into your hand, giving you the kind of maneuverability not usually found in a rotary tool.



CAT. NO. D750

It's excellent for windshield repairs where star breaks must be drilled for injection of resin. The D750 accepts Dremel™ and other bits with shanks up to 1/8" (3 mm) in diameter. Battery pack, charger, and five bits included.

CRL 1/16" Collet for Dremel™ Mini-Mite Cordless Rotary Tool

- Holds Carbide Burr Drills and Diamond Ball Burr Bits

This CRL 1/16" Collet for the Dremel™ Mini-Mite Rotary Tool accepts our Cat. No. DRL2020C Carbide Burr Drills and Cat. No. ADK3D Diamond Ball Burr Bits used with windshield repair methods.



CAT. NO. D482

CRL Tapered Auger Carbide Burr Drills

- Long Lasting Carbide Tip for Use in Dremel™ Tools

These CRL Tapered Auger Burr Drills for windshield repair quickly open the break area for quick resin flow. These burrs are virtually unbreakable as the tapered tip easily drills the glass and the tapered auger design brings the material to the surface keeping the drilling process cooler than when using a ball style burr. 10 Drills per package.

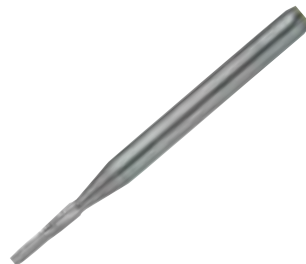

CAT. NO. DRL2021C

NOTE: Requires Cat. No. D482 1/16" Collet when using in a CRL Dremel™ Mini-Mite Cordless Rotary Tool or CRL Dremel™ Moto Tool.

CRL Dremel™ Moto Tool Kit

- 40 Piece Bit Assortment Included
- Variable Speed 5,000 to 30,000 RPM

The CRL Dremel™ Moto Tool Kit consists of a Model 395 variable-speed (5,000-30,000 rpm) Moto Tool with ball bearing motor construction to reduce friction for longer life; double insulated motor so grounding is not required; thrust bearing for greater drilling capacity; compact two wire coil cord for convenient storage in kit box.



CAT. NO. D3950

Excellent for windshield repairs where star breaks must be drilled for injection of resin. The tapered housing shape is comfortable for fingertip control. The keyless chuck allows fast replacement of bits with shanks up to 1/8" (3 mm). Adapter uses collets from 1/32" to 1/8" (.8 to 3 mm) for fine control.

CRL Felt Polishers for Dremel™ Tools

new

- Used to Improve the Clarity of Repairs

CRL Felt Polishing Tips will polish your repairs to the best possible clarity. Choose from three sizes. All use the Cat. No. M401 Mandrel, which must be ordered separately.



3/8" Diameter

CAT. NO. DR422



1/2" Diameter

CAT. NO. DR414



1" Diameter

CAT. NO. DR429



Mandrel

CAT. NO. M401

CRL Diamond Ball Burr Bit

- Fast Drilling to Open Repair Areas for Resin

This CRL Diamond Ball Burr Bit for windshield chip repair opens repair areas to create a pool for better resin flow. Increases potential for better results by gaining access to the start of the cracks in the center of the damaged area. Be sure never to drill deeper than the height of the ball burr to prevent damage to the inner layer of PVB.

1 Drill per package.

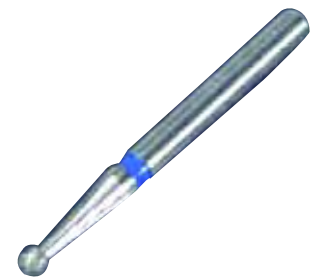

CAT. NO. ADK3D

NOTE: Requires Cat. No. D482 1/16" Collet when using in a CRL Dremel™ Mini-Mite Cordless Rotary Tool or CRL Dremel™ Moto Tool.

CRL Glass Surface Restoration Systems

- Add a New Service to Your Business
- Offer Your Customers an Alternative to Glass Replacement
- New Technologies Make Glass Surface Restoration Easy

Chemical Reaction Glass Damage

Strongly adherent surface deposits made by repeated exposure to standing water and chemicals produce stains that even the best glass cleaners can't remove. These stains are classified into two categories, Stage I Corrosion (glass with light corrosion and little or no damage to the glass), and Stage II Corrosion (deposits are no longer on the glass surface, but have started to break down the molecular structure of the glass).

Chemical Reaction Glass Damage Restoration

Light Stage I Corrosion can be removed with CRL Sparkle Cleaner and Stain Remover (Cat. No. SP101), and heavy Stage I Corrosion calls for professional strength Bio-Clean Water Stain Remover (Cat. No. WSR1) shown below. Both of these fine products are applied manually with a water rinse to produce excellent results. Depending on the circumstances, Stage II Corrosion may be removed with CRL powered scratch removal equipment shown on the following pages.



Chemical Reaction Glass Damage



Mechanical Glass Damage

Mechanical Glass Damage

The most common causes of mechanical glass damage include impact from hard or sharp objects, windshield wiper scratches, mishandling, poor cleaning, and graffiti scratches. Typically the depth of the damage is .020" or less. Extreme scratch damage or heavy acid etching caused by vandalism may not be repairable.

Mechanical Glass Damage Restoration

CRL offers a variety of powered scratch polishing systems for mechanical glass damage restoration shown on the following pages. Using a series of ultra-hard polishing materials, and depending on the severity of the damage, a great deal of the automotive and flat glass that normally would require replacement can now be repaired. For additional information, contact CRL Technical Sales at (800) 421-6144 in the U.S., or (877) 421-6144 from Canada, and ask for Ext. 7720.

CRL Bio-Clean Water Stain Remover

- Effectively Removes Water and Mineral Stains, Rust, Tree Sap, Paint Overspray, Soap Scum, and Mildew from Glass and Other Surfaces
- Removes Stage I Corrosion Quickly



CAT. NO. WSR1

Stage I Corrosion is defined as glass with light corrosion, and little or no damage to the glass. Stage II Corrosion occurs when the deposits are no longer on the surface of the glass, but have started to break down the molecular structure of the glass, leaving an etched or white haze on the glass after the stain has been removed. CRL Water Stain Remover will not repair glass with Stage II Corrosion.

This professional strength cleaner is recommended for use by glazing contractors and professional window cleaning companies. It is successfully used in hospitals, nursing homes, manufacturing plants, hotels, supermarkets, and other public facilities with difficult to clean surfaces. Apply CRL Bio-Clean to a surface with a dry cloth, sponge, brush or oscillating buffer. Press firmly to loosen stain with a rubbing action, then just rinse with water until residue free. Can be reapplied as needed until surface is clean. Packaged in 16 Fl. Oz. (473 ml) bottles.

CRL "Sparkle" Cleaner and Stain Remover

- Cleans Stains from Glass

CRL "Sparkle" Cleaner does those glass cleaning jobs too tough for spray-on cleaners. It removes light water spots and stains in glass caused by weather, sea air or pollution; also removes soap scum from shower doors and ceramic tile. Use it on auto glass to remove water spots from automatic windshield washers. Wipe on with a damp cloth or paper towel, rub stained areas, then wipe off. Packaged in 8 Fl. Oz. (237 ml) bottles.



CAT. NO. SP101

A complete selection of Glass Cleaners and Wipes can be found on pages A148 to A159.



CRL Scratch-A-Way® Scratch Removal System

- Clean Working System for Light Scratches
- Flexible Rubber Shroud Keeps Slurry Contained

Auto Glass Applications

- Wholesalers - Remove Light Scratches Quickly
- Technicians - Remove Light Scratches, Wiper Blade Marks, Stains and Acid Spots, Etc.

Flat Glass Applications

- Remove Light Scratches Quickly
- Polish Fabricated Beveled Mirror Corners and Areas Needing Blending
- Insulating Glass - Fix In-Shop or On-Site Scratches



Two Types of Scratches...

Light Surface or Scuff Mark Scratch

Over 95% of all scratches are light scratches or scuff marks. The magnified image, at right, is what a light scratch looks like. This scratch can be removed.

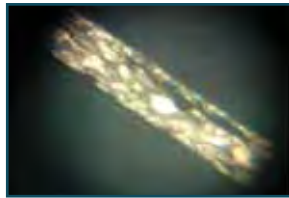

Heavy/Deep Scratch

The magnified image, at right, is a heavy/deep scratch that cannot be removed with this system.



For Light Scratch and Scuff Mark Removal

After cleaning the glass thoroughly, inspect the area with the Diagnostic Inspection Tool. Mark the scratch area from the underside with the red marking pen. Attach the polishing disc to the polishing head. Then apply water to the surface of the scratch, and work the polishing head, very slowly, with consistent pressure, back and forth in the direction of the scratch. Work the area for 30 seconds, and then stop. Wipe the slurry away from the scratch with the edge of the red shroud, so you can inspect the progress of your work. Repeat until scratch is removed.



CRL Scratch-A-Way® Electric Powered Scratch Removal Tool Kit for Light Scratches

- Achieves the Perfection of Original Glass
- Repairs Done in Just a Few Minutes
- Reduce the Cost of Reassembling Glass Panels
- Delays are Minimized
- Clean Procedure - Only Water is Needed



CAT. NO. S965020

KIT CONTAINS: 115V AC Electric Tool, Diagnostic Inspection Tool, Five Polishing Discs, Marking Pen, Chamois, Instructional CD with Manual, and Plastic Storage Case.

CRL Scratch-A-Way® Diagnostic Inspection Tool

- Inspect Depth and Width of Scratches
- Inspect Bevels and Edgework in Post Fabrication Process



The Diagnostic Inspection Tool magnifies the surface image 30 times. The left section of the tool is illuminated so the scratch can be viewed clearly. The rotary wheel adjusts the focus of the viewing area.

CAT. NO. S93085

CRL Scratch-A-Way® Cerium Oxide Discs and Back Up Plates



Discs



Back Up Plates

Cerium Oxide Polishing Discs are 2" (51 mm) in diameter, and have an estimated work life of approximately 20 scratches that are 2" (51 mm) long.

CAT. NO.	DESCRIPTION	QTY/PKG
S93054	Cerium Oxide Polishing Disc	10
S93075	Back Up Plate with Velcro	1

CRL Windshield Scratch Polishing Kit

- Remove Light Surface Scratches
- Polish Out Rubs, Fine Lines, Stains, and Discoloration on Mirrors or Glass of Any Kind
- Lightweight, So You Can Work on Windshields Right in the Car
- Well Balanced for Smooth Action
- Heavy-Duty for Long Life

Perfect balance and properly placed handles make it possible to work with the windshield right in the car, thus lowering the labor time and the cost of replacing an expensive curved windshield.



The CRL Windshield Scratch Polishing Kit is designed to meet the demand for a low-priced, lightweight, portable tool capable of removing light surface scratches from automobile windshields. It also can be used to polish out rubs, fine lines, stains, and discolorations on mirrors or glass of any kind. Also, this tool can be used as a sander by using a backup pad and sanding discs. Operates on 110V AC.

The CRL Scratch Polisher will remove light scratches and water deposits from glass. Generally, if you run your fingernail over the scratch and it catches, the scratch is too deep to be removed with the polisher. However, light scratches, windshield wiper rubs, and some water deposits can be removed by following these instructions.

Limits of Polishing

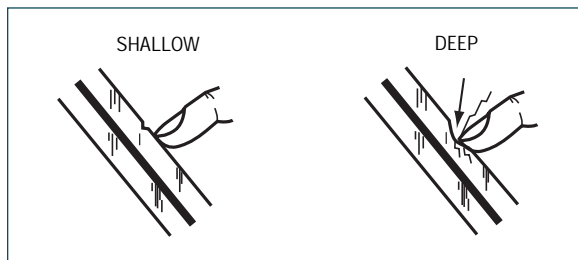

Light, shallow scratches and rubs can be removed satisfactorily.

Deep scratches and rubs can only be lessened, not completely removed.



CAT. NO. CRL9257

Included in the CRL9257 Kit:

- Cat. No. PV7001C Makita 7" Vertical Polisher with Variable Speed (600 - 2,000 rpm)
- Rubber Back-Up Pad
- Spanner Wrench
- Side Handle
- Cat. No. 5702 Polishing Head (3" Diameter x 1-1/2" All Wool Felt Pad)
- Cat. No. C0301 Cerium Oxide (One Pound)

CRL Heavy-Duty Scratch Polisher

- Polishes All Types of Glass, from Windshields to Watch Crystals
- Use it Hand Held or Bench Mounted for Added Stability

Use the CRL Heavy-Duty Scratch Polisher as either a bench mounted or hand held polisher with excellent results. It is fitted with a high quality wool felt wheel that will polish virtually all types of glass, from windshields, sheet glass, edges, and bevels to watch crystals. Heavy-duty, double-insulated 110V AC motor. Sure grip handles on each end of the tool assembly provide control.

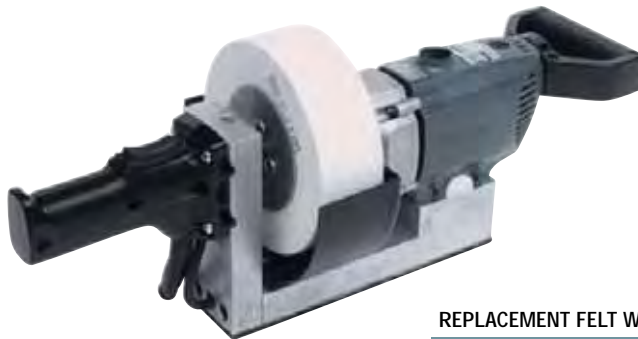

CAT. NO. YP85



CAT. NO. YPF6



CAT. NO. YPF6X2N

REPLACEMENT FELT WHEELS

CAT. NO.	YEARS	SIZE	ARBOR
YPF6	Through 1989	6" x 1-1/2"	2-3/4"
YPF6X2N	1990 to Present	6" x 2"	2"



LOG ON TO crlaurence.com FOR BUSINESS-TO-BUSINESS SERVICES

A228 | PHONE (800) 421-6144 | FAX (800) 262-3299 TOLL FREE FROM ANYWHERE IN THE U.S.A. OR CANADA

CRL Complete Polishing Head Assembly

- Used for Light Scratch Removal
- Can Be Used with a Cordless Drill



This 1-1/2" (38.1 mm) thick by 3" (76.2 mm) diameter wool felt wheel, aluminum adapter plate, and 1/4" diameter shank all combine to make the CRL Polishing Head Assembly. Use it with our Cat. No. PV7001C Polisher, or chuck it into your electric drill.



CAT. NO. 5703

CRL All Wool Felt Wheel

- For Use with the 5701 Adapter

Made from the highest quality Spanish Felt, this 3" (76.2 mm) diameter, 1-1/2" (38.1 mm) thick buffing wheel can remove scratches, stains, and discoloration from glass and mirrors. Used with the 5701 Aluminum Adapter, this economical wheel can work wonders in the smallest of spaces. Also replaces the wheel on the 5703 Polishing Head Assembly.



CAT. NO. WFD03112

CRL Aluminum Adapter

- Used with the WFD03112 Felt Wheel



CAT. NO. 5701

The CRL Aluminum Adapter is machined and tested true to run smoothly while on the CRL9257 or when used with the 5704 Adapter. The WFD03112 All Wool Felt Wheel is adhered to the bottom surface of this Adapter by using 3M8001 Super Weatherstrip Adhesive or LN601 Construction Adhesive.

CRL Aluminum Adapter and Felt Wheel

- Used with the CRL9257 Scratch Polisher



CAT. NO. 5702

The CRL Aluminum Adapter and Felt Wheel consists of one 5701 Aluminum Adapter and one WFD03112 All Wool Felt Wheel cemented together. Keep a spare on hand if you do a lot of scratch removal with your CRL9257.

CRL Shank Adapter

- Use Any 5/8-11 Mount Disc with a Hand Drill



CAT. NO. 5704

The CRL Shank Adapter is designed for use in any hand drill. The 5/8-11 threads insert into popular disc pads such as the CRL 5702.

CRL Cerium Oxide

- Used with the CRL9257 Scratch Polisher



CRL Cerium Oxide is a high grade optical polishing compound used to lessen and polish scratches from mirror bevels, table top edges, glass in vehicles or structures. CRL Cerium Oxide is mixed with water to form a paste or slurry. This compound has excellent suspension qualities and will not harden. Contains no zinc oxide, and meets most local disposal ordinances.

CAT. NO.	CONTAINER SIZE
C0301	1 Pound (454 g)
C0305	5 Pounds (2.27 kg)
C0310	10 Pounds (4.54 kg)

Available in larger bulk packaging. Visit our web site at crlaurence.com for complete information.

CRL 3M™ Super Weatherstrip Adhesive

- Exceptional Bonding Strength
- Waterproof and Flexible



CAT. NO. 3M8001

CRL 3M™ Super Weatherstrip Adhesive is used for bonding and sealing weatherstripping to car trunks and doors. It also bonds WFD03112 Felt Wheels to 5701 Adapters with great adhesion. Easy to spread, extremely fast drying. Resists oil, grease, and solvents. Also a good general purpose cement. Contents: 5 Fl. Oz. (147 ml).

CRL 3M™ Trizact™ Scratch Removal Starter Kits

- The Best Way to Start Using Trizact™ Discs
- Uses Your Hand Held Electric Drill
- Includes Five 3" Disc Pads for Quick Change-Out of Discs

Conventional coated abrasives tend to dull quickly in a glass repair operation. 3M's unique Trizact™ film provides long lasting, consistent cut and finish while minimizing the abrasive disc change-over and slurry clean-up. Trizact™ film consists of precisely shaped pyramids of fine grade mineral. As the top of these pyramids wear away fresh cutting mineral is continually exposed.

CRL 3M™ Trizact™ Scratch Removal Starter Kits are the most efficient way to start using CRL 3M™ Trizact™ products. Using your own hand-held cordless or 110V AC Electric Drill with a Ground Fault Circuit Interrupter (Cat. No. GF1), you can remove scratches ranging from very fine to very deep. This amazing new material uses natural abrasives formed in the shape of small pyramids, and provides uniform layers of abrasive throughout the pyramid. As the abrasive particles are used, they get flushed away exposing new abrasive. So easy to use, almost anyone can start to remove scratches with this kit within a short time.

Trizact™ Starter Kits Include:

- 20 Assorted 3" (76 mm) 3M™ Trizact™ Abrasive Discs
- Four 3" (76 mm) 3M™ Medium Disc Pads
- 8 Ounce Glass Polishing Compound
- Spray Bottle for Water
- 1/4" (6.4 mm) Shank Adapter
- Plastic Apron
- Full Instructions



Drill shown but not included.

CAT. NO.	DESCRIPTION
ZSRPSSKS	3M™ Trizact™ Starter Kit for Curved Glass
ZSRPSSKM	3M™ Trizact™ Starter Kit for Flat Glass

CRL 3M™ Trizact™ Professional Scratch Removal System

- Developed for Professionals
- Powerful Center Water Feed Polisher
- Works on Light to Heavy Scratches Including Wiper Marks

The CRL 3M™ Trizact™ Professional Scratch Removal System is a breakthrough in scratch removal and glass or polycarbonate polishing. Now this once complicated and messy process is simple and clean without any slurries or compounds to mix. Our all-new more powerful polisher has more power and torque than ever! With its on-demand water delivery system, the constant water flow adjustments are a thing of the past. This system uses plain water, which is delivered through the center of the pad so very little is required. The natural abrasives used in these discs are formed in the shape of small pyramids. The pyramids are then layered so as the disc wears, a new abrasive surface is exposed. Four grades of abrasive discs are included to remove the deepest of scratches. A cerium oxide pad is used to polish the glass during the final step. The results this system offers is nothing short of amazing. It could pay for itself in its first use when the cost of labor and materials of replacing a windshield are factored in.

PLEASE NOTE: Scratch polishing is an abrasive process which when certain factors are present, can affect your final polished product, such as one or more of the following examples: **Scratch Depth** - the deeper the scratch, the more difficult it will be to produce a clean and distortion-free surface; **Glass Temperature, Technique** - following instructions and keeping work surface clean between steps is crucial; **Glass Curvature** - windshield, architectural, etc; **Glass Type** - float, tempered, textured, coated reflective, mirrored or tinted.

Trizact™ Professional Kits Include:

- 10 Each of the Five Different Grades of 5" (127 mm) 3M™ Trizact™ Abrasive Discs
- Five Each 5" (127 mm) 3M™ Soft Disc Pads (Curved Glass) or Medium Disc Pads



CAT. NO.	DESCRIPTION
ZSRPSS	3M™ Trizact™ Professional System for Curved Glass
ZSRPSSM	3M™ Trizact™ Professional System for Flat Glass

For additional information, visit our web site at crlaurence.com, or e-mail techsales@crlaurence.com.

- 115 Volt Center Water Feed Polisher with GFI Built-In
- Pressurized Water Delivery System
- 1 Pound of Cerium Oxide
- Full Instructions and 3M Application Guide



LOG ON TO crlaurence.com FOR BUSINESS-TO-BUSINESS SERVICES

A230 | PHONE (800) 421-6144 | FAX (800) 262-3299 TOLL FREE FROM ANYWHERE IN THE U.S.A. OR CANADA

CRL GLASS SURFACE RESTORATION

For Pricing on CRL Products, Call Toll Free (800) 421-6144, or Visit crlaurence.com

CRL 3M™ Trizact™ Discs

- 3M™ Trizact™ Films - A Cleaner, Long Lasting Abrasive System for Glass Scratch Repair

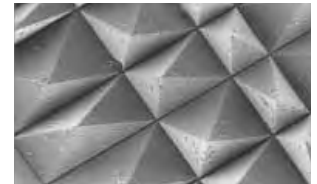

The precisely structured surface of Trizact™ film is clearly visible under 50X magnification

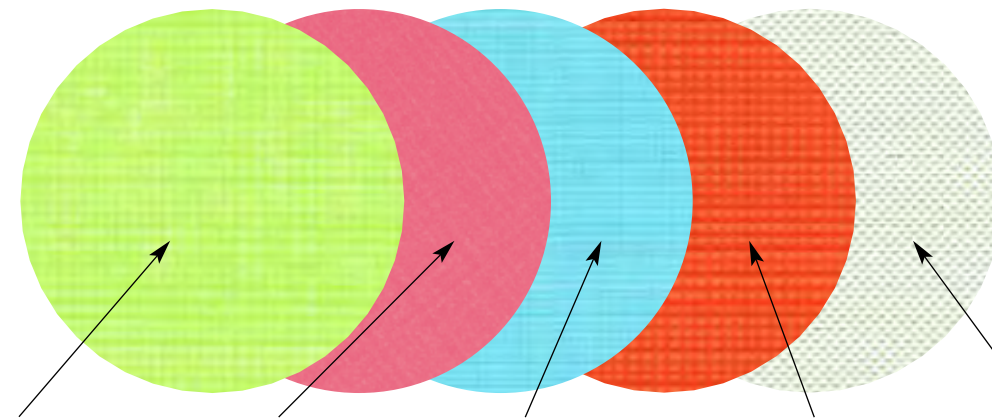

CAT. NO.	GRADE	DESCRIPTION
TD335P	A35	3" Disc
TD320P	A20	3" Disc
TD310P	A10	3" Disc
TD35P	A5	3" Disc
TD3CP	Cerium	3" Disc
TD535P	A35	5" Disc
TD520P	A20	5" Disc
TD510P	A10	5" Disc
TD55P	A5	5" Disc
TD5CP	Cerium	5" Disc

All Trizact™ Discs can be combined for quality pricing.

TD335P and TD535P	TD320P and TD520P	TD310P and TD510P	TD35P and TD55P	TD3CP and TD5CP
Removes Larger Scratches and Defects	Removes Moderate Scratches and Defects	Refines Scratches, Removes Scuffs and Acid Marks	Refines Scratches, Removes Defective AR Coatings	Polishes and Leaves Glass Crystal Clear
Use the A35 Discs as the first step in removing larger scratches and defects. A small amount of water triggers the cutting action. Controlled water flow helps reduce heat and keep the glass cooler.	Use the A20 Discs when the scratches are significant but not as deep as those requiring the A35 Discs. Very aggressive like the A35, the A20 requires adequate water flow to reduce heat and keep the glass cooler.	Use the A10 Discs to refine the scratches left by the A35's, or start with A10 Discs to remove shallow scratches, scuffs, and acid marks. Apply a small amount of water to start the grinding action. Control the water flow to avoid generating too much heat.	Use the A5 Discs to further refine any scratches left by the A10's. As in previous steps, apply a small amount of water to start cutting action. Avoid extended dwell time to minimize heat build-up.	Use this Cerium Oxide Disc for a final polish. To begin, wet the surface slightly with a small amount of water. As you polish, the pyramids will break down to form a slurry-like solution. The polishing action that occurs will remove scratches left by previous leveling steps.
Also available in other sizes. Visit our web site at crlaurence.com .				

CRL 3M™ Trizact™ Disc Pads

- Medium for Flat Glass, Soft for Curved Glass



To get the most use out of your Trizact™ Discs and to achieve the best results, use a separate Disc Pad for each grade of disc.

CAT. NO.	DESCRIPTION
02599	5" Medium Density Disc Pad
02814	Adapter for 02599 Pad
ZDP3P58M	3" Medium Density Disc Pad
ZDP3P58S	3" Soft Disc Pad

CRL Drill Adapter

- Adapts Trizact™ Disc Pads to Your Drill



CAT. NO. DPAS58

This high quality CRL Drill Adapter allows any of our 3M™ Trizact™ Disc Pads to be used with any power drill with a standard 3/8" (9.5 mm) or larger chuck. Made from heavy-duty stainless steel.

CRL Ground Fault Circuit Interrupter

- A Must for Anyone Using Wet-Working Tools



CAT. NO. GF1

With the CRL GF1 Ground Fault Circuit Interrupter, you are always protected against possible shock or electrocution. For more information, see page A301.

CRL Cerium Oxide

- Used for High Grade Polishing



CAT. NO. C0301

A high grade optical polishing compound. Used as the final step with 3M™ Trizact™ Cerium Polishing Discs to produce a "water clear" finish. Contains no zinc oxide, and meets most local disposal ordinances. Contents: 1 pound (454 g).

Trizact™ and 3M™ are Registered Trademarks of the 3M Co., Inc.

LOG ON TO crlaurence.com FOR BUSINESS-TO-BUSINESS SERVICES

PHONE (800) 421-6144 | FAX (800) 262-3299 TOLL FREE FROM ANYWHERE IN THE U.S.A. OR CANADA | A231



CRL SRP™ Professional Scratch Removal and Polishing Systems

- Perfect for Windshield Repair
- Cost Effective - Saves Money in Manufacturing, Distribution or Fabrication Environments by Reducing Scrapped Glass
- Cost Effective in the Field by Saving the Cost of Removal, Replacement, and Reinstallation
- Efficient - Quickly Removes Scratches That Until Now Were Considered Unrepairable
- Portable - Completely Self-Contained, Requiring Only a 110V AC Power Source
- Clean - Closed Loop System Eliminates Splattering and Mess Associated with Other Scratch Removal Methods



Repairs Can Be Made Without Removing Glass

The CRL SRP™ Scratch Removal and Polishing Systems offer a revolutionary process that removes scratches quickly and cleanly from virtually any type of glass, from tempered to single strength, right in your shop or on the job site. The hand held tools use a vacuum process in conjunction with a continuous flow of slurry through the

machine. With adjustable water jets providing lubrication to keep the machine moving freely over the glass, the flow of slurry provides a constant source of new abrasives. This process keeps the glass cool and allows the tool to reach polishing speeds of 6,000 rpm. A reference manual and training video are included with each kit.



CRL SRP™ Scratch Removal System

The complete CRL SRP™ Scratch Removal System includes a Finer (Smoothing) Unit, which performs the grinding or heavy stock removal, and the Polishing Unit, which performs the polishing or light stock removal. Each unit comes with its own slurry container and pump to prevent contamination, and for ease of use. The complete system gives you the capability to remove any type of scratch, including those made with a glass cutter!

Everything needed to get you up and running is included in the kit, as well as an ample supply of consumable items. A maintenance kit, reference manual and training video complete the package. For details on kit contents, go to crlaurence.com.

CAT. NO. PN8930

Complete Scratch Removal System

CRL SRP™ Polishing System

The CRL SRP™ Polishing System is used on scratches and scuff marks that do not require grinding. It can even remove scratches you can feel with your fingernail.

Recommended primarily for manufacturing and distribution facilities, the Polishing System is also widely used in the field by windshield repair technicians for removing wiper blade scratches.

The Polishing System includes a Polisher Unit, a slurry container and pump, power cord, maintenance kit, reference manual, training video, and all of the necessary supplies needed for immediate use. For details on kit contents, go to crlaurence.com.

CAT. NO. PN8932

Complete Polishing System



LOG ON TO crlaurence.com FOR BUSINESS-TO-BUSINESS SERVICES

A232 | PHONE (800) 421-6144 | FAX (800) 262-3299 TOLL FREE FROM ANYWHERE IN THE U.S.A. OR CANADA

CRL SRP™ Fining Compound

• For Deep Scratches

CRL SRP™ Fining Compound is the same powder supplied with the CRL SRP™ Scratch Removal System. It is used with the fining part of this system for removing deep scratches, graffiti, and scuff marks that require heavy grinding before the polishing stage. After using the Finer System and compound, the glass appears to be frosted. Then the polisher is used to "smooth" out the glass surface. Each bag contains 14 ounces, enough material to fill one slurry container.



CAT. NO. PN8915

CRL SRP™ Fining Discs

These CRL SRP™ Replacement Fining Discs are made from an aluminum alloy which is softer than glass. The disc itself does not perform the actual cutting, it merely traps the Fining Compound's abrasive particles in the disc's small holes. This in turn does the cutting action. As these economical discs wear, they become less efficient in trapping the abrasive compound, so they must be replaced. The adhesive backed discs press easily onto the fining machine's pad base. One pack consists of fifty 1-3/8" discs.

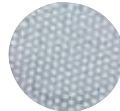

CAT. NO. PN8230

CRL SRP™ 3" Flat Polishing Wheel

This CRL SRP™ Replacement Flat Polishing Wheel is the same felt wheel supplied in CRL SRP™ PN8930 and PN8932 Systems. Originally designed to remove hard water stains, it can also be used for removing scratches and scuff marks on flat surfaces that do not require heavy grinding. Also for use on moderate scratches you can feel with your fingernail. Easily installs by reverse threading onto the end of the CRL SRP™ Polishing Machine.



CAT. NO. PN8912

CRL SRP™ Finer Shroud Seals

These CRL SRP™ Replacement Shroud Seals are the same seals that are supplied in the CRL SRP™ Scratch Removal Systems. Used mainly on the Finer Machine, these blended foam "doughnuts" create a vacuum seal between the Fining unit and the glass. The seals have a lower coefficient of friction which allows the unit to slide freely and easily on the glass. Seals can also be used with the SRP™ Polisher when polishing out fining marks. From time to time, seals get cut and/or wear from excessive use and need replacing. One pack consists of six seals.



CAT. NO. PN9036

CRL SRP™ Polishing Compound

• For Light Scratches

CRL SRP™ Polishing Compound is supplied in CRL SRP™ PN8930 and PN8932 Systems for removing scratches and scuff marks that do not require heavy grinding. It is often referred to as "cerium oxide" but in reality, it is a mixture of abrasives, which would be considered a high purity cerium mix. Each bag is enough to fill one slurry container. Sold only in fourteen ounce bags.



CAT. NO. PN9040

CRL SRP™ 3" Domed Polishing Wheel

CRL SRP™ Domed Polishing Wheel is the same felt wheel supplied in CRL SRP™ Scratch Removal Systems. It is used with each of these systems for removing scratches and scuff marks that do not require heavy grinding. The domed pad is designed to polish in a small or concentrated area. It can even be used to remove scratches you can feel with your fingernail. Easily installs by reverse threading onto the end of your CRL SRP™ Scratch Polisher.



CAT. NO. PN8911

CRL SRP™ 3" Solid Flat Polishing Wheel

The CRL SRP™ Replacement Solid Flat Polishing Wheel is the same felt wheel supplied in the CRL SRP™ PN8930 and PN8932 Systems. This pad was designed to remove scratches with less distortion due to it covering more surface area than standard pads. It can also be used to remove hard water stains and scuff marks on flat surfaces that do not require heavy grinding. Easily installs by reverse threading onto the end of the CRL SRP™ Polishing Machine.



CAT. NO. PN9030

CRL SRP™ Polisher Shroud Seals

CRL SRP™ Replacement Shroud Seals are the same as the ones supplied in CRL SRP™ Scratch Removal Systems. Used only on the PN8932 Polisher, these neoprene rubber "doughnuts" create a vacuum seal between the Polishing unit and the glass. They also allow the unit to slide freely and easily on the glass. From time to time, these seals get cut and/or wear from excessive use and need replacing. One pack consists of six seals.



CAT. NO. PN8278

CRL Mirror Bracket Kits

- Includes Our Most Popular Brackets, Adhesive, and Removal Tools

Our Rear View Mirror Bracket Kits contain the brackets, adhesive, and tools you need for a professional quality installation of Rear View Mirror Brackets. These two kits contain the most popular Mirror Bracket styles, as well as four Rear View Mirror Removal Tools. Add to this CRL Loctite™ Minute Bond Adhesive, Razor Blades with a Holder, and a Plastic Compartment Box to hold it all. It's an easy way to stay organized and have the items you need for most mirror bracket installations.

CRL Standard Mirror Bracket Kit

- Four of the Most Popular Brackets, Plus Removal Tools and Adhesive



CAT. NO. MBK1T

Standard Mirror Bracket Kit Contains: One of each Small Parts Box; MB2, MB2TX, MB3, and MB4 Mirror Bracket Tools; 3223 Razor Blade Scraper; 3346 Loctite Adhesive; One Ten Pack of each MB2525, MB3088, MB3289A, and MB3543 Mirror Brackets; 25 each 51S Single Edge Razor Blades.

CRL Deluxe Mirror Bracket Kit

- 13 of the Most Popular Brackets, Plus Removal Tools and Adhesive

new



CAT. NO. MBDK1T

Deluxe Mirror Bracket Kit Contains: One of each Small Parts Box; MB2, MB2TX, MB3, and MB4 Mirror Bracket Tools, 3346 Loctite Adhesive; 3223 Razor Blade Scraper; 25 each 51S Single Edge Razor Blades; Two each AGC1Z, AGC2Z, AGC3Z, AGC6, AGC7, AGC11, AGC12, AGC13Z, AGC14Z, AGC15Z, AGC19, AGC25, and AGC26 Mirror Brackets.

CRL Mirror Brackets • Our Most Popular Brackets in Single or Multiple Packs

Ford/GM/Chrysler

Zinc

CAT. NO.	QTY/PKG
AGC2Z	1
MB3088	10
S3088	*Bulk 100



Ford Deep "V"

Zinc

CAT. NO.	QTY/PKG
AGC13Z	1
MB3543	10
S3543	*Bulk 100



Chrysler

Zinc

CAT. NO.	QTY/PKG
AGC1Z	1
MB2525	10
S2525	*Bulk 100

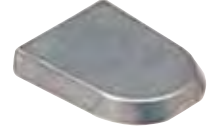

Ford/GM

Zinc

CAT. NO.	QTY/PKG
AGC3Z	1
MB3289A	10
S3289A	*Bulk 100



Ford Breakaway

Zinc

CAT. NO.	QTY/PKG
AGC14Z	1
MB314Z	10



Jeep Cherokee

Zinc

CAT. NO.	QTY/PKG
AGC11	1
MB311	10



Honda (U.S.)

Zinc

CAT. NO.	QTY/PKG
AGC7	1
MB307	10

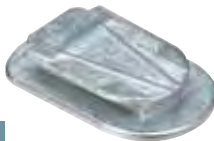

Honda

Zinc

CAT. NO.	QTY/PKG
AGC15Z	1
MB315Z	10



Hyundai

Zinc (Painted)

CAT. NO.	QTY/PKG
AGC12	1
MB312	10



* Minimum order for Bulk 100 pack is 100 each. All others are ordered by the pack.



LOG ON TO crlaurence.com FOR BUSINESS-TO-BUSINESS SERVICES

A234 | PHONE (800) 421-6144 | FAX (800) 262-3299 TOLL FREE FROM ANYWHERE IN THE U.S.A. OR CANADA













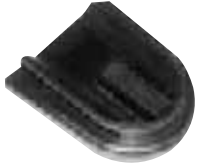





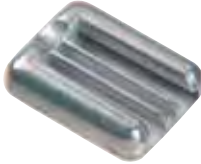

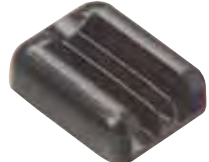

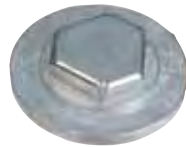
CRL MIRROR BRACKET REPAIR SYSTEMS

For Pricing on CRL Products, Call Toll Free
(800) 421-6144, or Visit crlaurence.com

CRL Mirror Brackets

- Single Packs of Commonly Requested Brackets

Our Replacement Mirror Brackets are available to complete one installation, or to replenish the Mirror Bracket Kits shown on the opposite page. All are OEM quality for fit and finish. See the next two pages for Bracket Installation and Removal Tools, and our selection of Bracket Adhesives and Primers.

<p>Ford Zinc</p>  <p>CAT. NO. AGC4Z One per Pack</p>	<p>GM Zinc</p>  <p>CAT. NO. AGC34 One per Pack</p>	<p>Chrysler/GM Plastic Adapter</p>  <p>CAT. NO. AGC25 One per Pack</p>
<p>Chrysler PT Cruiser Zinc</p>  <p>CAT. NO. AGC30 One per Pack</p>	<p>Cadillac Catera Zinc (Painted)</p>  <p>CAT. NO. AGC27 One per Pack</p>	<p>Audi A6/100 Zinc (Painted)</p>  <p>CAT. NO. AGC23 One per Pack</p>
<p>Honda Odyssey Zinc</p>  <p>CAT. NO. AGC21 One per Pack</p>	<p>Honda S-2000 Zinc</p>  <p>CAT. NO. AGC24 One per Pack</p>	<p>Honda Zinc (Painted)</p>  <p>CAT. NO. AGC8 One per Pack</p>
<p>Volvo Zinc</p>  <p>CAT. NO. AGC33 One per Pack</p>	<p>Hyundai Zinc</p>  <p>CAT. NO. AGC16 One per Pack</p>	<p>Hyundai Accent Zinc (Painted)</p>  <p>CAT. NO. AGC28 One per Pack</p>
<p>Jaguar/Rover Zinc</p>  <p>CAT. NO. AGC9 One per Pack</p>	<p>Jaguar XJ Zinc</p>  <p>CAT. NO. AGC19 One per Pack</p>	<p>Lexus Zinc</p>  <p>CAT. NO. AGC18 One per Pack</p>
<p>Lexus Zinc (Painted)</p>  <p>CAT. NO. AGC20 One per Pack</p>	<p>Lexus GS300/400 Zinc</p>  <p>CAT. NO. AGC26 One per Pack</p>	<p>Lexus Zinc</p>  <p>CAT. NO. AGC29 One per Pack</p>
<p>Mazda 929 Zinc</p>  <p>CAT. NO. AGC6 One per Pack</p>	<p>Mitsubishi Zinc (Painted)</p>  <p>CAT. NO. AGC22 One per Pack</p>	<p>Toyota 4-Runner Zinc</p>  <p>CAT. NO. AGC35 One per Pack</p>
<p>VW, BMW Zinc (Painted)</p>  <p>CAT. NO. AGC36 One per Pack</p>	<p>VW Passat Zinc</p>  <p>CAT. NO. AGC5 One per Pack</p>	<p>VW Passat Zinc (Painted)</p>  <p>CAT. NO. AGC17 One per Pack</p>

NOTE: Make and model listed for individual brackets is used as a starting point for identification. We suggest you use the photographs for best match as many brackets fit other makes and models. For additional assistance in locating the proper Mirror Brackets, contact CRL Automotive Technical Sales by e-mail at techsales@crlaurence.com.

LOG ON TO crlaurence.com FOR BUSINESS-TO-BUSINESS SERVICES

PHONE (800) 421-6144 | FAX (800) 262-3299 TOLL FREE FROM ANYWHERE IN THE U.S.A. OR CANADA | A235





CRL Loctite® Minute Bond Adhesive and Primer

- Clear Color Makes it an Excellent Rear View Mirror Bracket Adhesive
- Specified by Major Domestic and Import Auto Manufacturers
- Joins Glass to Metal Permanently in Just Seconds
- Four Kit Sizes Including Handy Single Application Size

CRL Loctite® Minute Bond Adhesive permanently bonds non-porous materials such as glass, metal, tile, coated wood, plastics, and nylon with superior strength holding power up to 3,000 psi. The combined primer and adhesive two-step application offers handling strength in 10 seconds, 60% full strength in two minutes, and a full cure in 24 hours. All Kits contain both Adhesive and Primer.



CAT. NO. 0144
1.69 Fl. Oz. Kit



CAT. NO. 3325
0.8 Fl. Oz. Kit



CAT. NO. 3346
0.2 Fl. Oz. Kit



CAT. NO. 30814
0.02 Fl. Oz. Kit



CAT. NO. 73656
Primer Improves Bond Strength

CAT. NO.	CONTENTS	QTY/BOX	MIN. ORDER
0144	1.69 Fl. Oz. (50 ml) Adhesive / 6 Oz. (170 g) Primer	5 Kits	1 Kit
3325	0.8 Fl. Oz. (24 ml) Adhesive / 6 Oz. (170 g) Primer	5 Kits	1 Kit
3346	0.2 Fl. Oz. (6 ml) Adhesive / 1.33 Oz. (38 g) Primer	12 Kits	1 Kit
30814	0.02 Fl. Oz. (0.59 ml) Adhesive / 0.02 Oz. (0.59 ml) Primer	12 Kits	1 Box
73656	6 Oz. (170 g) Minute Bond Primer	10 Cans	1 Can

NOTE: Minute Bond Adhesive is only recommended for use on non-porous flat surfaces that are to be mated together with a gap of .004-inch maximum. Where bond gaps are large, up to a maximum of .02 inch, or faster cure speed is required, Primer should be applied to both surfaces. Primer should be 72° F (22° C) or warmer. For more information, consult the package, or contact CRL Technical Sales at techsales@crlaurence.com.

CRL Replacement Interior Rear View Mirrors

- Three of the Most Popular Sizes **new**
- Built-In Day/Night Feature
- Comes with Mounting Bracket



CRL Replacement Interior Rear View Mirrors are ready to mount on GM or Ford Vehicles using the original mirror bracket. If the windshield does not have a bracket or if the existing bracket does not fit, simply use the mirror mounting bracket provided. Mirrors are FMV safety approved.

CAT. NO.	MIRROR DESCRIPTION
RVM8	8" Wide Replacement Mirror
RVM10	10" Wide Replacement Mirror
RVM12	12" Wide Replacement Mirror



LOG ON TO crlaurence.com FOR BUSINESS-TO-BUSINESS SERVICES

A236 | PHONE (800) 421-6144 | FAX (800) 262-3299 TOLL FREE FROM ANYWHERE IN THE U.S.A. OR CANADA

CRL Hex End Mirror Wrench

- 5/64" and 3/32" Ends



The CRL Hex End Mirror Bracket Wrench is perfect for quick removal or reinstallation of mirrors held in place with hex screws. Pocket clip keeps it handy.

CAT. NO. MB2

CRL Torx® End Mirror Wrench

- TX15 and TX20 Ends



Our CRL Torx® Mirror Bracket Wrench is perfect to quickly remove or replace mirrors held in place with Torx® screws. The Torx® 15 tip is great for older Ford and GM models, while the Torx® 20 tip works on newer GM models.

CAT. NO. MB2TX

CRL Mirror Bracket Release Tools

- Quickly Release Rear View Mirrors



CAT. NO. MB3

This CRL Mirror Bracket Spring Release Tool is designed for use with Ford rear view mirror brackets, allowing the mirror to be removed with a slight upward push on the handle of the tool.

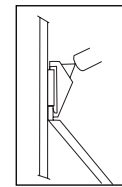

CAT. NO. MB4

This CRL GM Mirror Release Tool is simple to use - just push tab under lip of clip that holds mirror to windshield bracket and pry up gently. Then grasp mirror with free hand and push up and off the bracket.

CRL 6-in-1 Mirror Bracket Tool

- Torx®, Allen, Slotted, and Phillips Bits with Combined Driver Handle/Carrying Case

We have combined the most popular mirror bracket removal and replacement bits along with a driver handle/carrying case in our CRL Six-in-One Mirror Bracket Tool. Together they make up the most versatile mirror bracket tool ever. Housed in this sturdy carrying case are one each:

Cat. Nos. 440TX15 and 440TX20 TX15 and TX20 Torx® Bits;

Cat. Nos. 1815 and 1853 3/32" and 5/64" Allen Bits;

Cat. No. 4453 #8 Slotted Insert Bit;

Cat. No. 4420 #2 Phillips Bit;

Cat. No. M490 Magnetic Insert Bit Holder



CAT. NO. MB6N1

CRL Stick-On Convex Mirror

- Peel and Stick Installation

- Ideal for Truck, RV, and Bus Side View Mirrors



CAT. NO. FS375

Eliminate blind spots and avoid accidents with a CRL Stick-On Convex Mirror. A valuable visual aid while backing, turning, or parking large vehicles, this circular mirror is 3-3/4" (95 mm) in diameter.

CRL Mirror Bracket Iron

- Safely Heats Mirror Brackets
- 10 Second Removal Time



CAT. NO. 90MB1

The CRL Mirror Bracket Iron safely and easily removes most rear view mirror brackets from windshields within 10 seconds. The iron heats only the bracket, unlike other heat removal methods such as torches, which can break the glass or bubble the laminate. 110V AC.

CRL Rear View Mirror Installer

- Installs Spring-Loaded Mirrors with Ease

new



CAT. NO. RM1309

Relieve the stress of mounting spring-loaded mirrors with our Rear View Mirror Installer. It solves this troublesome installation problem so you never have to worry about breaking the windshield or struggle with trying to ensure the mirror is correctly mounted. It's as simple as squeezing the handle and you're done.

CRL Tridon® Metalist® Windshield Wiper Blades

new



- Value Added Service to Your Customers
- Aerodynamic Steel Frame for Strength and Durability
- Engineered for Better Wrap on Highly Curved Windshields
- Precision Cut Rubber Edge Provides Superior Wiping Action
- Pre-attached Adaptor Fits 98% of Vehicles for Quick and Easy Installment

CRL Tridon® Windshield Wiper Blades give you a selection that covers about 98% of the vehicles you service. These blades feature precision cut rubber for a superior wipe, and are engineered for a better wrap on today's highly curved windshields. Installation is quick and easy using the pre-attached adaptors.

Starter Kit Storage Rack and Wiper Blades

- Kit Includes 50 Blades, Shelf Organizer, and Application Chart

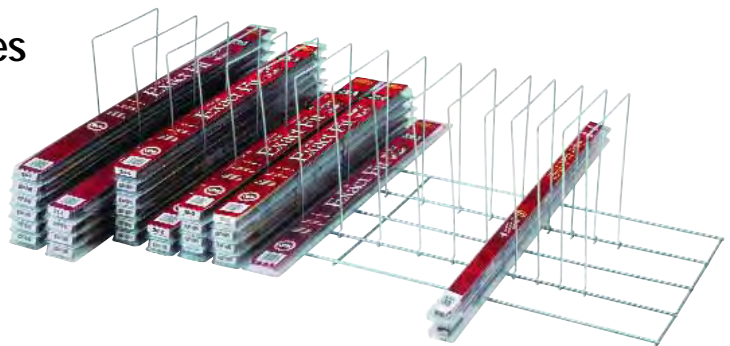

STARTER KIT
CAT. NO. MW99

Keep your stock of Wiper Blades organized and readily accessible with this totally adjustable storage rack system. Sturdy wire base and 17 dividers assemble easily to create custom storage on any standard display shelf.

Capacity: Will Hold Approximately 160 Wiper Blades
Dimensions: 36" Wide by 9" High by 12" Deep

CAT. NO.	DESCRIPTION	QTY
MW15B	15" Windshield Wiper	5 Blades
MW16B	16" Windshield Wiper	5 Blades
MW17B	17" Windshield Wiper	5 Blades
MW18B	18" Windshield Wiper	5 Blades
MW19B	19" Windshield Wiper	5 Blades
MW20B	20" Windshield Wiper	5 Blades
MW21B	21" Windshield Wiper	5 Blades
MW22B	22" Windshield Wiper	5 Blades
MW24B	24" Windshield Wiper	5 Blades
MW28B	28" Windshield Wiper	5 Blades
MW99116	Shelf Organizer	1 Each
MWAC	Application Chart	1 Each

Individual Metalist® Wiper Blades

CAT. NO.	DESCRIPTION	STOCK CODE	QTY/BOX
MW11B	11" Windshield Wiper	C	10
MW13B	13" Windshield Wiper	C	10
MW15B	15" Windshield Wiper	B	10
MW16B	16" Windshield Wiper	A	10
MW17B	17" Windshield Wiper	A	10
MW18B	18" Windshield Wiper	A	10
MW19B	19" Windshield Wiper	A	10
MW20B	20" Windshield Wiper	A	10
MW21B	21" Windshield Wiper	A	10
MW22B	22" Windshield Wiper	A	10
MW24B	24" Windshield Wiper	A	10
MW26B	26" Windshield Wiper	C	10
MW28B	28" Windshield Wiper	B	10
MWAC	Application Chart		

STOCK CODE: A = Best Sellers B = Popular C = Limited Applications

- Pre-Attached Adaptor for Quick and Easy Installation

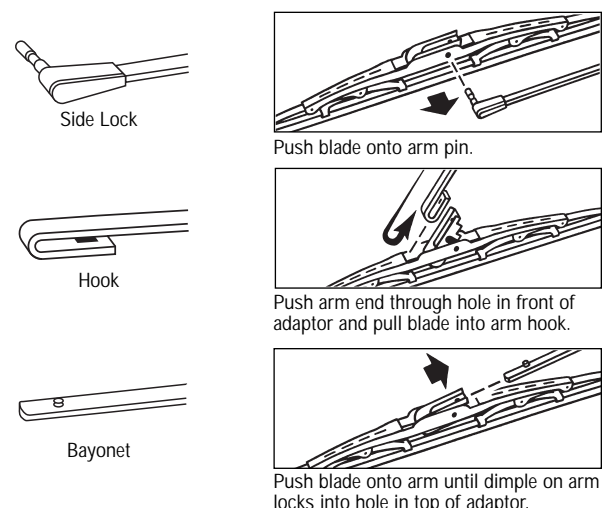

Tridon® and Metalist® are registered trademarks of Trico Products, a Gates Group Company



LOG ON TO crlaurence.com FOR BUSINESS-TO-BUSINESS SERVICES

A238 | PHONE (800) 421-6144 | FAX (800) 262-3299 TOLL FREE FROM ANYWHERE IN THE U.S.A. OR CANADA

CRL Rain and Light Sensor Kit

- Includes Most Common Sensor Brackets, Lenses, and Adhesive Pads

CRL Rain and Light Sensor Brackets, Lenses, and Adhesive Pads are very specific items needed to complete windshield installations on many of today's cars and SUV's. Be prepared with our top-selling CRL Rain and Light Sensor Kit, which contains two each of our most common Brackets, Lenses, and Adhesive Pads. These items are also sold separately as shown on the following pages.



new

Our RL40 Kit contains two each of the following OEM quality items:

CAT. NO. RL40

SENSOR BRACKETS

CAT. NO.	APPLICATION
RSM2289E	1998-2003 VW Beetle (user with Urethane)
RSM2117	1999 - 2003 VW Golf and Jetta
RSM2222	2001 - 2004+ Lexus LS430
RSM2277	2002 - 2003 Lexus ES300
RSM1340	2003 - 2004 Jaguar S-Type; 2002 Lincoln Blackwood
RSM2374	2003 - 2004+ Saab 9 - 3 Series; 1999 - 2003 Saab 9 - 5 Series
RSM1463	2003 - 2004+ Lincoln Town Car; 2003 - 2004+ Volvo XC90; 2001 - 2003 Volvo S60 (with Adhesive)
RSM1448LT	2004+ Chevy SSR; 2002 - 2004+ Chevy Trailblazer; 2002 - 2003 GMC Envoy; 2002+ Oldsmobile Bravada
RSM2408	2004+ VW Touareg; 2004+ Porsche Cayenne

SENSOR LENSES

CAT. NO.	APPLICATION
RCK2255R	1998+ Mercedes-Benz ML Series (Red Lens with Adhesive)
RCK2296B	2000+ BMW 323; 2001+ BMW 325; 2002+ BMW X5 (Blue Lens with Adhesive)
RCK1427	2001+ Buick Park Avenue and LeSabre; 2001+ Cadillac Seville/Deville; 2001+ Oldsmobile Aurora; 2002+ Jeep Grand Cherokee (Lens with Adhesive)
RCK2056	1998 - 2002 Mercedes-Benz E430, E55 AMG, CLK320, CL500; 2000 - 2001 BMW X5 (Lens with Adhesive)

REFURBISHING KITS (CONTAIN ADHESIVE PAD, PRIMER, AND INSTRUCTIONS)

CAT. NO.	APPLICATION
RSK2296	1998+ Mercedes-Benz ML Series; 2000+ BMW 323; 2001+ BMW 325; 2002+ BMW X5
RSK2056	1998 - 2002 Mercedes-Benz E300, E320, E420, E430, E500, E55 AMG, and E320 Wagon
RSK1427	2001+ Buick Park Avenue and LeSabre; 2001+ Cadillac Seville/Deville; 2001+ Oldsmobile Aurora; 2002+ Jeep Grand Cherokee
RSK1229	1996 - 2002 Cadillac Eldorado; 1996 - 1997 Cadillac Seville
RSK2117	2002+ Chevy Trailblazer; 1999 + VW Golf and Jetta
RSK2363	2003 Jaguar S-Type, XK8 Convertible, XKR Convertible

How Sensors Work and Why You Should Know!

Rain and Light Sensors work on refracted light. Most sensors work by focusing a LED beam at an angle to the glass that reflects back to a sensor. Water on the surface of the windshield will alter the beam and send a signal to the wiper and headlight modules to turn on or off. The wiper speed is controlled automatically according to the intensity of the moisture detected.

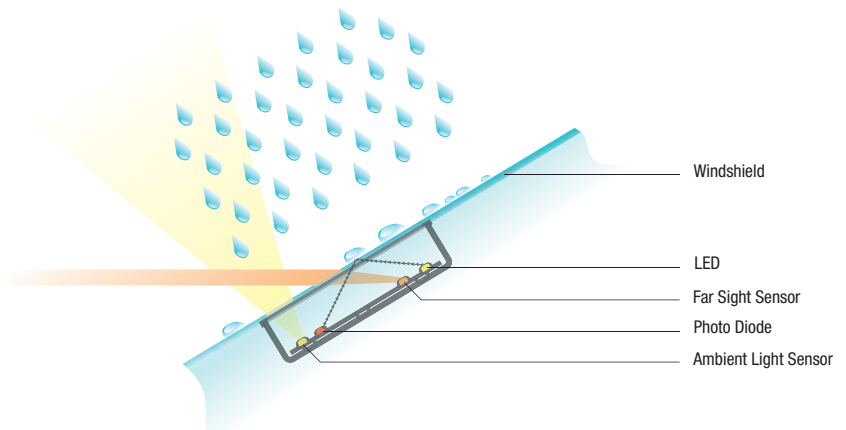

CRL Rain and Light Sensor Brackets **new**

- Most Popular Model-Specific Replacement Hardware for Late Model Vehicles

CRL Rain and Light Sensor Brackets are model specific parts needed to complete windshield installations on many of today's new cars and SUV's. Each of the items shown here are available for individual repair jobs, or as refill parts for our Rain and Light Sensor Kit shown on the previous page.

Rain and Light Sensors for New Models

As new model vehicles arrive the number of Sensors increases. If you don't see the Sensor you need in this catalog check the CRL web site at crlaurence.com. You can also contact our Automotive Technical Center by e-mail techsales@crlaurence.com.

- 2002 - 2004+ Chevy Trailblazer
- 2002 - 2003 GMC Envoy
- 2002+ Oldsmobile Bravada
- 2004+ Chevy SSR



Qty/Pkg 1
CAT. NO. RSM1448LT

- 1998 - 2003 VW Beetle



Use with Urethane
Qty/Pkg 1
CAT. NO. RSM2289E

- 1999 - 2003 VW Golf and Jetta



Qty/Pkg 1
CAT. NO. RSM2117

- 2001 - 2004+ Lexus LS430



Qty/Pkg 1
CAT. NO. RSM2222

- 2002 - 2003 Lexus ES300

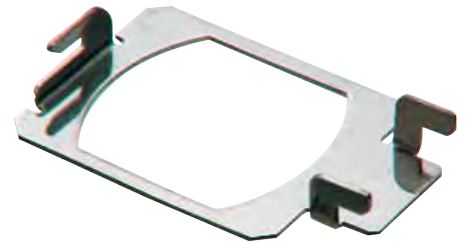

Qty/Pkg 1
CAT. NO. RSM2277

- 2003 - 2004 Jaguar S-Type
- 2002 Lincoln Blackwood



Qty/Pkg 1
CAT. NO. RSM1340

- 2003 - 2004+ Saab 9 - 3 Series
- 1999 - 2003 Saab 9 - 5 Series



Qty/Pkg 1
CAT. NO. RSM2374

- 2003 - 2004+ Lincoln Town Car
- 2003 - 2004+ Volvo XC90
- 2001 - 2003 Volvo S60



Qty/Pkg 1
CAT. NO. RSM1463

- 2004+ VW Touareg
- 2004+ Porsche Cayenne



Qty/Pkg 1
CAT. NO. RSM2408



CRL Rain and Light Sensor Lenses **new**

- **BMW 2000+ 323, 2001+ 325, 2002+ X5**
For use with BMW Module 61 35 6 923 954

Blue Sensor Lens with Adhesive



Qty/Pkg 1

CAT. NO. RCK2296B

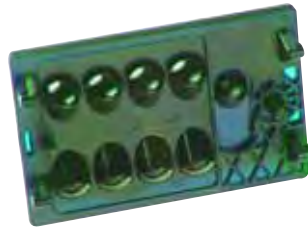

- **1998 - 2002 Mercedes-Benz E430, E55 AMG, CLK320, CL500**
- **2000 - 2001 BMW X5**
For use with BMW Module #61 35 6 904 012
or Mercedes Module #A210 820 5110

Sensor Lens with Adhesive



Qty/Pkg 1

CAT. NO. RCK2056



- **1998+ Mercedes-Benz ML Series**

For use with Mercedes Modules #163 820 01 26
or #163 820 07 26

Red Sensor Lens with Adhesive



Qty/Pkg 1

CAT. NO. RCK2255R



- **2001+ Buick Park Ave and LeSabre**
- **2001+ Cadillac Seville/Deville**
- **2001+ Oldsmobile Aurora**
- **2002+ Jeep Grand Cherokee**

Sensor Lens with Adhesive



Qty/Pkg 1

CAT. NO. RCK1427



CRL Rain and Light Sensor Refurbishing Kits **new**

All Refurbishing Kits contain adhesive, primer, and instructions.

- **BMW 2000+ 323; 2001+ 325; 2002+ X5**
- **1998+ Mercedes-Benz ML Series**



Qty/Pkg 1

CAT. NO. RSK2296

- **1998 - 2002 Mercedes-Benz E300, E320, E420, E430, E500, E55 AMG, and E320 Wagon**



Qty/Pkg 1

CAT. NO. RSK2056

- **2001+ Buick Park Ave and LeSabre**
- **2001+ Cadillac Seville/Deville**
- **2001+ Oldsmobile Aurora**
- **2002+ Jeep Grand Cherokee**



Qty/Pkg 1

CAT. NO. RSK1427

- **1996 - 2002 Cadillac Eldorado**
- **1996 - 1997 Cadillac Seville**



Qty/Pkg 1

CAT. NO. RSK1229

- **2002+ Chevy Trailblazer**
- **1999+ Volkswagen Golf, Jetta**



Qty/Pkg 1

CAT. NO. RSK2117

- **2003 Jaguar S-Type, XK8 and XKR Convertibles**



Qty/Pkg 1

CAT. NO. RSK2363

CRL Rear Defroster Connection Kit

- Easy-to-Use Two-Part Conductive Adhesive for the Repair of Rear Defroster Power Tabs
- Full Cure in 24 Hours or Less

The CRL Rear Defroster Connection Repair Kit is easy to use. Just mix equal parts of Part A Epoxy with Part B Hardener and apply to the rear defroster power tabs (not grids) for quick bonding. Keep immobilized for about 10 minutes. Full cure will be obtained in 24 hours or less, depending on temperature and thickness of material. Always use a minimal amount for fastest cure.

CAT. NO.	CONTENTS
RDCRK	.5 Oz. (14 g) Total



CRL Rear Window Grid Repair Kit

- Conductive Paint-On Repair for Scratched or Broken Rear Defroster Lines
- Easy-to-Use Kit Contains Everything You Need

This CRL Rear Window Grid Repair Kit reliably repairs scratched or broken auto glass defroster lines in minutes. Damaged grid traces are masked off and repaired by applying the Grid Repair Conductive Paint over the damaged area. The conductor dries quickly, and is color-matched to the defroster for nearly invisible repairs.

The kit contains one .35 ounce (10 gram) bottle of Conductive Paint, one 36" by 1/4" (914 mm by 6 mm) roll of Grid Masking Tape, and three Cotton Applicator Swabs.

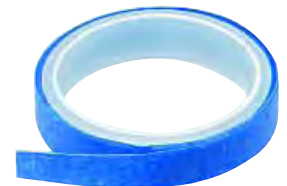

CAT. NO.	CONTENTS
2100RK	.35 Oz. (10 g)

CRL Conductive Pen

new

- Quickly Creates Conductive Silver Traces for Grid Repair
- Valved Pen Tip for Easy Applications
- Dries in Minutes at Room Temperature

This Conductive Pen easily repairs scratched or broken auto glass defroster lines in minutes. Squeeze the pen body while pressing down on the glass and the material flows, allowing the trace to be drawn. Achieves electrical conductivity within only 30 minutes.

CAT. NO.	CONTENTS
CW2200	0.3 Oz. (8.5 g)



LOG ON TO crlaurence.com FOR BUSINESS-TO-BUSINESS SERVICES

A242 | PHONE (800) 421-6144 | FAX (800) 262-3299 TOLL FREE FROM ANYWHERE IN THE U.S.A. OR CANADA

CRL Master Defroster and Antenna Repair Kit

- Repairs Defroster and Antenna Grids
- Reattaches Connector Tabs
- Includes Common Connectors and Pins

This CRL Master Defroster and Antenna Repair Kit fixes the most common problems related to heated automotive glass. The kit includes: Test Lamp Kit; Two-Part Conductive Tab Repair Epoxy to bond the tabs onto the glass forming an electrical and structural connection; Grid Repair for scratched or broken defroster lines; 90° Tab Connectors; Straight Tab Connectors; Replacement Power Tabs. This handy kit pays for itself after just a couple of repairs.



new

CAT. NO.	DESCRIPTION
P2700	Master Defroster Repair Kit



CRL Rear Defroster Test Lamp Kit

- Inexpensive Way to Test Rear Window Defroster Lines
- Locates Small Hard to Find Breaks

The CRL Test Lamp Kit is an inexpensive way to test automotive rear window defrosters and identify broken defroster lines. Uses a 12 volt lamp with two long leads attached and marking tape. Move the leads over the defroster, then watch the lamp to verify defroster is working and to locate those small, hard to find breaks.



new

CAT. NO.	DESCRIPTION
P2400	Rear Defroster Test Lamp Kit



Locate the Problem

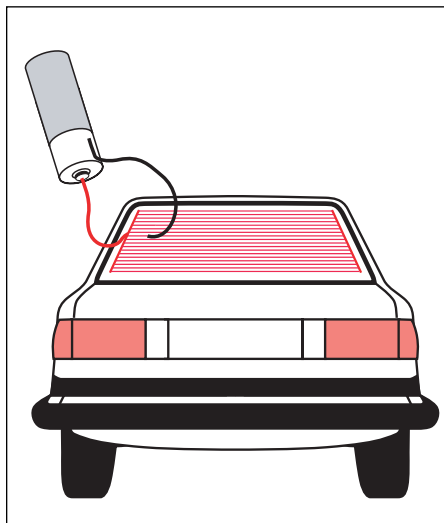

Use Cat. No. P2400

Repair Grid Breaks

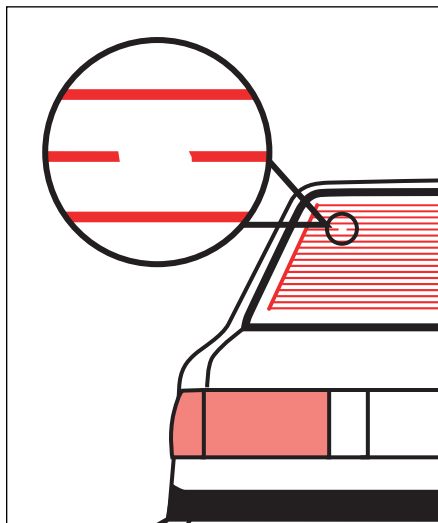

Use Cat. No.'s 2100RK, CW2200 or P2700

Repair Connector Tabs

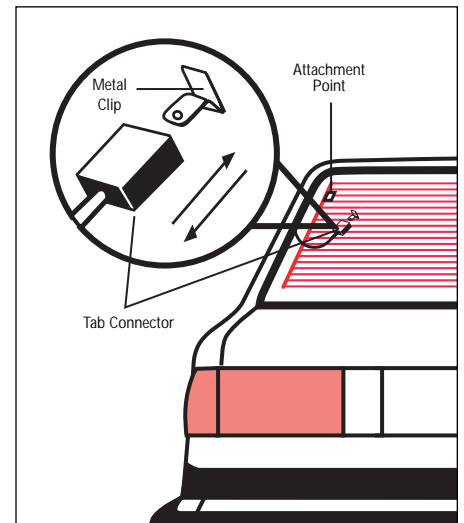

Use Cat. No.'s CW2200, P2700 or RDCRK

CRL Automotive Glass Clips, Fasteners, and Guides

- Stock Your Shop with Our OEM Quality Replacement Parts
- Hundreds of Parts Available for Most Domestic and Import Cars and Trucks

All CRL Automotive Windshield Clips, Reveal Molding Clips, Trim Fasteners, Door Handle Clips, Regulator Rollers, Guides, and Rivets are OEM quality, and we stock the most complete selection anywhere. Whatever make, model or year of car you're working on CRL probably has the clip you need.

Finding the right clip is easy. The page headers identify the make of the car and the type shown on the page. The clips are then pictured in color and identified by particular application by make and model year (where available).



CRL adds new clips and fasteners to our product line on a regular basis. As vehicles become older, aftermarket suppliers start supplying the clips and fasteners that were previously only available from the dealer. Year models shown with a "+" after the date (i.e., 1997+ or 2000+) denotes the fact that these clips or fasteners are available for this model vehicle from that year forward. By visiting crlaurence.com you can search for clips and fasteners by year, make, and model.

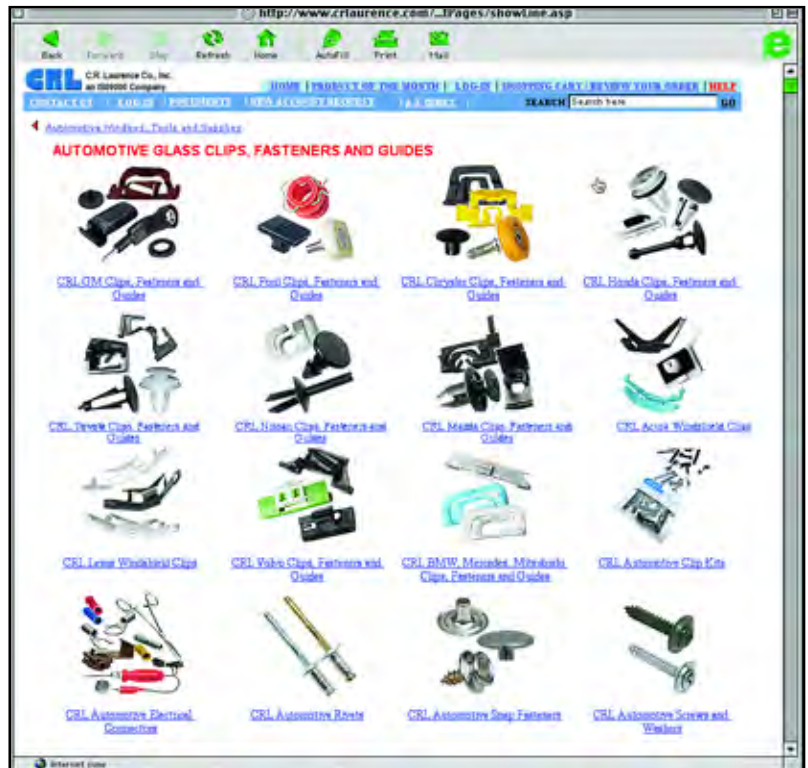

LOG ON TO crlaurence.com FOR BUSINESS-TO-BUSINESS SERVICES

A244 PHONE (800) 421-6144 | FAX (800) 262-3299 TOLL FREE FROM ANYWHERE IN THE U.S.A. OR CANADA

CRL Replacement Clip Kits

CRL Reveal Molding Clip and Screw Stud Kits

- Ford, Chrysler, and GM
- Twelve of the Most Common Molding Clips and Screw Studs in Two Handy Assortment Kits

CRL offers the most popular Reveal Molding Clips and Screw Studs packed together in two handy, presorted kits: one for General Motors cars, and one for Ford and Chrysler cars. Each contains twelve different types of clips and studs (91 pieces per kit), and has a convenient chart inside the lid that easily identifies each part for easy re-ordering.



CAT. NO. AN901
Kit for Ford and Chrysler Cars



CAT. NO. AN900
Kit for GM Cars

CRL Replacement Clip Kits for Japanese-Made Cars

- Most Popular Assorted Body and General Purpose Clips



CAT. NO. CP835665
Belt and Reveal Clips

You will find all the small automotive replacement parts you used to hunt for in one place: this handy, see-through parts box. It has 66 assorted belt and reveal molding clips for Toyota, Honda, Mazda, and other cars. There's even a chart in the lid for easy re-ordering.



CAT. NO. CP835666
Body and General Purpose Clips

This handy, see-through parts box contains 144 assorted body and general purpose clips for Nissan/Datsun, Toyota, and Honda cars. Now you don't have to search through many containers to find the ones you want. And, there's even a convenient chart in the lid for easy re-ordering.

CRL Push In Retainer and Finishing Plug Kit **new**

CRL's Push In Finishing Plugs are used to hold grilles, soft trim, liner panels, insulation, etc. These OEM quality Plugs are ribbed along entire length of shaft, and will work well even in irregularly shaped holes. Head diameters range from 7/16" (11 mm) to 1" (25 mm). Kit contains six different items for a total of 45 pieces in a plastic storage box.



CAT. NO. AN912

CRL Plastic Drive Rivet Kit **new**

CRL's OEM quality Plastic Drive Rivets are designed to attach moldings, cowls, shields, panels, and grilles into blind holes. Rivets come in six sizes to fit hole diameters from 1/8" (3.1 mm) to 5/16" (8 mm). Kit comes in a plastic storage box containing six different items for a total of 55 pieces.



CAT. NO. AN914

CRL Ford/Mercury Windshield and Backglass Molding Clips



Windshield and Backglass Molding Clips
Ford and Mercury '65+, Mustang '66+
AMC '67 - '75, Mazda '74+

Qty/Pkg 100
Cat. No. CP651120



Windshield and Backglass
Molding Clips
Mustang '67+

Qty/Pkg 100
Cat. No. CP663021



Windshield and Backglass Molding Clips
Fairlane, Meteor and Comet '68+
Datsun '70+

Qty/Pkg 100
Cat. No. CP673094



Windshield Molding Clips
Ford Cars '71 - '94
Ford F-Series Trucks '91 - '96

Qty/Pkg 100
Cat. No. CP713467



Windshield Molding Clips
Ford Cars and Vans '78+

Qty/Pkg 100
Cat. No. CP774721



Windshield and Backglass Molding Clips
Topaz, Tempo, T-Bird and Cougar '83+

Qty/Pkg 50
Cat. No. CP835726



Windshield Molding Clips
Mustang and Cougar '66 - '68

Qty/Pkg 100
Cat. No. CP683178



Windshield and Backglass Molding Clips
Mustang '64 - '65

Qty/Pkg 100
Cat. No. CP651071



Windshield Molding Clips
Ford Vans '78+

Qty/Pkg 50
Cat. No. CP784751



Windshield Molding Clips
Ford '79+

Qty/Pkg 50
Cat. No. CP815381



Windshield Molding Clips
Ford '79+

Qty/Pkg 100
Cat. No. CP784940



Windshield Reveal Molding Clips
Ford Festiva '88+

Qty/Pkg 15
Cat. No. CP916882



Windshield Molding Clips
Maverick and Cougar '75+

Qty/Pkg 100
Cat. No. CP744051



Backglass Molding Clips
Ford Probe, Mazda MX6 '88+, Mercury Tracer '87+

Qty/Pkg 25
Cat. No. CP896571



Backglass Molding Clips
Mercury Tracer and Mazda 323 '88+

Qty/Pkg 15
Cat. No. CP906812



CRL Ford/Chrysler Windshield and Backglass Molding Clips



Backglass Molding Clips
Ford Probe '89+

Qty/Pkg 15
CAT. NO. CP906811



Backglass Molding Retainer
Ford '80+

Qty/Pkg 15
CAT. NO. CP977736



Backglass Molding Clips
Ford Tracer and Probe '88+

Qty/Pkg 25
CAT. NO. CP906867



Windshield and Backglass Molding Clips
(Upper and Sides)
Chrysler, Dodge, and Plymouth
'65-'72

Qty/Pkg 25
CAT. NO. CP957418



Backglass Molding Clips
Barracuda '69+, Chrysler '71

Qty/Pkg 50
CAT. NO. CP703370



Windshield Clips
Chrysler LeBaron '87+
Maserati 87+

Qty/Pkg 15
CAT. NO. AV17151



Quarter Window, Windshield and
Backglass Molding Clips
Chrysler Cars '74+
Chrysler Trucks '85+

Qty/Pkg 50
CAT. NO. CP998126



Quarter Window Molding Clips
Chrysler '71+

Qty/Pkg 50
CAT. NO. CP703410



Windshield Molding Clips
Chrysler '68-'72

Qty/Pkg 50
CAT. NO. CP957440



Windshield Clips
Plymouth Arrow Dodge Colt, and
other Japanese Models
'71-'96

Qty/Pkg 25
CAT. NO. CP815374



Windshield and Backglass Molding Clips
Chrysler "K" Cars '84+

Qty/Pkg 25
CAT. NO. AV13567



Windshield Molding Clips
Plymouth Arrow, Dodge Colt
'79-'80

Qty/Pkg 25
CAT. NO. CP815373



Windshield Clips
Dodge Conquest '84+

Qty/Pkg 25
CAT. NO. CP855936



Windshield and Backglass Clips
Jeep CJ/XJ/YJ 78+

Qty/Pkg 100
CAT. NO. CP774711



Windshield Molding Clips
Dodge Daytona '84+

Qty/Pkg 10
CAT. NO. CP886414

CRL Chevy/GM Windshield and Backglass Molding Clips



Windshield Molding Clips
(Upper and Lower) Chevelle '67+

Qty/Pkg 100
CAT. NO. CP683220



Windshield and Backglass Molding Clips
Chevelle, Tempest, F-85, Buick Special '68-'70

Qty/Pkg 100
CAT. NO. AV9633



Windshield and Backglass Molding Clips
Buick, Camaro, Pontiac Tempest '70+

Qty/Pkg 50
CAT. NO. AV10630

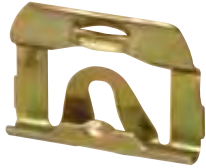

Windshield and Backglass Molding Clips
Impala '69+ and GM '71+

Qty/Pkg 50
CAT. NO. CP998245



Windshield Molding Clips
GM A-Body '72+

Qty/Pkg 100
CAT. NO. CP713494



Windshield Molding Clips
GM '73 - '92

Qty/Pkg 100
CAT. NO. CP723710



Backglass Molding Clips GM '69 - '74
Quarter Glass Molding Clips GM '65+

Qty/Pkg 100
CAT. NO. CP651069



Backglass Molding Clips
GM '66 - '70

Qty/Pkg 50
CAT. NO. CP998425



Backglass Molding Clips
All GM '64-'70

Qty/Pkg 100
CAT. NO. CP673103



Backglass Molding Clips
Caprice/Impala '69+

Qty/Pkg 100
CAT. NO. AV10242



Quarter Glass, Windshield and
Backglass Molding Clips
All GM '64-'71

Qty/Pkg 100
CAT. NO. CP651053



Backglass Molding Clips
GM '74+

Qty/Pkg 100
CAT. NO. AV11427



Backglass Molding Clips
GM '66+

Qty/Pkg 50
CAT. NO. CP663067



Windshield and Backglass Molding Clips
Chevelle, Chevy II, F85, Tempest, Buick Special '68+

Qty/Pkg 50
CAT. NO. CP998420



Windshield Molding Clips
GM '71+

Qty/Pkg 100
CAT. NO. CP713468



CRL Chevy/GM Windshield and Backglass Molding Clips



Rear Glass Lower Garnish Molding Clip
Cutlass, Monte Carlo, Gran Prix
and Regal Coupes '78+

Qty/Pkg 50
CAT. NO. CP805145



Windshield Molding Clips
GM Compact '75+

Qty/Pkg 100
CAT. NO. CP744057



Windshield Molding Clips
GM '76 - '81
AMC '75 - '85

Qty/Pkg 50
CAT. NO. CP733835



Backglass Molding Clips
Buick, Olds Cutlass 88 and 98, '80+

Qty/Pkg 50
CAT. NO. CP805152



Lower Windshield Molding Clips
GM '79+

Qty/Pkg 100
CAT. NO. CP784777



Windshield Molding Clips
Corvette '64-'67

Qty/Pkg 50
CAT. NO. CP805238



Windshield Molding Clips
Corvette '68-'75

Qty/Pkg 25
CAT. NO. CP967397



Windshield Molding Clip
Geo Storm '90+

Qty/Pkg 10
CAT. NO. CP906770



Windshield and Backglass Molding Clips
GM '61-'64

Qty/Pkg 100
CAT. NO. AV2628



Windshield Molding Clips
GM Nova '85+

Qty/Pkg 25
CAT. NO. CP855993



Backglass Molding Clips
GM J-Body '82+

Qty/Pkg 25
CAT. NO. CP855938



Backglass Garnish Molding Clips
GM '80+

Qty/Pkg 10
CAT. NO. AV17666



Quarter Window Clips
Buick, Oldsmobile, Cadillac '77+

Qty/Pkg 50
CAT. NO. CP774536



Quarter Glass Clips
Chevy J-Body '88+

Qty/Pkg 15
CAT. NO. CP896643



Windshield Antenna Connector
Chevy/GMC Trucks '73+

Qty/Pkg 10
CAT. NO. CP733850

CRL Toyota Windshield and Backglass Molding Clips



Windshield Molding Clips
(Lower Left Hand Corner)
Toyota Pickup '88 - '95

Qty/Pkg 10

CAT. NO. CP906874



Windshield Molding Clips
(Upper Left Hand Corner)
Toyota Pickup '88 - '95

Qty/Pkg 10

CAT. NO. CP906872



Windshield Molding Clips
(Upper Right Hand Corner)
Toyota Pickup '88 - '95

Qty/Pkg 10

CAT. NO. CP906871



Windshield Molding Clips
(Lower Right Hand Corner)
Toyota Pickup '88 - '95

Qty/Pkg 10

CAT. NO. CP906873



Windshield Molding Clips
Various Toyota Models

Qty/Pkg 25

CAT. NO. CP835697



Windshield Molding Clips
Toyota Cressida '78 - '80

Qty/Pkg 25

CAT. NO. CP815349



Windshield Molding Clips
(Self-Adhesive)
Toyota Celica '82 - '85

Qty/Pkg 10

CAT. NO. CP835653



Windshield Molding Clips
(Self-Adhesive)
Toyota '82+

Qty/Pkg 25

CAT. NO. CP845754



Backglass Molding Clips
Upper and A-Pillar
Toyota Camry '87 - '91

Qty/Pkg 10

CAT. NO. CP876240

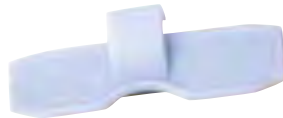

Windshield Molding Clips
(Self-Adhesive)
Toyota Pickup '84+

Qty/Pkg 10

CAT. NO. CP866038



Windshield Molding Clips
(Self-Adhesive)
Toyota Cars and Trucks '83 - '95

Qty/Pkg 25

CAT. NO. CP876243



Windshield Molding Clips
(Left Hand Side Corner)
Toyota Tercel '83 - '88

Qty/Pkg 10

CAT. NO. CP876245



Windshield Molding Clips
Toyota Celica '78 - '81
Cressida '78 - '84

Qty/Pkg 50

CAT. NO. CP815347



Windshield Molding Clips
Toyota Corolla '80 - '83

Qty/Pkg 50

CAT. NO. CP815346



Quarter Window Molding Clips
Toyota Celica/Supra '82+

Qty/Pkg 25

CAT. NO. CP855963



CRL Toyota Windshield and Backglass Molding Clips



Windshield Molding Clips
Toyota Celica '86+

Qty/Pkg 25
CAT. NO. CP876241



Windshield Molding Clips
Toyota Celica '86+

Qty/Pkg 25
CAT. NO. CP876242



Backglass Molding Clips
Toyota Camry '87+

Qty/Pkg 15
CAT. NO. CP896615



Backglass Molding Clips
Toyota Camry '87 - '91

Qty/Pkg 15
CAT. NO. CP896616



Windshield Molding Clips
Toyota Corolla '84+

Qty/Pkg 10
CAT. NO. CP876195



Windshield Molding Clips
Toyota Tercel '87 - '91

Qty/Pkg 25
CAT. NO. CP886382



Windshield Molding Clips
(With Center Tab)
Toyota Truck '88+

Qty/Pkg 15
CAT. NO. CP906869



Windshield Molding Clips
Toyota Corolla Sedan
and Wagon
'88 - '92

Qty/Pkg 15
CAT. NO. CP977711



Windshield Molding Clips
Toyota Camry '92+

Qty/Pkg 10
CAT. NO. CP937175



Windshield Molding Clips
(Without Center Tab)
Toyota Truck '88 - '95

Qty/Pkg 15
CAT. NO. CP906870



Windshield Molding Clips (Upper)
Toyota Cressida '88+

Qty/Pkg 15
CAT. NO. CP916997



Windshield Molding Clips (Side)
Toyota Cressida '88+

Qty/Pkg 15
CAT. NO. CP916998

New Products

CRL adds new clips and fasteners to our product line on a regular basis. As vehicles become older, aftermarket suppliers start supplying the clips and fasteners that were previously only available from the dealer. By visiting crlaurence.com you can search for clips and fasteners by year, make and model.



Windshield Molding Clips
(Upper Right Hand Corner)
Toyota Cressida '88+

Qty/Pkg 10
CAT. NO. CP917000



Windshield Molding Clips
(Upper Left Hand Corner)
Toyota Cressida '88+

Qty/Pkg 10
CAT. NO. CP916999

CRL Toyota and Lexus Windshield Molding Clips



Windshield Molding Clips
Toyota Van '85+

Qty/Pkg 25
CAT. NO. CP866062



Windshield Molding Clips
Cressida '81 - '82

Qty/Pkg 25
CAT. NO. CP835743



Windshield Molding Clips
Toyota Van '84+

Qty/Pkg 25
CAT. NO. CP855931



Windshield Molding Clips
Corolla and Tercel '83+

Qty/Pkg 25
CAT. NO. CP835744



Windshield Molding Clips
Corolla '84 - '88

Qty/Pkg 25
CAT. NO. CP855993



Windshield Molding Clips
Corolla '84 - '88

Qty/Pkg 25
CAT. NO. CP866037



Windshield Molding Clips
Corolla '84+

Qty/Pkg 25
CAT. NO. AV16821



Windshield Molding Clips
Cressida '85+

Qty/Pkg 25
CAT. NO. CP866068



Windshield Molding Clips
Camry '86+

Qty/Pkg 25
CAT. NO. CP866076



Windshield Molding Clips
Toyota Celica '81 - '87

Qty/Pkg 25
CAT. NO. CP835651



Windshield Molding Clips
Lexus ES300 '92 - '96

Qty/Pkg 10
CAT. NO. CP977745



Windshield Molding Clips
Toyota Celica and Supra '82+

Qty/Pkg 25
CAT. NO. CP835652



Windshield Molding Clips
Lexus SC300/400
'92 - '96

Qty/Pkg 10
CAT. NO. CP977743



Windshield Molding Clips
Lexus ES300
'92 - '96

Qty/Pkg 10
CAT. NO. CP977744

CRL Windshield Reveal Molding Clip Tools



CAT. NO. MR215

See Page A261



CRL Honda and Acura Windshield Molding Clips



Windshield Molding Clips
2, 3 and 4 Door Civic '92 - '95

Qty/Pkg 10
CAT. NO. CP977738



Windshield Molding Clips (Side)
Civic '92+

Qty/Pkg 10
CAT. NO. CP937149



Windshield Molding Clips (Side)
Civic '92+

Qty/Pkg 10
CAT. NO. CP937150



Windshield Molding Clips
Honda Accord '94-'98
Acura Legend 2 and 4 Door '91 - '99

Qty/Pkg 10
CAT. NO. CP927006



Windshield Molding Clips
Honda Accord '94-'98
Acura Legend 2 and 4 Door '91 - '99

Qty/Pkg 15
CAT. NO. CP927008

New Products

New model year vehicles are introduced year 'round, and with them new glass and molding clips that aren't always easy to locate. If you need a clip for a new vehicle and you can't find it here go to the CRL web site at crlaurence.com. Our product line is always being updated, and chances are we'll have just what you are looking for.



Windshield Molding Clips
(Use with CP927006)
Accord '94+

Qty/Pkg 10
CAT. NO. CP937205



Windshield Molding Clips
Accord '94+

Qty/Pkg 10
CAT. NO. CP967536



Windshield Molding Clips
Accord '94+

Qty/Pkg 10
CAT. NO. CP937206



Windshield Reveal Molding Clips
(Use with CP927004)
Civic '92+

Qty/Pkg 15
CAT. NO. CP927003



Windshield Molding Clips
(Use with CP927003)
Civic '92+

Qty/Pkg 15
CAT. NO. CP927004



Windshield Molding Clips
Prelude '92 - '94

Qty/Pkg 15
CAT. NO. CP947294



Windshield Molding Clips
Honda '83+

Qty/Pkg 25
CAT. NO. CP845835



Windshield Molding Clips
Honda '83+

Qty/Pkg 25
CAT. NO. CP845836



Windshield Molding Clips
Honda '83+

Qty/Pkg 25
CAT. NO. CP845837



CRL Honda and Acura Windshield Molding Clips



Windshield Molding Clips
Acura Integra 3 and
4 Door '90 -'93

Qty/Pkg 15
CAT. NO. CP947292



Windshield Molding Clips
Accord '84+

Qty/Pkg 25
CAT. NO. CP845804



Windshield Molding Clips
Accord '84+

Qty/Pkg 25
CAT. NO. CP856007



Windshield Molding Clips
(Right Hand Corner)
Accord '94+

Qty/Pkg 5
CAT. NO. CP937209



Windshield Molding Clips
(Left Hand Corner)
Accord '94+

Qty/Pkg 5
CAT. NO. CP937210



Windshield Molding Clips
(Upper and Sides)
Accord '85+

Qty/Pkg 100
CAT. NO. AV9633



Windshield Molding Clips
Accord 4 Door and Wagon '90 - '93

Qty/Pkg 10
CAT. NO. CP957487



Windshield Molding Clips
Accord 4 Door and Wagon '90 - '93

Qty/Pkg 10
CAT. NO. CP957488



Windshield Molding Clips
Accord 4 Door and Wagon '90 - '93

Qty/Pkg 10
CAT. NO. CP957489



Lower Windshield Molding Clips
Prelude '88+

Qty/Pkg 10
CAT. NO. CP896622



Windshield Molding Clips
Accord '84+

Qty/Pkg 25
CAT. NO. CP845807



Windshield Molding Clips
Prelude '83+

Qty/Pkg 25
CAT. NO. CP845777



Windshield Molding Clips
(Use with CP916889)
Accord '90+

Qty/Pkg 10
CAT. NO. CP998046



Windshield Molding Clips
(Use with CP998046)
Accord '90+

Qty/Pkg 15
CAT. NO. CP916889



Windshield Molding Clips
Prelude and Acura Legend 4-Door '88+

Qty/Pkg 10
CAT. NO. CP886403



CRL Honda and Acura Windshield and Backglass Molding Clips



Backglass Molding Clips
(Self-Adhesive)
Accord 4 Door '86+

Qty/Pkg 10
CAT. NO. CP876323



Windshield Molding Clips
(Self-Adhesive)
Accord '84+

Qty/Pkg 25
CAT. NO. CP845815



Windshield Molding Clips
Accord '85+

Qty/Pkg 10
CAT. NO. CP855978



Windshield Molding Clips
(Self-Adhesive)
Accord '84+

Qty/Pkg 10
CAT. NO. CP855960



Windshield Molding Clips
Civic '93+

Qty/Pkg 5
CAT. NO. CP967535



Windshield Molding Clips (Upper)
Accord 4 Door '86+

Qty/Pkg 25
CAT. NO. CP866035



Windshield Molding Clips
Accord '94+

Qty/Pkg 5
CAT. NO. CP937207



Windshield Molding Clips
Accord '94+

Qty/Pkg 5
CAT. NO. CP937208



Windshield Molding
Self-Adhesive Strip
Honda '83+

Qty/Pkg 10
CAT. NO. CP845834



Windshield Molding Clips
Acura Legend 2 Door '87

Qty/Pkg 10
CAT. NO. CP886400



Windshield Molding Clips
Acura Legend '91+
Honda Accord '90+

Qty/Pkg 10
CAT. NO. AV17282



Windshield Molding Clips
Acura Legend '88+

Qty/Pkg 25
CAT. NO. CP886408



Windshield Molding Clips
Acura Legend 2 Door '91-'95

Qty/Pkg 5
CAT. NO. CP947328



Windshield Molding Clips
Acura Legend 2 Door '91-'95

Qty/Pkg 5
CAT. NO. CP947327

Part Matching

Sometimes you need a special clip or fastener that even the dealership can't supply. Where do you turn? CRL Automotive Technical Sales can help you find the right part to finish a repair with "as good as new" results. For part matching assistance contact them by e-mail at techsales@crlaurence.com, or call toll free (800) 421-6144, and ask for Extension 7780.



CRL Acura Windshield Molding Clips



Windshield Molding Clips
(Use with CP927006)
Acura Legend 2 and 4 Door '91-'99

Qty/Pkg 10
CAT. NO. CP927007



Windshield Molding Clips
Acura Legend Coupe '91-'95

Qty/Pkg 10
CAT. NO. CP947289



Windshield Molding Clips
Acura Legend Coupe '91-'95

Qty/Pkg 5
CAT. NO. CP947290



Windshield Molding Clips
Acura Legend 2 Door '91-'95

Qty/Pkg 5
CAT. NO. CP947291



Windshield Molding Clips
Acura Integra 3 and 4 Door '90-'95

Qty/Pkg 15
CAT. NO. CP947293



Windshield Molding Clips
Acura Legend '91-'95

Qty/Pkg 5
CAT. NO. CP967534



Windshield Molding Clips
(Use with CP927008)
Acura Legend 2 and 4 Door '91+

Qty/Pkg 15
CAT. NO. CP927009



Windshield Molding Clips
Acura Vigor '92-'94

Qty/Pkg 10
CAT. NO. CP927031



Windshield Molding Clips
Acura Integra '90-'93

Qty/Pkg 5
CAT. NO. CP947321



Windshield Molding Clips
Acura Integra '90-'93

Qty/Pkg 5
CAT. NO. CP947320



Windshield Molding Clips
Acura Legend 4 Door '91-'95

Qty/Pkg 5
CAT. NO. CP947323



Windshield Molding Clips
Acura Integra '90-'93

Qty/Pkg 10
CAT. NO. CP947301



Windshield Molding Clips
Acura Legend 4 Door '91-'95

Qty/Pkg 10
CAT. NO. CP927010



Windshield Molding Clips
Acura Legend '91-'95

Qty/Pkg 10
CAT. NO. CP967533

Windshield Adhesives



CRL has an extensive assortment of Urethane Windshield Adhesives in a variety of formulas to meet Federal Motor Vehicle Safety Standards and OEM requirements. For full details, and a guide to easy selection, turn to pages A110 through A123.



CRL Honda, Acura, and Nissan Windshield and Backglass Clips



Backglass Molding Grommet (with Seal - Lower)
Civic '92+ and Accord '94+
(Use with CP947213)
7mm Hole

Qty/Pkg 10
CAT. NO. CP947212



Backglass Molding Pin Retainer
Civic '92+ and Accord '94+
(Use with CP947212)
12 mm Head

Qty/Pkg 15
CAT. NO. CP947213



Quarter Glass Molding Clip
Acura Integra '86 -'89

Qty/Pkg 5
CAT. NO. CP967510



Backglass Molding Clips
(with Screw and Sealer)
Accord Coupe '90+

Qty/Pkg 5
CAT. NO. AV18112



Backglass Molding Clips
(with Screw and Sealer)
Accord 4 Door '90+

Qty/Pkg 5
CAT. NO. CP927095



Quarter Window Clips
(Self-Adhesive)
Prelude '83+

Qty/Pkg 10
CAT. NO. CP866039



Windshield Molding Clips
Nissan/Datsun

Qty/Pkg 15
CAT. NO. AV15470



Roof Side Molding Clips
Nissan Stanza '90+

Qty/Pkg 25
CAT. NO. CP916907



Windshield Molding Clips
Nissan 300 ZX '84+

Qty/Pkg 25
CAT. NO. CP845880



Windshield Molding Clips
Nissan 300 ZX 90+

Qty/Pkg 15
CAT. NO. CP916951



Backglass Molding Clips
Nissan Maxima '90+

Qty/Pkg 25
CAT. NO. CP916950



Windshield Molding Clips
Datsun 200SX,
Datsun 710 '77-'79

Qty/Pkg 50
CAT. NO. CP794988



Windshield A-Pillar Grommet with Sealer
Nissan Maxima '90+

Qty/Pkg 15
CAT. NO. CP916948

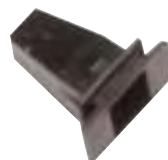

Windshield Molding Retainer Grommet
(Lower Corner)
Nissan Pathfinder '90+
(Use with CP916901)

Qty/Pkg 15
CAT. NO. CP916900



Windshield Molding Fastener
Nissan Pathfinder '90+
(Use with CP916900)

Qty/Pkg 25
CAT. NO. CP916901

CRL Honda and Acura Windshield and Backglass Clips



Windshield Molding Clips
(Use with CP927034)
Acura Vigor '92-'94

Qty/Pkg 25
CAT. NO. CP927033



Windshield Molding Clips
Acura Vigor '92-'94

Qty/Pkg 25
CAT. NO. CP927030



Windshield Molding Clips
Accord '86 - '90
Acura Legend 2 Door '88 - '90

Qty/Pkg 10
CAT. NO. CP886401



Windshield Molding Clips
(Use with CP927033)
Acura Vigor '92-'94

Qty/Pkg 25
CAT. NO. CP927034



Windshield Molding Clips
Acura Legend '91-'95

Qty/Pkg 10
CAT. NO. CP957485



Backglass Molding Clips
Accord '84+

Qty/Pkg 25
CAT. NO. CP845809



Windshield Molding Clips
(Right Hand Corner)
Prelude '92-'94

Qty/Pkg 5
CAT. NO. CP947295



Windshield Molding Clips
(Left Hand Corner)
Prelude '92-'94

Qty/Pkg 5
CAT. NO. CP947296



Windshield Molding Clips
(with Seal)
Acura Legend '91+

Qty/Pkg 5
CAT. NO. CP947259

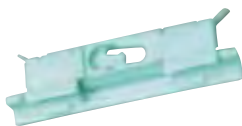

Backglass Molding Clips
Accord '90+

Qty/Pkg 10
CAT. NO. CP987771



Backglass Molding Clips (Upper)
Accord 4 Door '88+

Qty/Pkg 25
CAT. NO. CP896646



Backglass Molding Clips
Civic Hatchback '84+

Qty/Pkg 25
CAT. NO. CP845808



Backglass Side Molding Clips
Accord '90+

Qty/Pkg 10
CAT. NO. CP916916



Backglass Molding Clips
Prelude '88-'89

Qty/Pkg 10
CAT. NO. CP906809



Backglass Molding Clips
Accord 3 and 4 Door '86+

Qty/Pkg 25
CAT. NO. CP876321



CRL Windshield Clips for Various Japanese Cars



Windshield Molding Clips
(Front and Rear)
Mazda 929, '92 - '95

Qty/Pkg 10
CAT. NO. CP977740



Windshield Molding Clips (Side)
Mazda 929, '92 - '95

Qty/Pkg 10
CAT. NO. CP977741



Windshield Molding Clips
Mazda MPV Van '89+

Qty/Pkg 10
CAT. NO. CP916892



Windshield Molding Clips (Upper)
Mazda 626 2 Door '86+

Qty/Pkg 15
CAT. NO. CP876329



Windshield Molding Clips
Mazda 626 2 Door '86+

Qty/Pkg 15
CAT. NO. CP876328



Windshield Molding Clips
Mazda Truck '86+

Qty/Pkg 25
CAT. NO. CP856009



Backglass Molding Clips
Mazda 323 '88+
Mercury Tracer '88+

Qty/Pkg 15
CAT. NO. CP906812



Backglass Molding Clips
Mazda MX6 '88+
Ford Probe '88+
Mercury Tracer '87+

Qty/Pkg 25
CAT. NO. CP896571



Windshield Molding Clips
Mazda '83+

Qty/Pkg 25
CAT. NO. CP845851



Windshield Molding Clips
Mazda RX7 '84 - '85

Qty/Pkg 25
CAT. NO. CP815391



Windshield Molding Clips
Mitsubishi Starion '84+
Hyundai Sonata '88+

Qty/Pkg 25
CAT. NO. CP855936



Windshield Pillar Post Clips
Mazda RX7 '79+

Qty/Pkg 25
CAT. NO. CP835689



Windshield Molding Clips
Mitsubishi Montero '92-'95

Qty/Pkg 10
CAT. NO. CP977742



Windshield Molding Clips
Plymouth Arrow, Dodge Colt,
'79 - '80

Qty/Pkg 25
CAT. NO. CP815373



Windshield Molding Clips
Honda Accord
'82 - '83

Qty/Pkg 25
CAT. NO. CP815374

CRL European Import Windshield Molding Clips and Setting Blocks



Windshield Molding Clips
(Sliding Center)
Volvo 240/260
'78-'90

Qty/Pkg 25
CAT. NO. CP794983



Windshield Molding Clips
(Stationary Center)
Volvo 240/260
'78-'90

Qty/Pkg 25
CAT. NO. CP794984

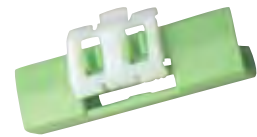

Windshield Molding Clips
(Sliding Center)
Volvo 240/260
'78-'90

Qty/Pkg 25
CAT. NO. CP794985



Windshield Molding Clips
(Stationary Center)
Volvo 240/260
'78-'90

Qty/Pkg 50
CAT. NO. CP794986



Windshield Molding Clips
(Upper and Side)
Volvo '83+

Qty/Pkg 25
CAT. NO. CP845843



Windshield Molding Clips
(Upper and Side)
Volvo 740, 760, 940, 960, S-90 and V90
'85-'98

Qty/Pkg 25
CAT. NO. CP876238



Windshield Molding Clips (Lower)
Volvo 740 and 760 '85+

Qty/Pkg 25
CAT. NO. AV17313



Windshield Reveal Molding Clips
Audi 4000 and Quattro
'85-'87

Qty/Pkg 50
CAT. NO. CP825480



Windshield Molding Clips
BMW 7 Series '87+

Qty/Pkg 15
CAT. NO. CP886441

CRL Windshield Setting Blocks



Windshield Supports
(Three Position Adjustment)
GM 'B' Bodies '80+

Qty/Pkg 50
CAT. NO. CP855889



Windshield Supports
(Five Hole Adjustment)
Various GM

Qty/Pkg 10
CAT. NO. CP937138



Windshield Supports
(Two Hole Adjustment)
Various GM '77+

Qty/Pkg 50
CAT. NO. CP855939



Windshield Spacer Blocks
(Adjustable Style)
Ford (Most Models) '80+

Qty/Pkg 10
CAT. NO. CP876246



3/8" x 1/2" x 1"
80 Durometer Neoprene Rubber
Windshield Setting Blocks
For Use on Vehicles Without
Support Brackets

Qty/Pkg 100
CAT. NO. SB586



Windshield Setting Blocks
Dodge Caravan and
Chrysler Vans '86+

Qty/Pkg 25
CAT. NO. CVSB50



CRL Auto Glass Molding Release Tool

- For General Motors, Ford, and AMC
- Left and Right Handed

Made from tempered high carbon steel, the CRL Molding Release Tool is used to remove trim moldings from General Motors, Ford, and other vehicles. Easy to grip handle provides comfortable prying force.



CAT. NO. KD2038

CRL Window Molding Clip Tool for Chrysler

- For "Standard" Chrysler Clips and Gasket Set Glass



CAT. NO. KD2037

One end of the CRL Window Molding Clip Tool for Chrysler spreads rubber zipper type gaskets, the other end removes "standard" Chrysler clips.

CRL Universal Auto Glass Molding Release Tool

- Angled for Easy Clip Release



Made from tempered high-carbon steel, the CRL Universal Auto Glass Molding Release Tool is used to remove trim moldings and is our most popular molding release tool. Available in standard and Heavy-Duty models.

CAT. NO.	DESCRIPTION
MR215	Standard Release Tool
MR215EXP	Heavy-Duty Release Tool

CRL "Tree" Molding Removal Tool

- Coated Tip Won't Chip Glass
- Removes Insert Moldings



CAT. NO. RFN683

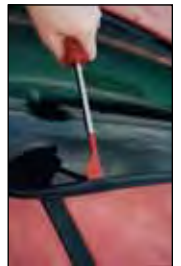

CRL "Tree" Molding Removal Tool makes a difficult job easier. The tool is thin enough to fit under moldings, and wide enough so the tool will not tear the molding. The wide tip is coated so it prevents breakage of the glass.

CRL Molding Release Tools for GM Vehicles

- Release Moldings from Retainer Clips

Right Handed Flat Tip Tool



CAT. NO. CP259

Double Ended Flat Tip Tool



CAT. NO. CP296

Left Handed Flat Tip Tool

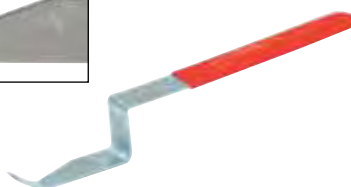

CAT. NO. CP261

Double Ended Angled Tip Tool for Deep Aluminum Moldings



CAT. NO. CP295

CRL Toyota, Honda, Infiniti, Acura, and Subaru Clip Remover Tool new

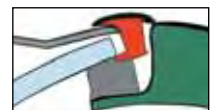

CAT. NO. TCR370

This handy tool serves two functions. It pries open difficult to remove molding retainers, and also depresses "butterfly" clips so they release from the pinchweld retainers.

CRL Wiper Puller

- Removes Pressure Fit Wiper Arms
- Eliminates Breakage or Damage

The CRL Wiper Puller eliminates wiper removal problems. Remove the wiper nut, slide the tool over the arm until the jaws touch the wiper post, and then turn the T-handle clockwise until the wiper arm pops from the wiper post.



CAT. NO. L54150

CRL Windshield Wiper Arm Remover Tool

- Plastic Coated Jaw Protects Car Surface from Scratches
- Squeeze Grip Quickly Pulls Fastener

This CRL Windshield Wiper Arm Remover Tool removes wiper arm without scratching painted surface. Bottom of jaw is coated with a protective plastic. Simply insert jaws between base of wiper arm and attachment surface and squeeze. The wiper arm is off in seconds.



CAT. NO. KD2039

CRL Extra Finger Tool

- Holds Vinyl or Aluminum Glue-In Windshield Moldings in Place
- Adjustable Pressure
- Double Suction Cups Provide Sure Grip



CAT. NO. 81525

Our CRL Extra Finger Tool comes in handy on the many new cars that have a filler strip that must be securely held at the corners while the windshield adhesive is curing. Secure it to the windshield with the double vacuum cups with the threaded "finger" over the filler strip. Tighten the finger, secure filler strip, and walk away. The CRL Extra Finger holds it in place.

CRL Windshield Wiper Arm Removal Tool

- Makes Wiper Arm Removal an Easy Job
- Works with Most Wiper Arms



CAT. NO. 65750

This CRL Windshield Wiper Arm Removal Tool removes wiper arms without damage to the automobile's finish. Simply place the "hook" under the arm base, lift the wiper arm and tool handle together. Wiper arm lifts right off.

CRL Wiper Arm Puller

- Easily Removes Pressure Fit Wiper Arms
- Prevents Damage



CAT. NO. WDZ706

This CRL Wiper Puller eliminates wiper removal problems on most vehicles. Remove the wiper nut, slide the tool over the arm until the metal strap is under the wiper arm. Tighten the adjustable bolt on the wiper bolt, then push down on the handle until the wiper arm pops from the wiper post.

CRL Suck-N-Clamp

- "Hands-Free" Clamping of Windshield and Side Moldings, Emblems and More

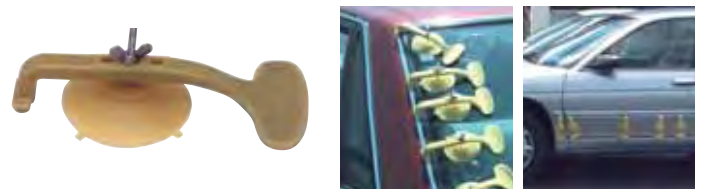





The CRL Suck-N-Clamp provides "Hands-Free" clamping action for glue-on windshield and side moldings, body emblems and more. Suck-N-Clamp works by attaching the suction cup to any smooth, non-porous glass or metal surface. Then the arm is positioned over the item being bonded, and tightened to hold it in position while the adhesive cures. Available individually or in a six-pack.

CAT. NO.	DESCRIPTION
SC1	Suck-N-Clamp Single-Pack
SC6	Suck-N-Clamp Six-Pack



CRL Ford Cowl Fasteners

 <p>Pin, Cowl Screen Retainer; Plastic Grommet (Use with CP886507, CP886508) Mazda 626, MX6 '88+, Ford Probe '88+</p> <p>Qty/Pkg 25 CAT. NO. CP886506</p>	 <p>Grommet, Cowl Screen Retainer; Right Hand Plastic (Use with CP886506 Pin); Round Opening Mazda 626, MX6 '88+, Ford Probe '88+</p> <p>Qty/Pkg 25 CAT. NO. CP886507</p>	 <p>Grommet, Cowl Screen Retainer; Left Hand Plastic (Use with No. CP886506 Pin); Oval Opening Mazda 626, MX6 '88+ and Ford Probe '88+</p> <p>Qty/Pkg 25 CAT. NO. CP886508</p>
 <p>Screw, Cowl Screen Retainer; Black Plastic; Stem Length: 26 mm; Head Dia.: 14 mm Ford Taurus, Sable '96+</p> <p>Qty/Pkg 50 CAT. NO. CP987806</p>	 <p>new</p> <p>Retainer - Cowl Vent Plastic with Black Matte Finish; Hole: 6.3 mm; Head Diameter: 17.4 mm; O/A Length: 22.2 mm Ford Full Size '92+</p> <p>Qty/Pkg 50 CAT. NO. CP998054</p>	 <p>Plastic Grommet and Metal Screw Assembly, Cowl Grille; Hole: 8 mm x 10 mm; Washer Face: 11 mm Grip Range: 0.8 mm- 3.0 mm Ford Contour and Mercury Mystique '95+ and Cougar '99+</p> <p>Qty/Pkg 5 CAT. NO. CP957375</p>
 <p>new</p> <p>Rivet - Drive Type (Push to Release) Cowl Grille and Lower Radiator Opening Cover, Plastic, with Seal Hole: 9 mm; Shoulder: 3 x 10 mm; Flange: 25 mm; Stem Length: 13 mm Lincoln LS 2000+</p> <p>Qty/Pkg 10 CAT. NO. CP998265</p>	 <p>new</p> <p>Cowl Vent Retainer; Plastic Ford Focus 2000+</p> <p>Qty/Pkg 25 CAT. NO. CP998235</p>	 <p>Blind Rivet; Super Tough Nylon, Black; Cowl Vent Grille Rectangular Head 8 mm x 15 mm, Rivet Dia: 4 mm; Grip Range: 6.0 - 10.5 mm Ford Aerostar '86+</p> <p>Qty/Pkg 25 CAT. NO. CP866092</p>
 <p>Screw Cover, Cowl Screen; Small Round; Black Plastic Ford Escort '91+</p> <p>Qty/Pkg 15 CAT. NO. CP977753</p>	 <p>new</p> <p>Cover, Cowl Screw; Large Oval; Plastic Ford Escort '91+</p> <p>Qty/Pkg 15 CAT. NO. CP977752</p>	 <p>Grommet, Cowl Screen with Sealer; Gray Plastic; 10 mm Sq. Hole; 4 mm Screw; Flange 24 x 24 mm; Ford Escort and Tracer '91+ and Escape '01+</p> <p>Qty/Pkg 15 CAT. NO. CP937151</p>
 <p>Grommet Nut; Green Plastic; Cowl and Various Trim Panels Flange 20 mm; Screw Size 4.8 mm; Hole: 11.5 x 8.2 mm Cowl and Various Trim Panels Ford Contour and Mercury Mystique '95+</p> <p>Qty/Pkg 25 CAT. NO. CP957368</p>	 <p>new</p> <p>Retainer - Cowl Grille; Plastic Hole: 1/4"; Head Diameter: 11/16"; Stem: 1-1/8" GM, Ford, Chrysler</p> <p>Qty/Pkg 50 CAT. NO. CP957387</p>	 <p>new</p> <p>Retainer - Cowl Splash Shield and Wire Retainer; Plastic Hole: 63 mm; Head: 10 x 25 mm; Panel Range: 1-9 mm Ford and GM '70+</p> <p>Qty/Pkg 50 CAT. NO. CP998026</p>

CRL Chevy/GMC Cowl Fasteners



Rivet, Drive Type (Removable)
Cowl Screen Retainer; Black Plastic;
6 mm Hole Size; Washer Face 15 mm;
Grip Range 2 - 5 mm;
GM Geo Tracker and Suzuki Sidekick '89+
Toyota RAV4 '89+;
Chrysler and Mitsubishi '95+

Qty/Pkg 10
CAT. NO. CP906806



Cowl Screen Retainer; Black Plastic
Hole Dia. 7/32"; Length 1-3/8";
Head Dia. 19/32"
GM B-Bodies '91+

Qty/Pkg 25
CAT. NO. CP906798



Cowl Vent Rivet, Drive Type;
Black Plastic; Hole: 6 mm
Flange: 15 mm; Panel Range: 5 mm
GM Saturn '91+

Qty/Pkg 25
CAT. NO. CP927025



new

Retainer - Cowl Vent;
Plastic-Textured Head
Hole: 5 mm; Head: 14 mm; Panel Range: 8.5 mm
Chevrolet Tracker and Suzuki Vitara '99+

Qty/Pkg 25
CAT. NO. CP998302



Retainer, Cowl Vent; .185" Hole
GM Fiero P-Body '84+

Qty/Pkg 25
CAT. NO. CP845795



Plastic Retainer, Grille to Shroud,
Vent Grille to Windshield Shroud
GM N and L Bodies '85+

Qty/Pkg 100
CAT. NO. CP855937



Vent Grille Panel Retainer;
Head Dia.: 19/32"; Stem Length: 3/4";
Fits Into 1/8" Hole
Various GM '85+

Qty/Pkg 50
CAT. NO. AV15367



Rear Hood Seal Retainer;
Black Nylon; Head Dia: 3/4";
Stem Length: 1-3/8";
Fits Into 3/16" Hole
Various GM '83+

Qty/Pkg 25
CAT. NO. AV14036



Cowl Screen Fastener;
7 mm Hole; Head Diameter: 15 mm;
Panel Range: 2-5 mm;
GM Fiero '87+

Qty/Pkg 25
CAT. NO. CP998069



new

Retainer - Vinyl Splash Shield;
Radiator to Bar, Cowl Vents
Hole: 3/8"; Head: 1"
GM '80+

Qty/Pkg 50
CAT. NO. CP805158



Retainer, Cowl Screen; Plastic
Hole: 3.5 mm; Head Dia. 8.0 mm;
Panel Thickness: 5 mm
GM Spectrum and Isuzu '85+

Qty/Pkg 100
CAT. NO. CP876326



new

Rivet - Drive Type, Cowl
Intake Splash Shield,
Grille and Front Bumper, General Usage
Hole: 6.3 mm; Flange: 25 mm; Black Plastic
Ford '83+, GM P, N and Y Bodies '84+

Qty/Pkg 25
CAT. NO. CP835636



Cowl Vent Retainer; Black Rubber
Hole Dia: 7 mm; Head Dia.: 25 mm
GM, Cadillac '97+

Qty/Pkg 10
CAT. NO. CP977678



new

Retainer - Cowl Vent, Plastic
Hole: 7 mm; Head: 12 x 15 mm;
Panel Range: 3 mm
Chevrolet Tracker and Suzuki Vitara '99+

Qty/Pkg 25
CAT. NO. CP998301



Grommet, Cowl Retainer; Black Plastic
Fits 5 mm Stud; Washer Dia.: 20 mm;
Across the Flats 10 mm
GM W-Bodies '96+

Qty/Pkg 25
CAT. NO. CP967563



CRL GMC/Chrysler/Toyota Cowl Fasteners

 <p>Retainer - Vent Grille to Windshield Shroud; Plastic GM W-Bodies '88+</p> <p>Qty/Pkg 50 CAT. NO. CP876352</p>	 <p>Grommet Nut, Cowl Screen Retainer; Plastic GM Mini Van '85+, Pickup '88+</p> <p>Qty/Pkg 25 CAT. NO. CP886410</p>	 <p>Retainer - Cowl Screen Black Plastic Chrysler Minivans '91+</p> <p>Qty/Pkg 25 CAT. NO. CP937183</p>
 <p>Retainer - Cowl Screen with Torx Recess (Use with CP947253); Black Plastic; Fits 1/4-20 Stud Dodge Ram Full Size Pickup '94+ Grand Cherokee '99+</p> <p>Qty/Pkg 15 CAT. NO. CP947254</p>	 <p>new</p> <p>Rivet-Cowl and Various Interior Trim Applications (Screw Type); Black Plastic; Hole: 6.3 mm; 2.5 mm - 8.0 mm Grip Range; Washer Face Dia.: 18.0 mm Ford, GM, Chrysler Products, and Cadillac '98+</p> <p>Qty/Pkg 25 CAT. NO. CP866096</p>	 <p>Nut, Cowl Screen; Black Plastic 7 mm Square Hole; 4.2 mm Screw Chrysler Minivans and Various Cars '90+</p> <p>Qty/Pkg 25 CAT. NO. CP927005</p>
 <p>Rivet, Screw Type Cowl Screen; Black Plastic; Hole: 1/4" Square; 15/32" Washer Face Chrysler LH Models '93+ PT Cruiser '01+</p> <p>Qty/Pkg 15 CAT. NO. CP937176</p>	 <p>Cowl Screen Attachment Rivet Screw Type: Plastic 1/4" Square Hole; 7/16" Washer Head; 3/4"-7/8" Panel Range Chrysler A-Bodies '88+</p> <p>Qty/Pkg 25 CAT. NO. CP876303</p>	 <p>Retainer, Cowl Screen (Outer Corners), Black Plastic Chrysler LH Models '93+</p> <p>Qty/Pkg 15 CAT. NO. CP937177</p>
 <p>Retainer - Cowl Screen (Use with CP947254) Black Plastic; Hole Size: 1/4-20" 9/16" Flange; Length: 1"; Dodge Ram Full Size Pickup '94+</p> <p>Qty/Pkg 15 CAT. NO. CP947253</p>	 <p>new</p> <p>Rivet - Drive Type (Re-useable) Cowl Vent; Plastic; Hole: 7 mm, Flange: 15 mm; Stem Length: 20 mm; Panel Range: 12-15 mm Toyota RAV4 '02+</p> <p>Qty/Pkg 15 CAT. NO. CP998280</p>	 <p>new</p> <p>Rivet - Drive Type (Re-useable) Cowl Vent; Plastic; Hole: 7 mm; Flange: 15 mm; Stem Length: 9 mm; Panel Range: 2-5 mm Toyota RAV4 '02+</p> <p>Qty/Pkg 15 CAT. NO. CP998279</p>
 <p>new</p> <p>Rivet - Drive Type (Re-useable) Cowl Vent; Plastic; Hole: 7 mm; Flange: 20 mm; Stem Length: 8.5 mm; Panel Range: 5 mm Toyota RAV4 '02+</p> <p>Qty/Pkg 15 CAT. NO. CP998281</p>	 <p>new</p> <p>Grommet - Cowl Vent; Plastic (Use with CP998149) Hole: 8 mm, Flange: 15 mm Toyota 4 Runner, Tacoma, Pre-Runner, Tundra '95+</p> <p>Qty/Pkg 15 CAT. NO. CP998148</p>	 <p>new</p> <p>Pin Retainer - Cowl Vent; Plastic (Use with CP998148) Head: 13 mm (Textured); Stem Length: 15 mm Toyota 4 Runner, Tacoma, Pre-Runner, Tundra '95+</p> <p>Qty/Pkg 15 CAT. NO. CP998149</p>

CRL Toyota/Lexus/Honda/Acura Cowl Fasteners



new

Rivet - Drive Type, Phillips Head
Cowl Grille and Trunk Trim; Plastic
Hole: 7 mm; Flange: 16 mm; Panel Range: 3 mm
Toyota Solara '99+, Lexus ES300 '97+

Qty/Pkg 10
CAT. NO. CP997911



new

Rivet - Drive Type (Push to Release)
Cowl Grille; Plastic
Hole: 7 mm; Flange: 17 mm; Panel Range: 3 mm
Lexus '97+, Toyota Camry '98 and Prius '01+

Qty/Pkg 10
CAT. NO. CP987856



Retainer, Cowl Grille; Black Plastic
Hole: 8 mm; Head Dia.: 17 mm
Honda Accord '90+

Qty/Pkg 10
CAT. NO. CP916996



Rivet, Screw Type, Cowl Vent Panel
Black Plastic; Air Scoop Grille
Hole: 6 mm
Panel Range: 2.0 - 6.0 mm;
Washer Face: 13 mm
Honda Prelude '83+

Qty/Pkg 25
CAT. NO. CP866079



Retainer, Cowl Grille; Black Plastic
Fits 7 mm Hole; Head 17.5 mm;
Panel Thickness: .80 mm
Honda Civic '92+, CRV '97+

Qty/Pkg 10
CAT. NO. CP967529



new

Cowl Vent Retainer
Hole: 4.2 mm; O/L: 18 mm;
Upper Head: 12 mm; Panel Range: 2.7 mm
Acura MDX, Honda Civic, Insight,
Odyssey and Prelude '95+

Qty/Pkg 10
CAT. NO. CP998221



new

Retainer - Cowl Grille;
Plastic Hole: 7 x 9 mm Oval; Head: 17.5 mm
Stem Length: 13.5 mm
Honda Accord and Odyssey '98+

Qty/Pkg 5
CAT. NO. CP998045



Clip, Weatherstrip Retainer Cowl;
Black Plastic; Fits 6 mm Hole;
Head: 8 mm x 17.8 mm
Honda Civic '93+, CRV '97+

Qty/Pkg 25
CAT. NO. CP957494



Retainer - Cowl Top
Black Plastic; Head Dia. 14 mm;
Honda Accord '90+

Qty/Pkg 15
CAT. NO. CP916939



Cowl Retainer Rivet - Screw Type;
Plastic; Hole Size: 6 mm
Grip Range 5-7 mm; Washer Face: 17.5 mm
Honda Accord '86 -'89 and Acura Vigor '92+

Qty/Pkg 25
CAT. NO. CP906749



Rivet-Screw Type; Cowl Grille;
Hole: 7 mm
Length: 11 mm; Washer Head: 14 mm
Honda Accord '90 -'91 Mazda

Qty/Pkg 25
CAT. NO. CP957463



Clip, Cowl Top; Black Plastic
Honda Accord '87+

Qty/Pkg 25
CAT. NO. CP896672



Clip, Cowl Grille and Headliner;
Gray Plastic;
Hole: 5 mm; Head: 12 mm;
Panel Range: 5 mm
Honda Accord '86+

Qty/Pkg 25
CAT. NO. CP896714

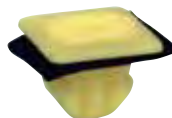

Roof Drip Rail
Grommet Nut with Sealer;
Yellow Plastic; 4 mm Screw;
10 mm x 7 mm Hole
Honda Accord '90+

Qty/Pkg 15
CAT. NO. CP916993



Cowl Screen Screw Cover;
Black Plastic
Honda Civic '84+

Qty/Pkg 15
CAT. NO. CP886431



CRL Honda/Nissan/European Cowl Fasteners



Pin, Retainer; Plastic
Vent Cowl and Interior Trim Panels
(Use with CP876210 Clip)
Honda Civic '84+

Qty/Pkg 25
CAT. NO. CP876209



Clip, Retainer; Plastic
Vent Cowl and Interior Trim Panels
(Use with CP876209 Pin)
Honda Civic '84+

Qty/Pkg 10
CAT. NO. CP876210



Cowl Vent Rivet - Screw Type;
Black Plastic
Fender Splash Shield and Air Ducts
Hole: 8 mm; Grip Range: 2 - 5 mm;
Washer Face: 20 mm;
Honda, Mazda, Nissan '84+

Qty/Pkg 10
CAT. NO. CP876211



Rivet - Screw Type; Plastic
Hole: 6 mm; Panel Range: 2 - 5 mm
Washer Face: 20 mm
Nissan, Isuzu, Mazda, Various Applications

Qty/Pkg 25
CAT. NO. CP855981



Rivet - Screw Type, Air Scoop Grill
(Cowl Vent Panel); Black Plastic
Hole: 6 mm; 2 - 6 mm Panel Range;
18 mm Washer Face
Honda Prelude '83+

Qty/Pkg 25
CAT. NO. CP866084



Rivet - Drive Type, Cowl Grille
Hole: 8 mm; 14 mm Length
20 mm Washer Head
Honda Accord '90+, Nissan Truck '87+
Mercury Villager, Maxima '98+

Qty/Pkg 15
CAT. NO. CP957462



Retainer - Cowl Grille
Black Plastic; Hole: 5 mm
Head Dia.: 12 mm; 15 mm O/L
Nissan 240SX '90+

Qty/Pkg 25
CAT. NO. CP916954



Grommet, Cowl Grille
White Plastic with Sealer
(Use with CP927012)
Nissan Maxima '90+

Qty/Pkg 15
CAT. NO. CP916949



Clip, Cowl Screen: Black Plastic
(Use with CP916949)
Head Dia.: 10 mm; O/L 18 mm
Nissan Maxima '90+

Qty/Pkg 25
CAT. NO. CP927012



Rivet - Screw Type Cowl Grille
Black Plastic
6 mm Sq. Hole; 8 mm x 12 mm Head
Grip Range 5 mm - 7 mm
Nissan 300ZX '90+

Qty/Pkg 25
CAT. NO. CP916952



Drive Rivet, Cowl Grille Retainer
Black Plastic
5mm Sq. Hole; Panel Range: 1 - 4 mm
Rectangular Face 8 x 12 mm
Nissan Pickup Truck '86+

Qty/Pkg 25
CAT. NO. CP876197



Rivet Cowl Panel to Reinforcement Plate
Hole: 6 mm; Panel Range: 2 - 8 mm
Washer Face: 14 mm
Datsun Truck '80+
Infiniti '91+

Qty/Pkg 25
CAT. NO. CP835741



Air Intake Cowl Grille
Rivet - Drive Type; Plastic Hole: 4 mm
Panel Range: 6 mm; Flange 9 mm
Mercedes, Volvo

Qty/Pkg 25
CAT. NO. CP896633



Rivet - Drive Type Cowl Vent, Plastic
Hole: 6 mm; Head: 10 x 12 mm;
Panel Range: 3.5 mm
BMW 5 and 7 Series

Qty/Pkg 25
CAT. NO. CP987865

new



General Purpose
Interior Trim Clip; Black Plastic
Hole: 7 mm
Various Ford Models

Qty/Pkg 50
CAT. NO. CP855947

CRL Ford/Chrysler Door Trim Panel Fasteners



Door Trim Panel Fastener, Bottom
Ford, Lincoln, Mercury,
All Chrysler Products

Qty/Pkg 100
CAT. NO. WC2038



Door Trim Panel Clip
Ford and Chrysler '67 - '68

Qty/Pkg 100
CAT. NO. CP673100



Door Trim Panel Clip
Ford '68+

Qty/Pkg 100
CAT. NO. CP723591



Door Trim Panel Clip with
Anti-Rattle Wedge
Ford '75+

Qty/Pkg 100
CAT. NO. CP764297



Trim Panel Clip
General Purpose

Qty/Pkg 100
CAT. NO. CP723666



Door Trim Panel Clip
Ford '81+

Qty/Pkg 25
CAT. NO. CP825590



Door Trim Panel Clip: Black Plastic
Hole: 5/16"; Panel Thickness: 3/32"
1/16" to 9/16" Grip Range
Ford, Various Models '88+
Dodge Trucks '96+

Qty/Pkg 50
CAT. NO. CP886502



Door and Interior Trim Panel Clip
Ford '75+, Chrysler '81+

Qty/Pkg 100
CAT. NO. CP784852



Panel Retaining Clip
Ford '78+

Qty/Pkg 50
CAT. NO. CP784804



Door Trim Panel Fastener, Nylon
(Used on Cardboard Panel)
Ford, Chrysler '72+, Valiant, Dart,
Duster, Demon, Cadillac '77+

Qty/Pkg 100
CAT. NO. CP713524



Door Trim Panel Clip
Ford '81+

Qty/Pkg 50
CAT. NO. CP805257



Inside Door Trim Panel Clip
Ford '78-1/2+

Qty/Pkg 50
CAT. NO. CP784839



Drive Rivet, Various Trim Attachments; Black Plastic
6.3 mm Hole; Panel Range 5-12 mm
Head Dia. 24 mm
Ford Products '84+
Jeep Grand Cherokee '94+

Qty/Pkg 25
CAT. NO. CP876193



Trim Attachment Rivet - Screw Type Various Interior
Black Plastic; 6.3 mm Hole;
Flange: 25 mm; Panel Range 2-12 mm
Ford Taurus/Sable 2000+

Qty/Pkg 25
CAT. NO. CP876297



Door Panel Retainer; Plastic
8.5 mm Hole, Middle Flange: 19.5 mm
Panel Range: 1.2 mm
Ford Taurus/Sable 2000+

Qty/Pkg 25
CAT. NO. CP998430

new



CRL GM Door Trim Panel Fasteners

 <p>Clip, Door Trim Panel Cadillac '77, GM '78 'C' Bodies '85+</p> <p>Qty/Pkg 100 CAT. NO. CP774629</p>	 <p>Clip, Door Trim Panel; Plastic GM Fiero 'P' Body '84+</p> <p>Qty/Pkg 25 CAT. NO. AV13992</p>	 <p>Panel Fastener; Nylon GM '71+</p> <p>Qty/Pkg 100 CAT. NO. CP703398</p>
 <p>Clip, Door Panel Retaining GM '83+, 'C' Bodies '85+, GM 'M' Vans '85+</p> <p>Qty/Pkg 25 CAT. NO. CP835617</p>	 <p>Clip, Door Trim Panel Side Rear Door, Plastic GM 'M' Vans '85+</p> <p>Qty/Pkg 50 CAT. NO. CP855956</p>	 <p>Clip, Door Trim Panel; Plastic GM Trucks '88+</p> <p>Qty/Pkg 50 CAT. NO. CP876344</p>
 <p>Retainer, Front Door Trim Panel White Plastic; Hole: 1/4" GM 'CK' Trucks '88+</p> <p>Qty/Pkg 25 CAT. NO. CP947244</p>	 <p>Retainer, Door Trim Panel White Plastic; Hole: 7 mm GM 'CK' Trucks '95+</p> <p>Qty/Pkg 25 CAT. NO. CP957379</p>	 <p>Retainer, Trim Panel; White Plastic Hole: 7 mm; Length: 27 mm GM 'CK' Trucks '93+</p> <p>Qty/Pkg 25 CAT. NO. CP957453</p>
 <p>Clip, Door Trim Panel; Black Plastic Hole: 6.5 mm; Head Dia.: 14 mm O/A Length: 23 mm GM 'S' Trucks '91+</p> <p>Qty/Pkg 50 CAT. NO. CP967512</p>	 <p>Interior Trim Retainer White Plastic; Hole: 7 mm Head Dia.: 13 mm; O/A Length: 31 mm GM '92+</p> <p>Qty/Pkg 25 CAT. NO. CP967579</p>	 <p>Door Panel Retainer; White Plastic Hole: 7 mm; O/A Length: 20 mm Head Dia.: 18 mm; Panel Range: 2 - 7 mm GM 'U' and 'W' Bodies '97+</p> <p>Qty/Pkg 50 CAT. NO. CP977621</p>
 <p>Door Panel Retainer; White Plastic Hole: 7 mm; O/A Length: 30 mm; Head Dia.: 18 mm GM 'U', 'W' and 'Y' Bodies '97+</p> <p>Qty/Pkg 50 CAT. NO. CP977622</p>	 <p>Door Trim Panel Retainer; Gray Plastic Hole: 7 mm; O/A Length: 35 mm Head Dia.: 19 mm; Stem Length: 32 mm GM 'M' Vans '94+</p> <p>Qty/Pkg 25 CAT. NO. CP977623</p>	 <p>Rear Door Trim Panel Retainer White Plastic; Hole: 7 mm O/A Length: 35 mm; Head Dia.: 13 mm Stem Length: 30 mm GM 'M' Vans '94+</p> <p>Qty/Pkg 25 CAT. NO. CP977624</p>

CRL Ford/GM Door Trim Panel Fasteners



Door Trim Panel Clip; White Plastic
Hole: 7 mm; Head Dia.: 6.2 x 11 mm
O/A Length: 27.5 mm
Lincoln Towncar '95+

Qty/Pkg 25
CAT. NO. CP967513



Door Trim Panel Clip; Upper
Yellow Plastic; Hole: 7 mm
Head: 6 x 11 mm; O/A Length: 34.5 mm
Lincoln Continental '95+

Qty/Pkg 25
CAT. NO. CP967514



Door Trim Panel Clip; Lower
Green Plastic; Hole: 7 mm;
Head: 6 x 11 mm; O/A Length: 44.5 mm
Lincoln Continental '95+

Qty/Pkg 25
CAT. NO. CP967515



Rivet; Drive Type
Interior Trim, Rear Compartment
2-6 mm Panel Range, 6 mm Hole
18 mm Head Dia.; Gray Plastic
Ford Probe, Mazda MX6

Qty/Pkg 25
CAT. NO. CP896579



Trim Panel Clip
Ford '77+

Qty/Pkg 100
CAT. NO. CP774508



Blind Rivet, Super Tough Nylon, Trim Attachments
Double Head; 6.3 mm Hole Dia.
0.5 - 3.5 mm Panel Range
16.8 mm Head Dia. and Shoulder Dia.
Ford Taurus/Sable '86+

Qty/Pkg 25
CAT. NO. CP876313



Grommet, Plastic Door Trim
4.2 mm Screw Size
Hole: 12 mm; Washer Face: 22 mm
Ford Contour and Mercury Mystique '95+

Qty/Pkg 25
CAT. NO. CP957377



Retainer, Door Trim; Black Plastic
Ford Contour and Mercury Mystique '95+

Qty/Pkg 10
CAT. NO. CP957373



Retainer, Door Trim; Black Plastic
Ford Contour and Mercury Mystique '95+

Qty/Pkg 10
CAT. NO. CP957374



Retainer, Door Panel; Yellow Plastic
Hole: 5/16"; Head Dia.: 1/2"
O/A Length: 15/16"
Ford Windstar '95+

Qty/Pkg 100
CAT. NO. CP967501



Stamped Nut M4 - .07 mm, 14 mm
14 mm Flange with Sealer; 9 mm Across the Flats
Ford Trucks, Back and Side Glass
General Usage

Qty/Pkg 50
CAT. NO. CP927026



Seat Back Clip
Camaro, Firebird, and
Chevrolet S and T Truck '82+

Qty/Pkg 25
CAT. NO. CP825543



Trim Panel Clip, Natural Plastic
GM '77+

Qty/Pkg 50
CAT. NO. CP784792



Door Trim Panel Clip
GM 'N' Body '85+

Qty/Pkg 50
CAT. NO. CP855990



Trim Panel Clip
Chevrolet and GM Pickup Trucks '77+

Qty/Pkg 100
CAT. NO. CP774622



CRL GM/Chrysler Door Trim Panel Fasteners



Clip, Door Panel; Fits 1/2" x 1/8" Slot
Panel Range .050-.125"; No. 6 Screw
Chrysler LH Models '93+

Qty/Pkg 25
CAT. NO. CP957479



Retainer Trim Panel; Rubber
(Used with CP855990 Trim Clip)
GM 'N' Body '85+

Qty/Pkg 50
CAT. NO. CP886436



Clip, Door Trim Panel
Yellow Plastic; Hole: 1/4"
Various GM Models

Qty/Pkg 50
CAT. NO. CP916897



Clip, Door and Quarter Trim Panel
White Plastic; Hole: 7 mm; O/A Length: 30 mm
GM 'W' Bodies '89+

Qty/Pkg 50
CAT. NO. CP906803



Clip, Door Trim Panel
White Plastic; Hole: 7 mm
Saturn '91+

Qty/Pkg 50
CAT. NO. CP927043



Retainer, Trim Panels; Black Plastic
Hole: 7.9 mm; Head: 19 mm; Stem Length: 23 mm;
GM Saturn '91+, Chrysler Mini Vans '87+
GM C/K Trucks '99+

Qty/Pkg 25
CAT. NO. CP957393



Retainer, Front Door Trim
White Plastic; Hole: 8 mm
Honda Accord '90+

Qty/Pkg 25
CAT. NO. CP957383



Door Trim Clip; Yellow Plastic
Hole: 7.5 mm; O/A Length: 32.5 mm
Mid Head Dia.: 16 mm
Chrysler Sebring '96, Jeep Cherokee '93+

Qty/Pkg 25
CAT. NO. CP967547



Retainer, Door Trim Panel
White Plastic; Hole: 9 mm
Chrysler Laser '89+; Stealth '91
Jeep Eagle and Talon '90+
Mitsubishi Eclipse and Montero '90+

Qty/Pkg 15
CAT. NO. CP916893



Retainer, Door Panel
Black Plastic; Hole: 1/4"
Jeep Wrangler '91+, GM Vehicles
Thru '88, Navistar Trucks

Qty/Pkg 25
CAT. NO. CP937184



Retainer, Door Panel
Orange Plastic; Hole: 6.7 mm
Chrysler Neon '95+
Dodge Trucks '94+

Qty/Pkg 100
CAT. NO. CP967521



Door Trim Panel Fastener; Nylon
(Used on Plastic Panels)
Chrysler '72, Dodge and Plymouth

Qty/Pkg 100
CAT. NO. CP713525



Trim Panel and Headliner Fastener
3/16" Hole; 3/4" Head;
Panel Range 3/32" - 13/32"
'84-'88 Chrysler/AMC

Qty/Pkg 50
CAT. NO. CP987807



Clip, Door Trim Panel; Plastic
Ford, Jeep, Eagle Premier '88+

Qty/Pkg 50
CAT. NO. CP886465



Retainer, Door Panel and Interior Panel
Various Chrysler '86+

Qty/Pkg 15
CAT. NO. AV12134

CRL Chrysler/Import Door Trim Panel Fasteners



Clip, Door Trim Panel
Trim Panel Thickness: Up to 5/64"
Hole Size: 9/16"
Chrysler Products

Qty/Pkg 50
CAT. NO. CP947358



Drive Rivet, Interior Trim; Plastic
Chrysler Passenger Cars and Vans '83+

Qty/Pkg 25
CAT. NO. CP835671



new

Retainer - Door Panel; Plastic
Hole: 7 mm; Stem Length: 15 mm
Panel Range: 1.7 - 2.25 mm
Jeep Grand Cherokee '99+

Qty/Pkg 25
CAT. NO. CP997917



new

Clip - Door Trim Panel; Yellow Plastic
Hole: 7 mm; Stem Length: 14 mm
Panel Thickness: 1 mm
Chrysler Mini Vans '97+

Qty/Pkg 50
CAT. NO. CP987776



new

Retainer - Door Panel; Plastic
Hole: 9 mm; Stem Length: 14 mm
Panel Range: .80 - 1.50 mm
Chrysler Mini Vans '97+, Ford Escape 2001+

Qty/Pkg 25
CAT. NO. CP987784



new

Clip - Door Trim Panel; Green Plastic
Hole: 7 mm; Stem Length: 15 mm
Panel Thickness: 2 mm
Chrysler Mini Vans, Cirrus,
Stratus and Breeze '95+

Qty/Pkg 50
CAT. NO. CP987775



new

Retainer - Door Panel
Plastic with Seal; Hole: 9.5 mm
Flange: 22 mm; Panel Range: .66 - 1.91 mm
Chrysler Neon 2000+

Qty/Pkg 10
CAT. NO. CP998066



new

Retainer - Door and Tail Gate Trim; Plastic
Hole: 8 mm; Stem Length: 18 mm
Panel Range: .8 - 1.5 mm
Chrysler Mini Vans and Dodge Durango '98+

Qty/Pkg 15
CAT. NO. CP998092



new

Pin - Door Panel Retainer; Plastic
Upper Head: 13 mm; Lower Head: 23 mm
O/A Length: 25 mm
Chrysler LH 2000+

Qty/Pkg 25
CAT. NO. CP998093



Clip, Trim Panel
GM Nova '85+, Toyota

Qty/Pkg 25
CAT. NO. CP815415



Clip, Trim Panel
Honda

Qty/Pkg 25
CAT. NO. CP815389



Clip, Trim Panel
Datsun

Qty/Pkg 25
CAT. NO. CP815416



Trim Panel Rivet; Black Plastic
Datsun

Qty/Pkg 100
CAT. NO. CP764361



Trim Pad Fastener; Black Plastic
Volvo

Qty/Pkg 50
CAT. NO. CP714008



new

Retainer - Door Panel and Interior Trim; Plastic
Hole: 8 mm; Stem Length: 12 mm
Panel Range: 0.7 - 2.0 mm
Volvo C70, S70, V70, '98+

Qty/Pkg 25
CAT. NO. CP998166



CRL Trim Fastener Release Tools

CRL Clip-Zip Tool

- Squeezes Trim Fasteners Out
- Helps Prevent Panel Fasteners from Tearing Interior Panels



CAT. NO. CZ326

The CRL Clip-Zip Tool makes the frustrating job of trim fastener removal simple. Slide the fork under the fastener head and squeeze the handles. Fastener pops out without damage to panel or trim molding. Use to remove hood insulation, door trim, wire harnesses, headliner fasteners and more. Made of high carbon steel and heat treated for strength. Zinc coated for corrosion protection. The more you use it, the more uses you'll find for it.

CRL 10-in-1 Universal Trim Tool

- 10 Tools in One Handy, Easy to Use Tool



CAT. NO. 21510T

The 10-in-1 Universal Trim Tool is a must for every auto glass installer. This handy tool does many of the jobs you normally have to do with a variety of other more expensive tools. It's made of tempered spring steel and is comfortable to hold. Why pay for an assortment of specialty tools, and then try to keep track of them, when the 10-in-1 Universal Trim Tool will do it all?

CRL Door Panel Removal Tool

- Removes Plastic Door Panel Fasteners Without Breakage



CAT. NO. L35400

The CRL Door Panel Removal Tool makes access to the door glass easier. Place the tool under the edge of the door panel, insert tool under the fastener as far as possible, and then simply pry up. Rugged tool with a large comfortable handle. Care must be used during the removal to not dimple the exposed metal of the door.

CRL Door Panel Release Tool

- Won't Break Fastener
- Can Be Used on Ford, GM, and Chrysler

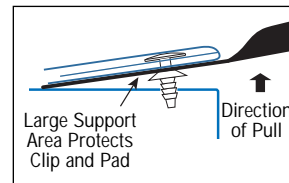

CAT. NO. 21700

The CRL Door Panel Release Tool is designed especially for removing plastic trim pad fasteners by reaching under the trim panel. It supports and grips the fastener, and removes it without breakage or scratched paint. Made of heat-treated steel, with beveled edges for each access to fasteners.

CRL Plastic Fastener Removal Tool

- For Plastic Door Panel Fasteners
- Sliding Button for Extra Leverage



new



CAT. NO. L35260

The CRL Plastic Fastener Removal Tool quickly removes various types of plastic fasteners. The tool is equipped with a sliding urethane button for use when extra leverage is required.

CRL 5-Piece Door Panel Removal Set

- Stainless Steel Blades
- Soft Ergonomic Handles

new



CAT. NO. DT6200

Add this kit to your tool box and be prepared for just about any door panel on the market. This complete set will provide you with the majority of tools required for this function. The stainless steel blades will offer years of use, and the soft ergonomic grips are comfortable to hold. From cowl vent push rivets to large door panel fasteners, this kit will remove them all.

CRL 2-Piece Long Reach Door Panel Removal Kit

- Stout 3/8" Steel Shafts Make it Possible to Get at Hard to Reach Fasteners

new

Door panels always had the fasteners on the outside edges for easy access, but nowadays you can sometimes find them right in the middle of the door. This makes it difficult to pull free without worrying about buckling the panel or breaking the fastener. We offer our Long Reach Door Panel Removal Tool Kit with one each 20" (508 mm) and 10" (254 mm) long tool for those hard to reach fasteners. Both have 3/8" (10 mm) steel shafts for prying strength.



CAT. NO. V6132

CRL 24" Flexible Shaft Magnetic Pick-Up Tool

- Sheath Prevents Magnet from Adhering
- Fingertip Controller Exposes Magnet

new



CAT. NO. 13FM



Our 24" Flexible Magnetic Pick-Up Tool remains inactive until you depress the Fingertip Controller to expose the magnet. This prevents the magnet from becoming stuck to every metallic item around while trying to fish out that lost screw or bolt. The flexible shaft allows you to reach between and around areas not accessible to straight magnetic pick-up tools.

CRL 24" Flexible Shaft Four-Finger Claw Pick-Up Tool

- Excellent for Non-Magnetic Items
- Flexible Shaft Allows Easy Access

new



CAT. NO. 24FC

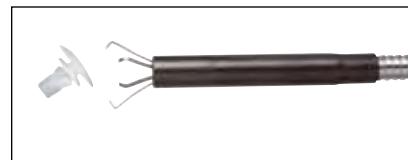

If you drop a non-metallic part inside a door it can be a real problem, but we have the solution with our Flexible Shaft 4-Finger Claw Pick-Up Tool. This tool operates the same as our Magnetic Pick-Up Tool with an easy-to-use Finger Controller. Pick up the part and be prepared for any dropped item, metallic or not.

CRL Folding Work Seat

- Heavy Canvas Seat and Tubular Legs
- Folds for Easy Storage
- Adjustable Carrying Strap

This handy CRL Folding Work Seat is designed to go anywhere you need a seat, and is just the right height for working on door glass. Fold it up and put it in your tool chest or behind the seat of your truck. The seat stands 16" (40.6 cm) high assembled, and comes with a convenient carrying strap.



CAT. NO. CRL197



CRL Headliner Tools

- Stuffs Headliners into Locking Channels
- Also Great for Landau Tops
- Three Models to Choose From

These CRL Headliner Tools are ideal for stuffing headlining in channels above car doors or upholstery trim edges into hard-to-get-at places. Edges won't damage material, and work easily around corners. HT501 Tool also releases headliner clips. There are three models to choose from.



CAT. NO. CP254

This tool has a spring steel blade riveted in a wood handle. Blade width is 1-1/2" (38 mm). Overall length is 7" (178 mm).



CAT. NO. CP126

This all steel tool has rounded edges that won't damage headliner materials. Overall length is 5-3/4" (146 mm).



CAT. NO. HT501

Durable tempered stainless steel tool removes double or single prong headliner clips without breakage. Features tough vinyl grip. Overall length is 6-1/4" (159 mm).

CRL Door Handle and Window Crank Spring Tool

- Makes Clip Removal Easy



CAT. NO. CP26

The most widely used tool for removal of inside handles is our CRL Door Handle and Window Crank Spring Tool. Fits GM, Ford, and most American Motors products 1962-74. Spring remains on handle. Use reverse end of tool to remove door panels.

CRL Windshield Molding and Door Clip Release Tool

- GM and Ford Models
- Prevents Molding Damage



CAT. NO. L35200

This CRL Door Clip and Windshield Molding Release Tool releases clips on chrome windshield moldings. The offset handle allows for easy access. This tool also works on spring retention clips on door handles. Slips under door handle without damage to the door panel material.

CRL Door Glass Window Holders

new

- Holds Glass Up While You Work Inside the Door



CAT. NO. WH745

Our Door Glass Window Holders are a simple to use tool that will hold side door glass up while you work inside the door. Press cups up against one side of glass, loop over door frame and apply cups to other side. Fast and simple to install or remove. Two per set.

CRL Window Roller Nut Removal Tool

- Fits 1/4" Drive Ratchet Wrench
- Steel Dowel Pins
- 1/2" Depth



CAT. NO. CRL830

The CRL Window Roller Nut Removal Tool fits window regulator roller nuts used on Chrysler, General Motors, Ford, and American Motors cars. The tool will hold nut in position for removing and replacing in blind operations. It is designed to work on any 1/4" drive ratchet wrench.

CRL MultiSpanner

- Fits 95% of All Door Glass Retainers
- Uses 1/4" Drive Ratchet Wrench



CAT. NO. DZ623

Our CRL MultiSpanner fits up to 95% of all the door glass retainer nuts on the market. Made of steel with tempered steel pins, this tool will outlast all others you may have. Use your 1/4" drive ratchet wrench to make short work out of a difficult job.

CRL GM and Chrysler Roller Nut Wrench

- Removes Door Glass Nuts Easily



CAT. NO. CP673115

The CRL Roller Nut Removal Tool removes GM and Chrysler door glass retainer nuts quickly. The low profile makes it easier to use in tight places.

CRL Saturn Roller Nut Wrench

- Removes Saturn
Door Glass Nuts Easily



CAT. NO. CP937174

This CRL Roller Nut Removal Tool has a low profile design to make it easier to remove door glass retainer nuts from 1991+ Saturn vehicles.

CRL Upholstery Nail Remover

- Extra Long Prongs to Ease Removal of
Inside Panels
- Gently Prys without Damage



CAT. NO. CP255

The CRL Door Panel Remover gently prys door panels off quickly and easily. Its heavy-duty shaft and prongs are durable and easy to use.

CRL Door Upholstery Remover

- Removes and Saves All Types of Clips



new

CAT. NO. SCR696

Our Door Upholstery Remover Tool removes all types of clips without damaging them, so you can save them for re-installation. It's terrific for removing door panels. Many clips fit tightly into the hole, against the vehicle surface. The front of this tool is tapered so it will easily fit under a clip. Spread the jaws slightly so they go around and under the clip. Next, close the jaws and the tool will remove the clip without damaging it.

CRL Universal Door Glass Aluminum Brackets

- Universal Brackets for Use in Various Import and Domestic Vehicles



CAT. NO. AGB1

These CRL Universal Door Glass Brackets are made from extruded aluminum with 1/4" - 20 securing bolts and nuts. Nylon securing screw quickly fastens the brackets to the glass. Sold only by the pair.

CRL Universal Door Glass Plastic Brackets

- Fit Various Domestic and Imported Vehicles

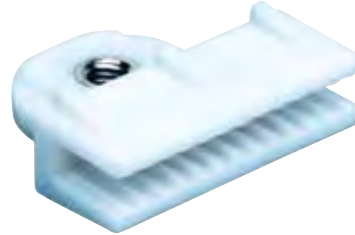

Qty/Pkg 5
CAT. NO. CP937102

Door window bracket, plastic w/M6-1.0 threaded steel insert. Can be used on various import and domestic vehicles.

CRL Plastic Window Washer Holder/Separator

- Holds Plastic Washer While Drilling
- Separates Washers



CAT. NO. CST522

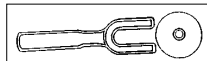

Use to Hold While Drilling

This CRL Plastic Window Washer Holder/Separator works to solve two problems. Rivets often spin while being drilled out. The CRL Plastic Window Washer Holder prevents this from occurring. Wedge this tool in the plastic washer to hold it while drilling out the rivet. Then insert the tool between the plastic washers to separate them without breaking. Injected molded plastic will provide years of service life.

CRL Latch Pin Removal Pliers

- Removes and Replaces Split Pins in Swing Out Window and Sunroof Latches
- Make a Tough Job Easy



CAT. NO. PRT305

CRL Latch Pin Removal Pliers have five adjustable settings that will fit any "swing out" window or sunroof latch. This tool not only removes these difficult to remove pins, but can also be used to reinstall them.

CRL No-Krak Channel Driver

- Safely Drives Channel Onto Glass
- Prevents Channel from Spreading



CAT. NO. 57

The CRL No-Krak Channel Driver is forged from special tool steel. It's machined grooves and offset head enables you to get under the flange when tapping the channel onto the glass. Using the CRL No-Krak Channel Driver helps to prevent spreading the sides of the channel, resulting in a wedging action against the rollers.

CRL Fiber Driving Wedge

- Can Be Used to Drive Glass On or Off of Channel



CAT. NO. F102

The CRL Fiber Driving Wedge is a great multi-purpose driving wedge primarily used for removing framework and channels from a piece of glass. Ideal for knocking door glass from the lower channel. Made of a tough, rigid fiber material.

CRL Combination Rivet Tool

- Removes and Resets Rivets
- Repairs Wing Window Without Removal

You can use this CRL Combination Rivet Tool to replace and set rivets in lower vent pivots, vent handle brackets, and some division bars in many older cars. You can also replace vent handle brackets without removing the vent from the car. One side of the tool is for removing old rivets, and the other for setting new rivets. The rivets are rolled, not flattened, so it is quick and easy to operate. Comes complete with RT1200A Remover Screw and RT1200B Small Rivet Setting Screw. For larger rivets use Cat. No. RT1200C, which must be ordered separately. If you need a spare Allen Wrench order Cat. No. RT1200D separately.



CAT. NO. RT1200

Rivet Remover Screw



CAT. NO. RT1200A

Setting Screw for Small Rivets



CAT. NO. RT1200B

Setting Screw for Large Rivets



CAT. NO. RT1200C

CRL Rivet Stem Removal Tool

- Makes Drilling Out Door Glass Rivets Easier
- Spring Loaded Hardened Steel Tip



new

CAT. NO. RSR1

Removing door glass without breaking it usually requires you drill out the rivets. The first step in doing this involves removing the rivet's stem, typically a difficult task. Using the CRL Rivet Stem Removal Tool to force the stem out makes this a much easier job.

The concave end of the tool self-centers on the rivet to perfectly align the spring loaded hardened steel tip with the rivet stem. A few light taps with a hammer on the handle end of the tool will drive the rivet stem out.

CRL Channel Chisel

- Removes Broken Glass and Adhesive from Channel
- Heavy-Duty Steel



CAT. NO. 476

The CRL Channel Chisel is made of the best tool steel available, and set at the proper angle to easily remove broken pieces of glass from channels. This tool is 16" (41 cm) long.

CRL Door Glass Channel Cleaning Tool

- Cleans Broken Glass from Channel
- Extra Length Reaches Complete Channel without Removing Panel



CAT. NO. GCC506

The extra long 24" reach of the CRL Door Glass Channel Cleaning Tool lets you get down into the door glass run channel to clean out broken bits and pieces of tempered glass. The hook shaped tip gets under channel lip and other places you can't normally reach and removes them without damage to the channel.

CRL Channel and Vent Tool

- Cleans Broken Glass and Adhesive from Channel
- Heavy Duty Steel Blade and Plastic Handle



CAT. NO. CP214

The CRL Channel and Vent Tool is excellent for use as a regular channel chisel, and is also very handy for removing glass from vent frames. The overall length of the tool is 12-3/4" (32.4 cm).



CRL WeatherGuard™ Temporary Window

- Protect the Interior of Your Customer's Vehicles When a Window Can't Be Replaced Immediately
- Lasts Up to One Week

At last, a professional approach to a safe and attractive way of providing a temporary window when needed. A broken window is a hazard as well as an inconvenience, and cannot always be replaced immediately. WeatherGuard™ is a solution to that problem.

The CRL WeatherGuard™ Temporary Window is a sturdy, flexible clear plastic sheet with an adhesive perimeter that can be applied to the outside of the door. WeatherGuard™ can be left on the vehicle for up to one week while you wait for the replacement glass to make a permanent repair.

To accommodate most all application requirements WeatherGuard™ is available in two sizes, and can be cut to fit vent windows and other odd shapes. Use two of them together for back lites. Packed five per sleeve, they can be shipped economically via U.P.S.

NOTE: This product is not recommended for use on poorly repainted surfaces. Purchasers shall be solely responsible for determining the adequacy of the product for any and all uses to which the purchaser shall apply the product, and the application of the product by purchaser shall not be subject to any implied warranties of fitness for that purpose.

CAT. NO.	MAXIMUM REPAIR SIZE	QTY/SLEEVE
TW2632	26" by 32" (66 cm by 81 cm)	5
TW2642	26" by 42" (66 cm by 106 cm)	5

Minimum order is five of one size. Must be ordered in increments of five.

It's the Best Temporary Solution!



A shattered window leaves the interior of the vehicle exposed to the elements.



WeatherGuard™ protects the interior of the vehicle – and your reputation!

CRL Side Window Vise

- Designed to Make Repairing Door Glass Mechanisms Easier
- Holds Glass Up While You Work Inside Door



CAT. NO. RE142

The CRL Side Window Vise holds the side door glass up while you make repairs inside the door. Simply press the suction cups against one side of the glass while it is in the raised position, then loop other end over the door and apply suction cups on the other side. Large double cups assure positive suction, with no slippage or damage to window tint. Fast and easy to apply and remove.



CRL Power Window Bypass Kit

- Works on Any Domestic or Imported Vehicle to Operate the Power Windows without the Ignition Key



CAT. NO. WBK662

The CRL Power Window Bypass Kit helps auto glass technicians replace powered door glass in vehicles. It includes a safety feature on "express down" windows that are becoming more widespread on current production automobiles. It plugs into the cigarette lighter and temporarily taps into the motor wires allowing for operation of power windows without the key, eliminating battery drain. Includes quick attaching clips that require no splicing of vehicle wiring.

CRL GM Window Guides

Typical Window Guide Installation

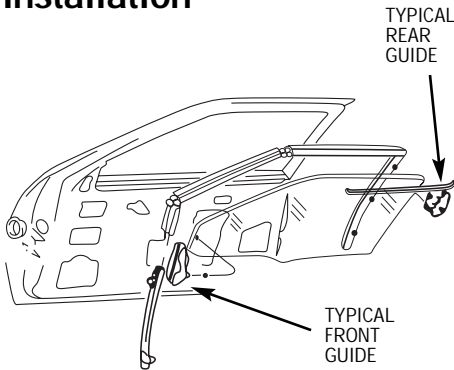

The illustration above shows placement of front and rear guides. Components are added continually for newer model cars. If the part you require is not shown go to crlaurence.com.



Front Door Glass Guide; Plastic
GM 'J' Bodies '82+

Qty/Pkg 25
CAT. NO. CP855976



Rear Door Window Guide;
GM '80+ Wagons
'B', 'C'
and 'X' Bodies

Qty/Pkg 25
CAT. NO. CP805162



Front Door Window Guide;
GM '80+ Buick, Cadillac, and Olds
'B', 'C', and 'X' Bodies,
'S' Trucks '82-'90, 'A' Bodies '82-'86

Qty/Pkg 25
CAT. NO. CP805161



Rear Door Window Guide; Plastic
GM 'J' Bodies '82+

Qty/Pkg 25
CAT. NO. CP855886



Rear Door Window Guide; Plastic
GM 'C' Bodies '82+

Qty/Pkg 25
CAT. NO. CP855887



Front Door Window Guide; Plastic
GM, Olds, and Buick 'N' Bodies '85+
U-Van '90 -'96

Qty/Pkg 25
CAT. NO. CP855891



Front Door Window Guide; Plastic
GM, Olds, and Buick 'C' and 'N'
Bodies '85+, U-Van 90+

Qty/Pkg 25
CAT. NO. CP855920



Front Door Window Regulator
Guide, Right Side; Plastic
GM, Olds, and Buick
'C' and 'N' Bodies '85+

Qty/Pkg. 2
CAT. NO. CP977666



Front Door Window Regulator
Guide, Left Side; Plastic
GM, Olds, and Buick
'C' and 'N' Bodies '85+

Qty/Pkg 2
CAT. NO. CP977667

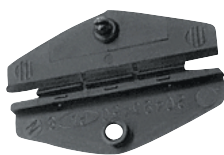

Upper Rear Door
Window Guide; Plastic
Chevrolet Corsica '87+

Qty/Pkg 25
CAT. NO. CP886452

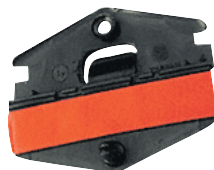

Front Door Window Guide with
Adhesive Gasket; Plastic
GM 'A' Bodies '87+
'S' Trucks '88+

Qty/Pkg 10
CAT. NO. CP896594



Front Door Window Guide; Plastic
GM 'C' and 'H' Bodies '85 - '93

Qty/Pkg 25
CAT. NO. CP896648



CRL GM/Chrysler Window Guides

 <p>Front Door Window Guide (Rear); Plastic GM 'C' and 'H' Bodies '85+</p> <p>Qty/Pkg 25 CAT. NO. CP876294</p>	 <p>Front Door Window Guide; Plastic GM 'J' Bodies '82+</p> <p>Qty/Pkg 25 CAT. NO. CP876295</p>	 <p>Front Door Window Guide; Plastic GM 'A' Bodies '90+</p> <p>Qty/Pkg 10 CAT. NO. CP998031</p>
 <p>Rear Side Door Window Guide; Plastic GM S10 Blazer 4 Door</p> <p>Qty/Pkg 15 CAT. NO. CP927002</p>	 <p>Front Door Window Guide (Rear); Plastic GM 'J' Bodies '82+</p> <p>Qty/Pkg 25 CAT. NO. CP947300</p>	 <p>Front Door Window Regulator Guide - No Stud; Plastic GM '85+</p> <p>Qty/Pkg 5 CAT. NO. CP947307</p>
 <p>Front Door Window Guide; Plastic GM 'S' Series Truck '91+</p> <p>Qty/Pkg 15 CAT. NO. CP947231</p>	 <p>Front Door Window Guide (Rear); Plastic GM Corsica '87+</p> <p>Qty/Pkg 15 CAT. NO. CP947232</p>	 <p>Door Glass Guide; Plastic GM 'U' Vans '97+</p> <p>Qty/Pkg 10 CAT. NO. CP987883</p>
 <p>Door Glass Guide with Rivets; Plastic Chrysler LeBaron, GTS, Dodge Lancer, Sundance, Shadow, Acclaim, Spirit '89+</p> <p>Qty/Pkg 25 CAT. NO. CP866056</p>	 <p>Door Glass Guide; Plastic Dodge Dakota Pickup '87+</p> <p>Qty/Pkg 15 CAT. NO. CP876361</p>	 <p>Front and Rear Door Window Guide; Plastic Saturn 96+</p> <p>Qty/Pkg 5 CAT. NO. CP967597</p>

CRL Window Guide Pliers

• Lets You Reuse Hard to Replace Window Guides

There are many different window guides on today's cars, but you never seem to have the right one to replace the one you just removed. These CRL Window Guide Pliers were developed by an auto glass technician to save the old window guide and assist in putting it back on the new glass. The jaws are made so they will go around the window guide without damaging it, and exert the pressure on the part that snaps together. The handle is made with a slotted area that can be used to pry the plastic snap loose so you can reuse the guide. Saves you both time and money.

CAT. NO. JP685

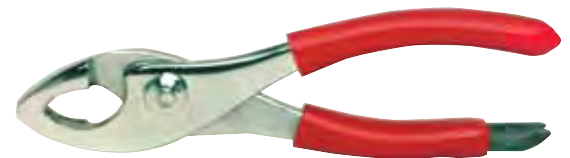

CRL WINDOW REGULATORS/MOTORS

For Pricing on CRL Products, Call Toll Free (800) 421-6144, or Visit crlaurence.com

Sometimes you just can't fix a customer's door regulator or motor, so you have to hunt for a replacement. Finding that replacement can take all day if you don't call the dealership first and then wait for it to come in.

To reduce this down time, CRL now offers a selection of many commonly requested power regulators and motors. These quality regulators and motors will have your customer's window back to "like new" condition in no time.

new

CRL Regulator Motor

- 1982 – 2002
Most GM Cars



CAT. NO.	APPLICATION
WMGM82C	All Windows

CRL Regulator Motor

- 1995 – 1999
Ford Windstar

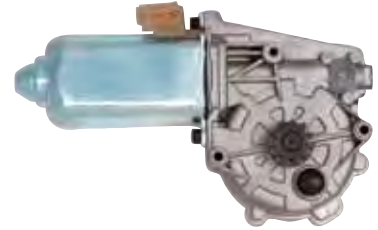

CAT. NO.	APPLICATION
WMW1N95L	Driver's Side
WMW1N95R	Passenger's Side

CRL Front Door Regulator with Motor

- 1992 – 1996
Toyota Camry
4-Door

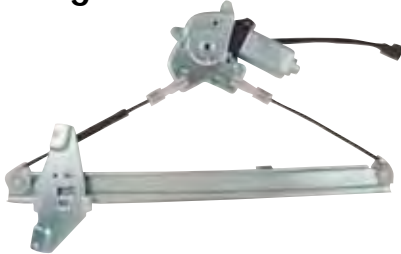

CAT. NO.	APPLICATION
WRCA92LF	Driver's Side
WRCA92RF	Passenger's Side

CRL Rear Door Regulator with Motor

- 1992 – 1996
Toyota Camry
4-Door



CAT. NO.	APPLICATION
WRCA92LR	Driver's Side
WRCA92RR	Passenger's Side

CRL Front Door Regulator with Motor

- 1993 – 1997
Toyota Corolla
4-Door



CAT. NO.	APPLICATION
WRC093LF	Driver's Side
WRC093RF	Passenger's Side

CRL Front Door Regulator with Motor

- 1990 – 1993
Honda Accord
4-Door

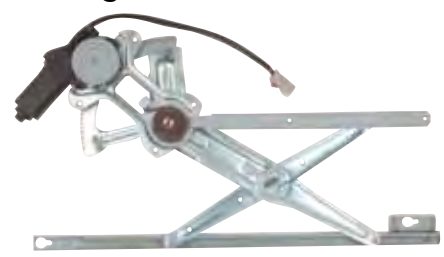

CAT. NO.	APPLICATION
WRAC90LF	Driver's Side
WRAC90RF	Passenger's Side

CRL Front Door Regulator with Motor

- 1994 – 1997
Honda Accord
4-Door

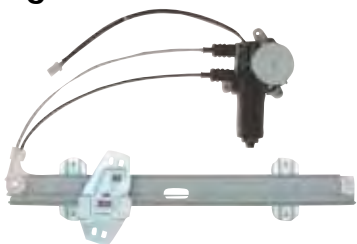

CAT. NO.	APPLICATION
WRAC94LF	Driver's Side
WRAC94RF	Passenger's Side

CRL Front Door Regulator with Motor

- 1994 – 1997
Honda Accord
2-Door

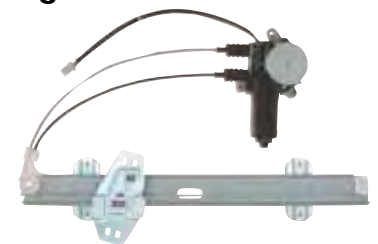

CAT. NO.	APPLICATION
WRAC94LM2	Driver's Side
WRAC94RM2	Passenger's Side



LOG ON TO crlaurence.com FOR BUSINESS-TO-BUSINESS SERVICES

A282 | PHONE (800) 421-6144 | FAX (800) 262-3299 TOLL FREE FROM ANYWHERE IN THE U.S.A. OR CANADA

CRL WINDOW REGULATORS/MOTORS

For Pricing on CRL Products, Call Toll Free
(800) 421-6144, or Visit crlaurence.com

CRL Front Door Regulator with Motor

- 1993-1995
Nissan Altima



CAT. NO.	APPLICATION
WRAL93LF	Driver's Side
WRAL93RF	Passenger's Side

CRL Regulator Motor

- 1989-1994
Nissan Maxima
- 1990-1994
Nissan 300ZX



CAT. NO.	APPLICATION
WMMA89	All Doors

CRL Regulator Motor

- 1995-2000 Nissan
Maxima/Stanza/Pathfinder
- 1995-2000
Infiniti G20, J30

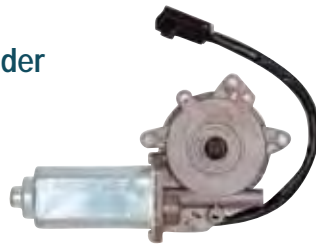

CAT. NO.	APPLICATION
WMMA95L	Driver's Side
WMMA95R	Passenger's Side

CRL Regulator Motor

- All 1982-1995
Mazdas
- All 1982-1995
Toyotas
(Except 1990 - 1995 Cressida)



CAT. NO.	APPLICATION
WMTY82	All Doors

CRL GM Window Lift Motors

- 1979 - 1996 Buick, Oldsmobile, and Pontiac
- 1979 - 1994 Cadillac and Chevrolet Models
- 1979 - 1995 GMC Light Trucks
- 12 Tooth Gear

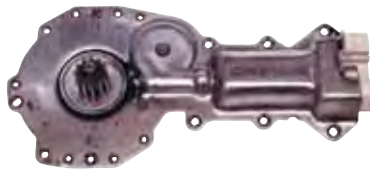

CAT. NO. CP937107

CRL Lincoln Window Lift Motors

- 1980 - 1989 Lincolns
(Various Models)
- Nine Tooth Gear

new

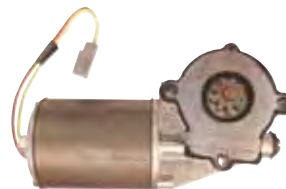

CAT. NO. CP937109

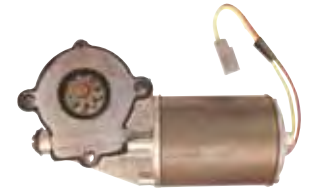

CAT. NO. CP937108

CRL Window Lift Motors for Various Ford Models

- 1980 - 1983 Fairmont
- 1980 - 1986 Grenada
- 1980 - 1989 LTD and Marquis
- 1981 - 1986 Thunderbird and Cougar
- 1984 - 1992 Lincoln Mark Series
- 1984 - 1994 Tempo and Topaz
- 1980 - 1992 F-Series Trucks
- 1981 - 1992 Bronco
- 1985 - 1986 Ranger
- 1985 - 1990 E-Series Vans
- 1986 - Nov. 1989 Aerostar

- Nine Tooth Gear



CAT. NO. CP937111



CAT. NO. CP937110

NEW MODELS

Motors and Regulators for many newer models cars and trucks can be special ordered. Contact CRL Automotive Technical Sales by e-mail techsales@crlaurence.com with the year, make, model, and door position of the motor and/or regulator you need to meet your customer's requirements.

LOG ON TO crlaurence.com FOR BUSINESS-TO-BUSINESS SERVICES

PHONE (800) 421-6144 | FAX (800) 262-3299 TOLL FREE FROM ANYWHERE IN THE U.S.A. OR CANADA | A283



CRL Window Motor Bushing Kits

CAT. NO. 6437

- Replace Worn Bushings in Power Window Motors
- Saves Cost of Replacing Entire Motor or Gear

This kit contains three high density polyethylene bushings to replace worn bushings in power window motors used in many domestic cars and trucks. It's a simple repair that saves the cost of replacing an entire motor or gear. One kit repairs one gear.

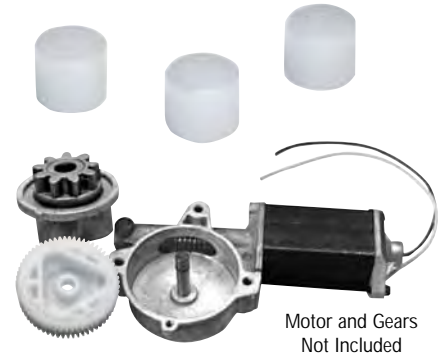

CRL Power Window Regulator Gears



Power Window Regulator Gear; Seven Teeth;
Ford Station Wagon Tailgate and Models with
Electric Vent Window Drive Gear '70+

Qty/Pkg 1
CAT. NO. CP703411



Nylon Gear for Power Window Regulator;
2-1/2" Outside Diameter;
Ford '89+

Qty/Pkg 1
CAT. NO. CP977746



Small Power Window Replacement Gear Only;
(Use with CP825509)
Various GM Makes and Models

Qty/Pkg 1
CAT. NO. CP835622



Power Window Regulator Gear; Nine Teeth;
Chrysler '64 -'75

Qty/Pkg 1
CAT. NO. CP683158



Power Window Regulator Gear; Nine Teeth;
Ford '64-'72

Qty/Pkg 1
CAT. NO. CP683157



Power Window Regulator Gear; Nine Teeth;
Chrysler '75 - '89

Qty/Pkg 1
CAT. NO. CP774628



Large Power Window Replacement Gear;
(Use with CP835622)
Various GM Makes and Models

Qty/Pkg 1
CAT. NO. CP825509



Power Window Regulator Gear; Nine Teeth;
Various American Motors Models

Qty/Pkg 1
CAT. NO. CP805284



CRL Window Regulator Parts

 <p>Window Regulator Roller Rivet; (Use with Cat. No. CP987885); GM Cars '57 -'66, Rambler '63 -'66</p> <p>Qty/Pkg 25 CAT. NO. B7717</p>	 <p>Window Regulator Roller; (Use with Cat. No. B7717); 1 1/16" Dia.; 7/32" Thick GM Cars '57 -'66, Rambler '63 -'66</p> <p>Qty/Pkg 15 CAT. NO. CP987885</p>	 <p>Window Regulator Roller and Rivet; (Same as B7717 and CP987885 Combined); 1 1/16" Dia.; 7/32" Thick GM Cars '57-'66, Suburban Rear Window, Rambler '63-'66</p> <p>Qty/Pkg 10 CAT. NO. CP987886</p>
 <p>Window Regulator Roller Rivet; (Use with Cat. No. RK137); Most GM Models Prior to '57, GM Trucks Prior to '64</p> <p>Qty/Pkg 25 CAT. NO. B7719</p>	 <p>Window Regulator Roller; (Use with Cat. No. B7719); Most GM Models Prior to '57, GM Trucks Prior to '64</p> <p>Qty/Pkg 25 CAT. NO. RK137</p>	 <p>Window Regulator Roller and Rivet; (Same as B7719 and RK137 Combined); Most GM Models Prior to '57, GM Trucks Prior to '64</p> <p>Qty/Pkg 25 CAT. NO. RK175</p>
 <p>Window Regulator Roller; 1 1/16" Dia.; 7/32" Thick General Use, Various GM Makes and Models</p> <p>Qty/Pkg 5 CAT. NO. CP987818</p>	 <p>Window Track Roller; 1" Dia.; 5/16" Thick Chrysler '73 Models</p> <p>Qty/Pkg 10 CAT. NO. CP723695</p>	 <p>Window Regulator Arm Stud Fastener; Chrysler Various Models</p> <p>Qty/Pkg 50 CAT. NO. SC3315</p>

CRL Window Regulator Drive Tape and Parts

- For GM A, B, C, and X Body Family Trucks, 1980 to Present

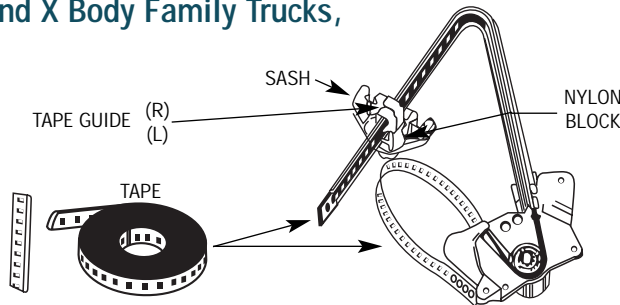

Essential Window Regulator Drive Tape and component parts for the power window regulator. The tape provides strength and flexibility over a broad temperature range.



Window Regulator Elastomeric Drive Tape provides strength and flexibility over broad temperature ranges. Comes in dispenser-type box.

Qty/Pkg 1 Roll
20' (6.09 m)
CAT. NO. CP845769

 <p>Right Hand Tape Guide CAT. NO. CP815301</p> <p>RH Guide Shown Qty/Pkg 10</p>  <p>Left Hand Tape Guide CAT. NO. CP815302</p>	 <p>Nylon Block for Tape Controlled Window Assemblies; GM '80+</p> <p>Qty/Pkg 25 CAT. NO. CP815341</p>	 <p>Flex Rack Drive Tape for Power Window Regulator Assembly; Chrysler '86+</p> <p>Qty/Pkg 1 Roll 54" (1.37 m) CAT. NO. CP896656</p>
---	--	--

CRL Window Regulator Parts



Quarter Window Regulator Roller;
15/16" Dia.; 5/16" Thick
Ford '71+

Qty/Pkg 5
CAT. NO. CP998439



Window Regulator Roller;
15/16" Dia.; 3/8" Thick
Ford '72+

Qty/Pkg 5
CAT. NO. CP998438



Window Regulator Roller;
15/16" Dia.; 5/16" Thick
Ford '72+

Qty/Pkg 10
CAT. NO. CP713552



Window Guide with Nut;
15/16" Square
Ford Cars '74+ Ford Pickups '90+

Qty/Pkg 10
CAT. NO. CP764296



Window Regulator Roller;
15/16" Dia.; 5/16" Thick
Ford '71, GM '65 and
GM J-Body '82-'91

Qty/Pkg 25
CAT. NO. CP651093



Window Regulator Roller;
Ford, Lincoln, Mercury '52-'58
Ford Truck '52-'65

Qty/Pkg 25
CAT. NO. RK100



Window Regulator Roller;
Ford, Mercury '65-'70
Edsel '59 - '65

Qty/Pkg 50
CAT. NO. RK128



Regulator Arm Stud Fastener
Ford, Lincoln, Mercury, Nash, Etc.
Chrysler Products '41-'58
Chevrolet, GMC, Tilt Cab Trucks '60-'64
International Harvester Trucks '57-'64

Qty/Pkg 50
CAT. NO. SC3314



Quarter Window Roller Guide;
15/16" Dia.; 5/16" Thick
Chevrolet and All GM Full Size Cars,
Sport Coupes '66-'67,
Convertibles '67-'68

Qty/Pkg 25
CAT. NO. CP683166



Window Regulator Roller and Pin;
21/32" Dia.; 5/32" Thick
GM '74+

Qty/Pkg 25
CAT. NO. CP784948



Door Window Roller;
15/16" Dia.; 5/16" Thick
GM '79+

Qty/Pkg 10
CAT. NO. CP795010



Front Door Window Roller;
15/16" Dia.; 5/16" Thick
GM '71 - '72 'B' & 'C' Models

Qty/Pkg 25
CAT. NO. CP713435



Window Regulator and Channel Roller;
15/16" Dia.; 5/16" Thick
GM Cars '65+, Ford Cars '71+,
GM "J" Body '82 - '91

Qty/Pkg 25
CAT. NO. CP651093



Quarter Window Channel Roller;
1" Dia.; 7/16" Thick
'67+ GM Compact and Chevelle

Qty/Pkg 5
CAT. NO. CP987820



Front and Rear Window Regulator Roller;
1" Dia.; 11/32" Thick
'69 -'74 GM Sport Coupe and Convertible

Qty/Pkg 5
CAT. NO. CP987843



CRL Window Regulator Parts



Door Glass to Channel Attaching Kit; (For Use on Thinner Glass) Ford Products '78+

Qty/Pkg 10
CAT. NO. CP795008



Door Glass Fastener Bushing; (Use with CP733842) Ford '73+

Qty/Pkg 10
CAT. NO. CP733792



Door Glass Attaching Rivet; (Use with CP733792) Ford '73+

Qty/Pkg 50
CAT. NO. CP733842



Door Glass Roller Repair Kit; Various GM Models '79-'02

Qty/Pkg 5
CAT. NO. CP998422



Door Glass Roller; Plastic (Use with CP998059); Various GM Models '79-'02

Qty/Pkg 10
CAT. NO. CP998421



Door Glass Roller Bushing Retainer; Plastic Various GM Models '82+

Qty/Pkg 15
CAT. NO. CP998059



Retainer Clip for Grooved Shaft Flex Rack Attachment to Window Motor; Chrysler '86+ General Purpose

Qty/Pkg 50
CAT. NO. CP896709



Plastic Washer for use with Nut and Bolt on Door Glass; Ford, Chrysler, GM and AMC Cars '66 - '76

Qty/Pkg 10
CAT. NO. CP998047



Door Glass Guides; Chevy Camaro and Pontiac Firebird '82+

Qty/Pkg 12 pairs
CAT. NO. CP835623



Door Glass to Regulator Plastic Nut and Bolt Assembly; Ford Contour and Mercury Mystique '95+

Qty/Pkg 2
CAT. NO. AV19281



Door Glass to Regulator Black Nylon Nut; Ford Contour and Mercury Mystique '95+

Qty/Pkg 5
CAT. NO. AV19280



Lower Channel to Glass Fastener; General Purpose GM, Ford, Chrysler Models '73+

Qty/Pkg 5
CAT. NO. CP947226

CRL Window Things



When you can't find the right Door Regulator Rivet try CRL Window Things. See page A289 for more information.

CAT. NO. WT50



Inside Door Handle, Door and Quarter Regulator Handle Retaining Clip; All GMC Models, Rambler 49+, Toyota '60 - '72

Qty/Pk 100
CAT. NO. WC2049



Window Crank Handle Retaining Clip; Various Datsun Models/Years

Qty/Pkg 50
CAT. NO. CP835723

CRL Auto Glass Rivets



Important Information About Automobile Rivets: Automotive Rivets used for regulator and door handle applications are the split rivet type. The stem is part of the structural strength of the rivet, and must remain in the rivet after application. Two important factors make this happen: Using the proper grip range rivet, and being sure to use the special automotive nosepiece in your rivet gun. The rivet stem has serrations on it that are crimped tightly at the rivet head by the special automotive nosepiece. If you use a rivet that does not fall in the proper grip range, the serrations will be below the crimping area, and when the rivet stem breaks, the stem will be propelled into the outer door panel, causing a "dimple" dent. Use caution when selecting the proper rivet for your application.

CRL Glass Stop Rivets

These rivets are used to secure the glass stop to the window glass.

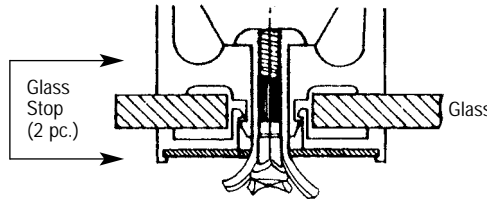

Glass Grip Range: .520" to .620"
Pack of 50 **CAT. NO. 42376** Bulk Case of 2,000 **CAT. NO. 52376**

CRL Window Regulator Rivets

These rivets are used to connect the regulator to the door or body panel.

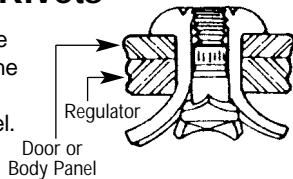

Grip Range: .032" to .140"

Pack of 50 **CAT. NO. 42371** Bulk Case of 3,000 **CAT. NO. 52371**



Grip Range: .140" to .187"

Pack of 50 **CAT. NO. 42374** Bulk Case of 2,000 **CAT. NO. 52374**

CRL Door Handle Rivets

These rivets are used to mount recessed door handles to the door panel.

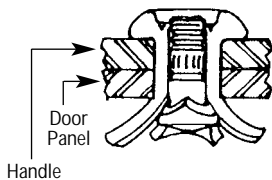

Grip Range: .090" to .115"

Pack of 50 **CAT. NO. 42372** Bulk Case of 3,000 **CAT. NO. 52372**



Grip Range: .110" to .177"

Pack of 50 **CAT. NO. 42373** Bulk Case of 2,000 **CAT. NO. 52373**

CRL Multi-Purpose Large Flange Rivet



Fits Various GM Car Trim, Accessories, etc.
Matches: GM 9432552

Qty/Pkg 50 **CAT. NO. 43314**

CRL Windshield Side Rail Rivet



Fits T-Bird and Cougar Windshield Side Rails
Matches: Ford N805759-S100

Qty/Pkg 50 **CAT. NO. CP896631**



Rivet, Peel Type, Door Window Attachment
Rivet: M6.3, Flange: 16 mm,
Grip Range: 10-16.5 mm;
Fits Lincoln Continental,
Ford Taurus and Windstar '95+

Qty/Pkg 25 **CAT. NO. CP997999**



3/32" Aluminum Rivet;
1/8" Dia. Shoulder with Steel Mandrel;
Shoulder Length 1/8", Flange Dia. 7/32";
Replaces Weld-On Stud for Attaching Stud Style Molding Clips to Panels.

CP927069 Shoulder Rivet In Set Position
Qty/Pkg 50 **CAT. NO. CP927069**



Rivet, Peel Type, Front and Rear Door Glass
Hole Dia.: 5 mm, Head Dia.: 9.8 mm,
Grip Range: 11-13 mm
Fits GM V, W, and Y Bodies '88+

Qty/Pkg 25 **CAT. NO. CP967599**



Rivet, Peel Type, Window Regulator
Rivet: 1/4", Flange: 1/2",
Grip Range: .100-.200 mm;
Ford Mustang and Lincoln Continental '94+

Qty/Pkg 25 **CAT. NO. CP987908**



CRL Auto Glass Rivets



Blind Rivet, Super Tough Nylon, Window Regulator Attachments; M5 Hole, 3-4 mm Panel Range, 9 mm Head Dia.; GM and Cadillac

Qty/Pkg 25
CAT. NO. CP876311



Blind Rivet, Super Tough Nylon, General Purpose; 4.75 mm Hole, 1.5-3.5 mm Panel Range, 9.5 mm Head Dia.; GM 'A' and 'C' Bodies, Various Ford

Qty/Pkg 25
CAT. NO. CP998058



Blind Rivet, Aluminum with Steel Mandrel (Zinc); 1/8" Rivet w/ 5/16" Flange, .125-.187 Grip Range; GM Rear Window Gasket Various Models

Qty/Pkg 50
CAT. NO. CP947237



Aluminum Rivet w/ Aluminum Mandrel for Glass Stop/Roller; 3/16" Rivet w/ 5/8" Flange, .501-.625 Grip Range; Chrysler Products, Not Supplied by O.E.M.

Qty/Pkg 25
CAT. NO. CP906792



Blind Rivet, Peel Style, for Outside Door Handle; Black Aluminum Rivet w/ Steel Mandrel; 1/4" Dia., 1/2" Flange, Grip Range .090-.115; Ford Products '88+

Qty/Pkg 25
CAT. NO. CP906793



Blind Rivet, Leg-Retention Style, for Window Sash and Door Lock Actuator; Aluminum Rivet w/ Aluminum Mandrel; 1/4" Rivet, 1/2" Flange, Grip Range .120-.400; GM 'U' Vans '90+

Qty/Pkg 15
CAT. NO. CP906794



Steel Rivet w/ Steel Zinc Mandrel; 1/4" Rivet, 1/2" Flange, .062-.125 Grip Range; GM Saturn '91+

Qty/Pkg 25
CAT. NO. CP947239



Steel Rivet w/ Steel Mandrel, Window Regulator; 1/4" Rivet, 1/2" Flange, .086-.129 Grip Range; GM 'N' Bodies '91+

Qty/Pkg 15
CAT. NO. CP947240



Steel Rivet w/ Steel Mandrel, Window Channel; 1/4" Rivet, 3/4" Flange, .060-.083 Grip Range; GM 'E' Bodies and Cadillac 'C' Body '93+

Qty/Pkg 15
CAT. NO. CP947241



Blind Rivet, Nylon, Door Weatherstrip Retainer; M4 Hole, Panel Range 2.5-5.5 mm, 15 mm x 8 mm Rectangle Head; Saturn '91+

Qty/Pkg 50
CAT. NO. CP927041



Upper Vent Pivot Shoulder Rivet; Chevrolet, Pontiac, Olds '49-'54

Qty/Pkg 100
CAT. NO. B7402

Rivet Tools



Having the right rivet is only half the solution. Install them properly with our selection of Automotive Rivet Tools. See Page A292.

CRL Window Things

- Eliminates the Need for Door Regulator Rivets in Most Vehicles
- Installs with a Phillips Screwdriver



CAT. NO. WT50

Window Things come 50 to a package, along with 50 screws and 12 washers for installations where a spacer is required.

Install door glass the easy way with CRL Window Things. This handy item will virtually eliminate the need for most auto glass rivets now in use. Window Things fit Ford, GM, and Chrysler products, and replace traditional snap-through or screw type retainers. Simply snap the Window Thing through hole in glass, line up carrier and insert the screw. They install with just a Phillips screwdriver. Glass Breakage is almost impossible because Window Things are made of Zytel ST801 by Dupont.

CRL Plastic Auto Glass Rivets

- Precision-Molded Nylon
- Dozens of Applications

CRL Plastic Rivets are made from precision-molded nylon, and designed as original equipment part numbers for Ford, Chrysler and General Motors vehicles. Each year, car makers use millions of Plastic Rivets to attach bumper fascia strips, secure inner fenders, and mount dozens of subassemblies and parts. To assure appropriate appearance and structural balance, replace OEM parts with CRL Plastic Rivets. In addition to the automotive applications listed, many fastening situations call for Plastic Rivets.

For instance, properly selected, the Plastic Rivets below are ideal for use in non-conductive and non-corrosive environments. When a plastic rivet is set, it forms three "legs" that compress against the blind side of the work, securely locking components in place. You can't get a better grip from any other plastic rivet fastener. For trouble-free installation, use the CRL Cat. No. 48000 Plastic Rivet Setter (See page A292).



Actual Size Plastic Rivet Guide

Place your plastic rivets up against this drawing to match the sizes you are using to our catalog numbers. All plastic rivets are available in packages of 100.

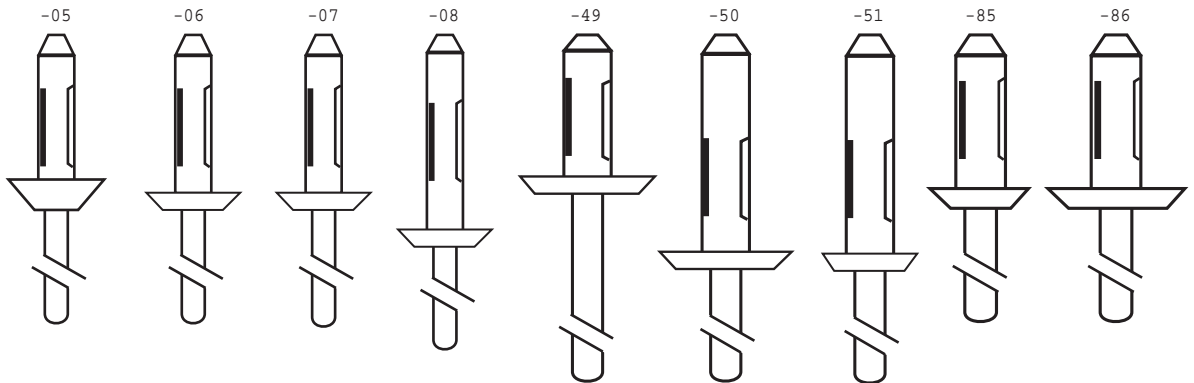

 <p>Grip Range .059-.177" (1.5-4.5 mm) Rivet Dia. .195" (5 mm) Flange Dia. .472" (12 mm) Drill Hole Dia. .197" (5 mm) OEM Ref: GM 20423647</p> <p>Qty/Pkg 100 CAT. NO. 48305</p>	 <p>Grip Range .118-.236" (3-6 mm) Rivet Dia. .195" (5 mm) Flange Dia. .472" (12 mm) Drill Hole Dia. .197" (5 mm) OEM Ref: GM 20432975, Chrysler 6500899, VW 175-853-577</p> <p>Qty/Pkg 100 CAT. NO. 48306</p>	 <p>Grip Range .118-.177" (3-4.5 mm) Rivet Dia. .195" (5 mm) Flange Dia. .472" (12 mm) Drill Hole Dia. .197" (5 mm) OEM Ref: Chrysler 6500859</p> <p>Qty/Pkg 100 CAT. NO. 48307</p>
 <p>Grip Range .236-.394" (6-10 mm) Rivet Dia. .195" (5 mm) Flange Dia. .472" (12 mm) Drill Hole Dia. .197" (5 mm) OEM Ref: Chrysler 6500898</p> <p>Qty/Pkg 100 CAT. NO. 48308</p>	 <p>Grip Range .157-.236" (4-6 mm) Rivet Dia. .246" (6.3 mm) Flange Dia. .669" (17 mm) Drill Hole Dia. .248" (6.3 mm) OEM Ref: GM 14070914</p> <p>Qty/Pkg 100 CAT. NO. 48349</p>	 <p>Grip Range .157-.394" (4-10 mm) Rivet Dia. .246" (6.3 mm) Flange Dia. .669" (17 mm) Drill Hole Dia. .248" (6.3 mm) OEM Ref: GM14063981, Chrysler 6500911, AMC 8934-201-631, Ford N803043S</p> <p>Qty/Pkg 100 CAT. NO. 48350</p>
 <p>Grip Range .157-.394" (4-6 mm) Rivet Dia. .246" (6.3 mm) Flange Dia. .512" (13 mm) Drill Hole Dia. .248" (6.3 mm) OEM Ref: GM 20452072</p> <p>Qty/Pkg 100 CAT. NO. 48351</p>	 <p>Grip Range .098-.197" (2.5-5 mm) Rivet Dia. .258" (6.5 mm) Flange Dia. .512" (13 mm) Drill Hole Dia. .260" (6.6 mm) OEM Ref: GM 20421672</p> <p>Qty/Pkg 100 CAT. NO. 48385</p>	 <p>Grip Range .098-.197" (2.5-5 mm) Rivet Dia. .258" (6.5 mm) Flange Dia. .709" (18 mm) Drill Hole Dia. .260" (6.6 mm) OEM Ref: GM 20433026, VW 175-853-577A</p> <p>Qty/Pkg 100 CAT. NO. 48386</p>



CRL Blind and Specialty Rivets



CRL Blind Rivets in Packs of 1,000



Our more popular sizes of Blind Rivets are available in packages of 1,000 each. This is an economical alternative to ordering factory cases for sizes that you may use infrequently or in limited amounts. Sizes and colors not shown here may also be special ordered. Contact CRL Customer Service for pricing and availability.

ALL STAINLESS STEEL RIVETS

CAT. NO.	DIAMETER	GRIP RANGE
FBF42PK	1/8" (3.1mm)	1/16" to 1/8"
FBF43PK	1/8" (3.1mm)	1/8" to 3/16"
FBF44PK	1/8" (3.1mm)	3/16" to 1/4"
FBF46PK	1/8" (3.1mm)	5/16" to 3/8"
FBF48PK	1/8" (3.1mm)	3/8" to 1/2"
FBF54PK	5/32" (4 mm)	3/16" to 1/4"
FBF56PK	5/32" (4 mm)	1/4" to 3/8"
FBF64PK	3/16" (4.8 mm)	1/8" to 1/4"
FBF66PK	3/16" (4.8 mm)	1/4" to 3/8"

ALUMINUM RIVETS, ALUMINUM MANDRELS

CAT. NO.	DIAMETER	GRIP RANGE
ABA41PK	1/8" (3.1 mm)	0" to 1/16"
ABA42PK	1/8" (3.1 mm)	1/16" to 1/8"
ABA43PK	1/8" (3.1 mm)	1/8" to 1/16"
ABA44PK	1/8" (3.1 mm)	3/16" to 1/4"
ABA45PK	1/8" (3.1 mm)	1/4" to 5/16"
ABA46PK	1/8" (3.1 mm)	5/16" to 3/8"
ABA48PK	1/8" (3.1 mm)	3/8" to 1/2"
ABA52PK	5/32" (4 mm)	0" to 1/8"
ABA54PK	5/32" (4 mm)	3/16" to 1/4"
ABA56PK	5/32" (4 mm)	1/4" to 3/8"
ABA58PK	5/32" (4 mm)	3/8" to 1/2"
ABA62PK	3/16" (4.8 mm)	0" to 1/8"
ABA64PK	3/16" (4.8 mm)	1/8" to 1/4"
ABA66PK	3/16" (4.8 mm)	1/4" to 3/8"
ABA68PK	3/16" (4.8 mm)	3/8" to 1/2"
ABA610PK	3/16" (4.8 mm)	1/2" to 5/8"

ALUMINUM RIVETS, STEEL MANDRELS

CAT. NO.	DIAMETER	GRIP RANGE
ABS42PK	1/8" (3.1 mm)	1/16" to 1/8"
ABS43PK	1/8" (3.1 mm)	1/8" to 3/16"
ABS44PK	1/8" (3.1 mm)	3/16" to 1/4"
ABS45PK	1/8" (3.1 mm)	1/4" to 5/16"
ABS46PK	1/8" (3.1 mm)	5/16" to 3/8"
ABS48PK	1/8" (3.1 mm)	3/8" to 1/2"
ABS56PK	5/32" (4 mm)	1/4" to 3/8"
ABS64PK	3/16" (4.8 mm)	1/8" to 1/4"
ABS66PK	3/16" (4.8 mm)	1/4" to 3/8"
ABS68PK	3/16" (4.8 mm)	3/8" to 1/2"

STEEL RIVETS, STEEL MANDRELS

CAT. NO.	DIAMETER	GRIP RANGE
SBS42PK	1/8" (3.1 mm)	1/16" to 1/8"
SBS44PK	1/8" (3.1 mm)	3/16" to 1/4"
SBS48PK	1/8" (3.1 mm)	3/8" to 1/2"

CRL Quick-Snap Rivets

- Rivet-On Snap Fastener
- Installs in Seconds with a Standard Rivet Gun

Ideal companions to standard canvas snap fasteners used on truck bodies, boats, etc. Snap head is durable brass with bright nickel plating. Mandrel is stainless steel. Install using a standard rivet gun with a 1/8" nosepiece. 100 per package.



CAT. NO.	RIVET DIAMETER	GRIP RANGE
BSS43SH	1/8" (3.1 mm)	.060 to .187
BSS46SH	1/8" (3.1 mm)	.185 to .375

Sizes can be combined for quantity pricing.

CRL Square Steel Spacers

- Give Extra Support on Soft Surfaces

CRL Square Steel Spacers are for use as back-up washers when rivets are used to fasten soft materials. Access to both sides of material is necessary for proper performance. Spacers are 1/16" thick.

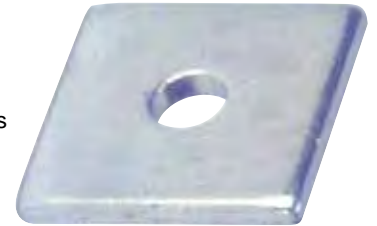

CAT. NO.	HOLE SIZE	QTY/PKG
SS4	1/8" (3.1 mm)	500
SS6	3/16" (4.8 mm)	500

CRL Rivet Head Removal Tool

- Cuts Heads Off Door Regulator Rivets
- 1/4" Shank Fits All Drills
- Hollow Center Catches Rivet Stem



CAT. NO. 72181

The CRL Rivet Head Removal Tool is perfect for the removal of rivets that hold door regulators in place. A hardened steel tip cuts off the rivet head, and the hollow center catches the rivet stem. 3" (76 mm) overall length with 1/4" shank to fit most electric drills.

CRL Rivet Eater new

- 6" Length for Hard-To-Reach Regulator Rivets in Vehicle Doors
- Removes Recessed Rivet Heads Fast



CAT. NO. RE38

The CRL Rivet Eater, with its 6" (152 mm) length, easily removes the heads of recessed door regulator rivets in vehicle doors. It lets you get at rivets through small access holes, and has a hollow center so you can use the rivet stem as a guide. Sharpened tip removes the rivet head fast. 3/8" shank allows you to use it in most any cordless drill.



CRL Auto Glass Rivet Tools

CRL Marson "Big Daddy" Riveter

- Extremely Popular Auto Shop Rivet Setter
- Excellent for Window Regulator and Glass Stop Rivets



The CRL Marson "Big Daddy" Riveter lets you work in hard-to-get-to areas. Use it to replace window regulator and glass stop rivets on General Motors, Ford, and Chrysler cars, plus door handle rivets on Ford, Mercury, and Lincoln cars. The special nosepiece provided with the tool must be used for these applications. 3/16" and 1/4" nosepieces for other rivet applications are stored in the body of the tool.

CAT. NO.	DESCRIPTION
39010	"Big Daddy" Riveter
96026	3/16" Nosepiece Replacement
96027	1/4" Nosepiece Replacement
96028	Klik-Split Rivet Nosepiece Replacement
39010JAWS	Replacement Jaws
39009	Long Nose Adapter

CRL Heavy-Duty Automotive Riveter

- Tremendous Power for Large Rivets
- Extra Heavy-Duty Tool Used in Auto Glass Shops
- Equipped with Three Long Nosepieces



This extra heavy-duty CRL Automotive Riveter allows riveting in areas where other tools won't reach. Exerts tremendous pulling power for large rivets. Shock resistant curved handles. Equipped with three nosepieces conveniently stored on the handle. Nosepieces set 5/32", 1/8", and 3/32" rivets, plus there's a special nosepiece for inserting door handle rivets for the automotive industry.

CAT. NO.	DESCRIPTION
79034	Heavy-Duty Riveter with Nosepieces
96013	Replacement Jaws

CRL Hydraulic Rivet Gun

- Develops Up to 3,500 Pounds of Pulling Power

This Hydraulic Rivet Gun develops up to 3,500 pounds of rivet pulling power, capable of setting 1/4" diameter automotive rivets. Includes four nosepieces for setting rivets of 1/8", 5/32", 3/16", and 1/4" diameter; 1/4" split rivet nosepiece; high impact plastic carrying case. A strong yet simple tool for doing those big rivet setting jobs.



CAT. NO. RG1105

CRL Marson Heavy-Duty Rivet Gun

- Includes Four Nosepieces for Rivets from 3/32" to 3/16"



The CRL Marson Heavy-Duty Rivet Gun features heavy-duty construction and includes four nosepieces that are housed in the tool body. Will set 3/32", 1/8", 5/32", and 3/16" rivet sizes.

CAT. NO.	DESCRIPTION
HP2	Heavy-Duty Rivet Gun
HP23A	Replacement Jaws

CRL Plastic Rivet Setter

- Available as a Complete Kit, or Just the Tool Only



This kit contains our Plastic Rivet Setting Tool and a package of the four most popular plastic rivet sizes. The tool delivers the extra long pulling stroke needed to set plastic rivets, plus all steel construction and full size handles for easy operation. Tool also available separately.

CAT. NO.	DESCRIPTION
48001	Complete Rivet Setter Kit
48000	Rivet Setter Tool Only

CRL Rotating Head Rivet Gun

- Head Rotates a Full 360 Degrees

new

The Rotating Head Rivet Gun allows you to rivet at any angle because the head rotates a full 360 degrees. All steel construction with vinyl grips, and supplied with four nosepieces: 3/32", 1/8", 5/32", and 3/16".



CAT. NO. RHT300



CRL Vise Grip Clinching Attachment Kit

- Cost Effective Repair System Converts Vise Grip Pliers Into a Snap Fastener Installation Tool
- A Must for Every Upholstery Shop

The CRL Vise Grip Clinching Attachment Kit provides an easy remedy to broken or missing snap fasteners. The CRL Vise Grip Clinching Attachment Kit converts included 10" Vise Grip Pliers into a snap fastener repair tool. The Clincher and Anvil slide over the jaws of the pliers and provide the base to hold and flare the eyelet stems.

Includes a special 3-piece hole punch set, over 330 assorted fasteners, and 10" Vise Grip Pliers in a plastic carrying case. Everything you need to clinch snaps, buttons, grommets, rivets, center punch, countersink and clamp soft, fragile plated or painted materials.



CAT. NO. T54

CRL Stud and Eyelet Fastening Kit



CAT. NO. TS12K

This CRL Stud and Eyelet Fastening Kit provides an easy remedy to broken or missing snap fasteners. The CRL Stud and Eyelet Fastening Kit converts your Vise Grip Pliers into a snap fastener repair tool. The Clincher and Anvil slide over the jaws of the pliers and provide the base to hold and flare the eyelet stems. The Kit contains the following pieces: six AV7679 Eyelet Studs, AV7682 Eyelets, one Anvil, and one Clincher. Vise Grips not included.

CRL Button and Socket Fastening Kit



CAT. NO. TS11K

This CRL Button and Socket Fastening Kit provides an easy remedy to broken or missing snap fasteners. The CRL Button and Socket Fastening Kit converts your Vise Grip Pliers into a snap fastener repair tool. The Clincher and Anvil slide over the jaws of the pliers and provide the base to hold and flare the eyelet stems. The Kit contains the following pieces: six AV7677 Buttons, AV7678 Snap Sockets, one Anvil, and one Clincher. Vise Grips not included.

CRL Upholstery Fasteners

- For Use with Our TS12K or TS11K CRL Upholstery Fastening Kits

All boxes of Upholstery Fasteners can be combined for quantity pricing.

CRL Nickel on Brass Socket



Qty/Box 100
CAT. NO. AV7678

CRL Nickel on Brass Stud (Clinch Type)



Qty/Box 100
CAT. NO. AV7679

CRL Nickel on Brass Clinch Phillips Head Wood Screw (5/8" Stud Length)



Qty/Box 100
CAT. NO. AV7680

CRL Nickel on Brass Button



Qty/Box 100
CAT. NO. AV7677

CRL Nickel on Brass Eyelet 1/4" Barrel



Qty/Box 100
CAT. NO. AV7682

CRL Nickel on Brass Clinch with Phillips Head Wood Screw (3/8" Stud Length)



Qty/Box 100
CAT. NO. AV9814

CRL Oval Head Phillips Tapping Screw "Fix-Kit"



CAT. NO. AV6003

- 24 Varieties
- 540 Pieces
- Metal Case



This CRL "Fix-Kit" contains 24 sizes of Oval Head Phillips Tapping Screws commonly used by auto glass shops. The sturdy, compartmented metal case is indexed for picking the fastener you need quickly and easily.

ORDER REFILLS FROM THE CATALOG NUMBERS LISTED BELOW.

CAT. NO.	SIZE/TYPE	CAT. NO.	SIZE/TYPE
AV3069	4 x 3/4" Oval Head	AV1802	8 x 1-1/8" #6 Head
AV1793	6 x 5/8" Oval Head	AV2361	8 x 1-1/4" Oval Head
AV1794	6 x 3/4" Oval Head	AV1803	8 x 1-1/4" #6 Head
AV1796	6 x 1" Oval Head	AV2362	8 x 1-1/2" Oval Head
AV1797	6 x 1-1/4" Oval Head	AV1932	8 x 1-1/2" #6 Head
AV2024	8 x 3/8" #6 Head	AV1933	8 x 1-3/4" #6 Head
AV2358	8 x 1/2" Oval Head	AV1717	10 x 3/4" #8 Head
AV2027	8 x 1/2" #6 Head	AV2728	10 x 3/4" Oval Head
AV1421	8 x 5/8" #6 Head	AV1804	10 x 1" #6 Head
AV1799	8 x 3/4" #6 Head	AV1807	10 x 1-1/8" Oval Head
AV2359	8 x 3/4" Oval Head	AV2046	10 x 1-1/2" #6 Head
AV1801	8 x 1" #6 Head	AV2047	10 x 1-3/4" #6 Head

CRL Specialty Tapping Screw "Fix-Kit"



CAT. NO. AV6004

- 24 Varieties
- 795 Pieces
- Metal Case



This CRL "Fix-Kit" contains 24 sizes of Specialty Tapping Screws commonly used by auto glass shops. The sturdy, compartmented metal case is indexed for picking the fastener you need quickly and easily.

ORDER REFILLS FROM THE CATALOG NUMBERS LISTED BELOW.

CAT. NO.	SIZE/TYPE	CAT. NO.	SIZE/TYPE
AV1936	6 x 3/8" Pan Head	AV2365	8 x 3/4" Pan Head
AV1937	6 x 1/2" Pan Head	AV3079	8 x 1" Pan Head
AV2364	6 x 3/4" Pan Head	AV2178	10 x 3/8" Rnd Wshr Hd
AV1939	8 x 3/8" Pan Head	AV1943	10 x 1/2" Pan Head
AV10642	8 x 3/8" Oval Wshr Hd	AV2808	10 x 5/8" Pan Head
AV2805	8 x 7/16" Pan Wshr Hd	AV13709	10 x 3/4" Rnd Wshr Hd
AV1940	8 x 1/2" Pan Head	AV2366	10 x 3/4" Pan Head
AV12095	8 x 1/2" Pan Wshr Hd	AV3082	10 x 1" Pan Head
AV14859	8 x 1/2" Flat Wshr Hd	AV2367	12 x 3/4" Pan Head
AV15171	8 x 1/2" Rnd Wshr Tek	AV3086	12 x 1" Pan Head
AV15172	8 x 1/2" Flat Wshr Tek	AV3089	14 x 1/2" Pan Head
AV1712	8 x 3/4" #6 Flat Head	AV3090	14 x 3/4" Pan Head

CRL Tek® Self-Drilling Screw "Fix-Kit"



CAT. NO. AV6144

- 16 Varieties
- 365 Pieces
- Metal Case

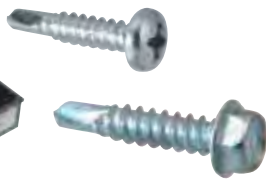

This CRL "Fix-Kit" contains a complete assortment of Tek® Self-Drilling Screws with Posi-Driv Pan and Hex Washer heads. All are zinc plated.

ORDER REFILLS FROM THE CATALOG NUMBERS LISTED BELOW.

CAT. NO.	SIZE/TYPE	CAT. NO.	SIZE/TYPE
AV9605	8 x 1/2" Pan Head	AV9614	10 x 5/8" Hex Head
AV9606	8 x 3/4" Pan Head	AV9615	10 x 3/4" Hex Head
AV9607	10 x 1/2" Pan Head	AV9616	10 x 1" Hex Head
AV9608	10 x 3/4" Pan Head	AV11911	12 x 1" Hex Head
AV11905	12 x 1" Pan Head	AV9620	14 x 3/4" Hex Head
AV9611	8 x 1/2" Hex Head	AV11914	14 x 1" Hex Head
AV9612	8 x 3/4" Hex Head	AV11915	14 x 1-1/4" Hex Head
AV9613	10 x 1/2" Hex Head	AV11916	14 x 1-1/2" Hex Head

CRL Countersunk Washer Head Screw "Fix-Kit"



CAT. NO. AV6049

- 12 Varieties
- 460 Pieces
- Metal Case



This CRL "Fix-Kit" contains a complete assortment of chrome plated, Phillips Countersunk Washer Head Screws.

ORDER REFILLS FROM THE CATALOG NUMBERS LISTED BELOW.

CAT. NO.	SIZE/TYPE	CAT. NO.	SIZE/TYPE
AV3537	6 x 5/8" #6 Head	AV2773	8 x 1-1/4" #6 Head
AV3538	6 x 3/4" #6 Head	AV14970	8 x 1-1/2" #6 Head
AV3539	6 x 1" #6 Head	AV3465	10 x 5/8" #8 Head
AV2771	8 x 5/8" #6 Head	AV3466	10 x 3/4" #8 Head
AV2751	8 x 3/4" #6 Head	AV3467	10 x 1" #8 Head
AV2772	8 x 1" #6 Head	AV3468	10 x 1-1/4" #8 Head



CRL Oval Head Phillips Tapping Screws

- 100 Per Box
- 1 Box Minimum Order



Oval







































Phillips



Tapping

All boxes of Automotive Screws can be combined for quantity pricing.

 4 x 3/4" Chrome CAT. NO. AV3069	 6 x 1/2" Chrome CAT. NO. AV2698	 6 x 5/8" Chrome CAT. NO. AV1793	 6 x 3/4" Chrome CAT. NO. AV1794
 6 x 1" Chrome CAT. NO. AV1796	 6 x 1-1/4" Chrome CAT. NO. AV1797	 8 x 3/8" #6 Head Chrome CAT. NO. AV2024	 8 x 3/8" Chrome CAT. NO. AV3485
 8 x 1/2" #6 Head Chrome CAT. NO. AV2027	 8 x 1/2" Zinc CAT. NO. AV2358	 8 x 1/2" Chrome CAT. NO. AV2707	 8 x 5/8" #6 Head Chrome CAT. NO. AV1421
 8 x 3/4" #6 Head Chrome CAT. NO. AV1799	 8 x 3/4" Zinc CAT. NO. AV2359	 8 x 3/4" Chrome CAT. NO. AV2710	 8 x 1" #6 Head Zinc CAT. NO. AV1801
 8 x 1" Chrome CAT. NO. AV2713	 8 x 1-1/8" #6 Head Chrome CAT. NO. AV1802	 8 x 1-1/4" #6 Head Zinc CAT. NO. AV1803	 8 x 1-1/4" #6 Head Chrome CAT. NO. AV1423
 8 x 1-1/4" Zinc CAT. NO. AV2361	 8 x 1-1/4" Chrome CAT. NO. AV2716	 8 x 1-1/2" #6 Head Chrome CAT. NO. AV1932	 8 x 1-1/2" Zinc CAT. NO. AV2362
 8 x 1-1/2" Chrome CAT. NO. AV2718	 8 x 1-3/4" #6 Head Chrome CAT. NO. AV1933	 8 x 1-3/4" Zinc CAT. NO. AV2631	 8 x 2" #6 Head Zinc CAT. NO. AV2632
 8 x 2" Zinc CAT. NO. AV2633	 10 x 1/2" Chrome CAT. NO. AV2722	 10 x 3/4" Chrome CAT. NO. AV2728	 10 x 3/4" #8 Head Chrome CAT. NO. AV1717
 10 x 1" #6 Head Chrome CAT. NO. AV1804	 10 x 1-1/8" Chrome CAT. NO. AV1807	 10 x 1-1/2" #6 Head Chrome CAT. NO. AV2046	 10 x 1-3/4" #6 Head Chrome CAT. NO. AV2047
 10 x 2" Zinc CAT. NO. AV2666	<p>Need a replacement clip, fastener, molding or weatherstrip for a certain vehicle, but haven't been able to find it? CRL can help! We have numerous sources for auto glass replacement parts. Contact CRL Automotive Technical Sales at (800) 421-6144, and let us know what you are looking for. You may also send a sample of what you need to: CRL Automotive Technical Sales, 2503 E. Vernon Avenue, Los Angeles, CA 90058. We'll do our best to help you find the right part.</p>		



CRL AUTO GLASS REPLACEMENT COMPONENTS

For Pricing on CRL Products, Call Toll Free (800) 421-6144, or Visit crlaurence.com

CRL Pan Head Phillips Tapping Screws

- 100 Per Box
- 1 Box Minimum Order

All boxes of Automotive Screws can be combined for quantity pricing.



Pan



Phillips



Tapping

 4 x 1/4" Zinc CAT. NO. AV3071	 4 x 3/8" Zinc CAT. NO. AV3072	 4 x 1/2" Zinc CAT. NO. AV3073	 6 x 1/4" Zinc CAT. NO. AV1935
 6 x 3/8" Zinc CAT. NO. AV1936	 6 x 1/2" Zinc CAT. NO. AV1937	 6 x 3/4" Zinc CAT. NO. AV2364	 8 x 3/8" Zinc CAT. NO. AV1939
 8 x 7/16" Chrome CAT. NO. AV1826	 8 x 1/2" Zinc CAT. NO. AV1940	 8 x 3/4" Zinc CAT. NO. AV2365	 8 x 1" Zinc CAT. NO. AV3079
 8 x 1-3/4" Zinc CAT. NO. AV2088	 10 x 3/8" Zinc CAT. NO. AV1942	 10 x 1/2" Zinc CAT. NO. AV1943	 10 x 5/8" Zinc CAT. NO. AV2808
 10 x 3/4" Zinc CAT. NO. AV2366	 10 x 1" Zinc CAT. NO. AV3082	 12 x 3/4" Zinc CAT. NO. AV2367	 12 x 1" Zinc CAT. NO. AV3086
 14 x 1/2" Zinc CAT. NO. AV3089	 14 x 3/4" Zinc CAT. NO. AV3090	 14 x 2" Zinc CAT. NO. AV5634	 14 x 2-1/4" Zinc CAT. NO. AV2371

CRL Flat Head Phillips Tapping Screws

- 100 Per Box
- 1 Box Minimum Order

All boxes of Automotive Screws can be combined for quantity pricing.











Flat



Phillips



Tapping

 4 x 1/4" Zinc CAT. NO. AV5646	 4 x 3/8" Zinc CAT. NO. AV5647	 4 x 1/2" Zinc CAT. NO. AV5648	 6 x 5/16" #4 Head Zinc CAT. NO. AV2736
 6 x 1/2" Zinc CAT. NO. AV1946	 8 x 7/16" #6 Head Zinc CAT. NO. AV1479	 8 x 1/2" #5 Head Zinc CAT. NO. AV1711	 8 x 3/4" #6 Head Zinc CAT. NO. AV1712



LOG ON TO crlaurence.com FOR BUSINESS-TO-BUSINESS SERVICES

A296 | PHONE (800) 421-6144 | FAX (800) 262-3299 TOLL FREE FROM ANYWHERE IN THE U.S.A. OR CANADA

CRL AUTO GLASS REPLACEMENT COMPONENTS

For Pricing on CRL Products, Call Toll Free (800) 421-6144, or Visit crlaurence.com

CRL Hex Washer Head Tek® Screws

• 100 Per Box*

• 1 Box Minimum Order

*Unless shown otherwise. All boxes of Automotive Screws can be combined for quantity pricing.

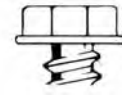













Hex Washer



Hex



Self Drilling

 8 x 7/16" Zinc CAT. NO. AV9610	 8 x 1/2" Zinc CAT. NO. AV9611	 8 x 3/4" Zinc CAT. NO. AV9612	 10 x 1/2" Zinc CAT. NO. AV9613
 10 x 5/8" Zinc CAT. NO. AV9614	 10 x 3/4" Zinc CAT. NO. AV9615	 10 x 1" Zinc CAT. NO. AV9616	 12 x 1" Zinc CAT. NO. AV11911 25 per Box
 14 x 3/4" Zinc CAT. NO. AV9620	 14 x 1" Zinc CAT. NO. AV11914 25 per Box	 14 x 1-1/4" Zinc CAT. NO. AV11915 25 per Box	 14 x 1-1/2" Zinc CAT. NO. AV11916 25 per Box

CRL Pan Head Phillips Tek® Screws

• 100 Per Box*

• 1 Box Minimum Order

* Unless shown otherwise. All boxes of Automotive Screws can be combined for quantity pricing.









Pan



Phillips



Self Drilling

 8 x 7/16" Zinc CAT. NO. AV9604	 8 x 1/2" Zinc CAT. NO. AV9605			
 8 x 3/4" Zinc CAT. NO. AV9606	 10 x 1/2" Zinc CAT. NO. AV9607	 10 x 3/4" Zinc CAT. NO. AV9608	 10 x 1" Zinc CAT. NO. AV9609	 12 x 1" Zinc CAT. NO. AV11905 50 per Box

CRL Oval Head Phillips Countersunk Washer Tapping Screws

• 100 Per Box*

• 1 Box Minimum Order

* Unless shown otherwise. All boxes of Automotive Screws can be combined for quantity pricing.



Oval



Phillips



Tapping

 6 x 5/8" Chrome CAT. NO. AV3537	 6 x 5/8" Black CAT. NO. AV11784	 6 x 3/4" Chrome CAT. NO. AV3538	 6 x 3/4" Black CAT. NO. AV11785
 6 x 1" Chrome CAT. NO. AV3539	 8 x 5/8" Black CAT. NO. AV11786	 8 x 5/8" #6 Head Chrome CAT. NO. AV2771	 8 x 5/8" #6 Head Black CAT. NO. AV11787
 8 x 3/4" #6 Head Chrome CAT. NO. AV2751	 8 x 3/4" #6 Head Black CAT. NO. AV11788	 8 x 1" #6 Head Chrome CAT. NO. AV2772	 8 x 1" #6 Head Black CAT. NO. AV11789
 8 x 1-1/4" #6 Head Chrome CAT. NO. AV2773	 8 x 1-1/4" #6 Head Black CAT. NO. AV11790	 10 x 5/8" #8 Head Chrome CAT. NO. AV3465	 10 x 3/4" #8 Head Black CAT. NO. AV11791 50 per Box
 10 x 3/4" #8 Head Chrome CAT. NO. AV3466	 10 x 1" #8 Head Chrome CAT. NO. AV3467	 10 x 1-1/4" #8 Head Chrome CAT. NO. AV3468	<p>MORE SCREWS Go to crlaurence.com and look up "Screws" in our A to Z Index. You'll find over three dozen listings!</p>

LOG ON TO crlaurence.com FOR BUSINESS-TO-BUSINESS SERVICES

PHONE (800) 421-6144 | FAX (800) 262-3299 TOLL FREE FROM ANYWHERE IN THE U.S.A. OR CANADA | A297



CRL Oval Head Phillips Countersunk Washer Tek® Screws

• 50 or 100 Per Box

• 1 Box Minimum Order

All boxes of Automotive Fasteners can be combined for quantity pricing.



<p>8 x 5/8" Flush Chrome CAT. NO. AV11448 100/Box</p>	<p>8 x 5/8" Flush Black CAT. NO. AV11453 100/Box</p>	<p>8 x 5/8" Countersunk Chrome CAT. NO. AV11449 100/Box</p>	<p>8 x 5/8" Countersunk Black CAT. NO. AV11454 100/Box</p>
<p>8 x 3/4" Countersunk Chrome CAT. NO. AV11450 100/Box</p>	<p>8 x 3/4" Countersunk Black CAT. NO. AV11455 100/Box</p>	<p>8 x 1" Countersunk Chrome CAT. NO. AV11451 50/Box</p>	<p>8 x 1" Countersunk Black CAT. NO. AV11456 50/Box</p>
<p>8 x 1-1/4" Countersunk Chrome CAT. NO. AV11452 50/Box</p>	<p>8 x 1-1/4" Countersunk Black CAT. NO. AV11457 50/Box</p>	<p>Need a replacement fastener or washer for a certain vehicle, but haven't been able to find it? CRL can help! Contact CRL Automotive Technical Sales at (800) 421-6144, and let us know what you are looking for. You may also send a sample of what you need to: CRL Automotive Technical Sales, 2503 E. Vernon Avenue, Los Angeles, CA 90058. We'll do our best to help you find the right part.</p>	

CRL Specialty Screws and Washers

All Boxes of Automotive Fasteners can be combined for quantity pricing.

T-Stud Screw



Screw-In Stud
Replaces Weld-on Stud
4 x 3/8" Flat Head Phillips

Qty/Box 100

CAT. NO. CP683163

T-Stud Screw



Screw-In Stud
Replaces Weld-on Stud
4 x 3/8" Flat Head Phillips; 1/8" Shoulder

Qty/Box 100

CAT. NO. CP774446

Boot Well and Weatherstrip Rail Screw



10 x 1/2" with 1/2" Diameter Head
Convertible and Hardtop
Ford and GM Products

Qty/Box 100

CAT. NO. CP651102

Reveal Molding Screw



Attaching Screw with Sealer
Windshield and Rear Window Reveal Molding
8 x 3/8" Oval Head Phillips
Ford, GM, Chrysler

Qty/Box 100

CAT. NO. CP754194

Reveal Molding Screw



Attaching Screw
Windshield and Rear Window Reveal Molding
8 x 3/8" Oval Head Phillips
Chrysler

Qty/Box 100

CAT. NO. CP683236

Stamped Nut with Sealer



M4-0.7 Thread Pitch; 14 mm Flange with Sealer;
9 mm Across the Flats
Ford Trucks, Back or Side Glass, General Use

Qty/Box 50

CAT. NO. CP927026

Countersunk Washers

Nickel Plated Brass



CAT. NO.	SIZE
AV614	6
AV616	8
AV618	10
AV619	12

Qty/Box 100

Countersunk Flanged Washers

Nickel Plated Brass



CAT. NO.	SIZE
AV3469	6
AV2515	8
AV3471	10

Qty/Box 100

Flush Type Washers

Nickel Plated Brass



CAT. NO.	SIZE
AV602	6
AV604	8

Qty/Box 100

Lock Washers

Zinc Plated



CAT. NO.	SIZE
AV3416	#6 Screw or 1/8"
AV5720	1/4"

Qty/Box 200

Flat Washers

Zinc Plated



CAT. NO.	SIZE
AV2007	3/16" x 1/2"
AV2008	1/4" x 5/8"
AV2333	1/4" x 1-1/4"
AV1376	5/16" x 3/4"
AV768	5/16" x 1-1/4"
AV2227	3/8" x 1-1/2"

Qty/Box 100

Hexagon Nuts

Zinc Plated



CAT. NO.	SIZE
N632	6-32
N832	8-32
N1024	10-24
N1032	10-32
N1224	12-24
N1420	1/4"-20

Qty/Box 100



LOG ON TO crlaurence.com FOR BUSINESS-TO-BUSINESS SERVICES

A298 | PHONE (800) 421-6144 | FAX (800) 262-3299 TOLL FREE FROM ANYWHERE IN THE U.S.A. OR CANADA

CRL SP1500 Power Inverter

new

- Provides 115 Volts AC from 12 Volt DC Source
- True Sine Wave Output for Perfect Tool Performance

The CRL SP1500 Power Inverter has a true sine wave (the same as you get from a wall outlet), producing the kind of power required to run tools such as the Fein Knife. Use the two AC receptacles to power cut-out tools, a vacuum cleaner, and other power tools used by mobile glass operations. The anodized aluminum case provides durability and maximum heat dissipation, and has a built-in cooling fan. **NOTE:** One Connector Cable Set is required for proper connection of Inverter to vehicle. Cable Set must be long enough to connect Inverter to vehicle battery. Be sure to order adequate length.



CAT. NO. SP1500

Continuous Output: 1500 Watts
Peak Load Rating: 4500 Watts
Output Voltage: 120V AC RMS
Output Frequency: 60Hz +/- 0.5%
Dimensions: 14-1/4" by 11-7/8" by 4-5/16"
Weight: 28.2 lbs. (12.8 kg)



CAT. NO.	LENGTH OF CABLES
4AWG3	3 Ft (91 cm)
4AWG6	6 Ft (183 cm)
4AWG12	12 Ft (366 cm)

CRL PB12300 Power Inverter

new

- Provides 115 Volts AC Power from 12 Volt DC Source
- Excellent for Field Use of Power Tools

The CRL PB12300 Power Inverter will provide 2300 watts of continuous power, with a peak surge of 4600 watts. Use the two AC receptacles to power cut-out tools, a vacuum cleaner, or other power tools used by mobile glass operations. The compact design allows this unit to be mounted under the seat for security. A digital LED display shows input DC voltage or output wattage. The anodized aluminum case provides durability and maximum heat dissipation, and has a built-in cooling fan. **NOTE:** One Connector Cable Set is required for proper connection of Inverter to vehicle. Cable Set must be long enough to connect Inverter to vehicle battery. Be sure to order adequate length.



CAT. NO. PB12300

Continuous Output: 2300 Watts
Peak Load Rating: 4600 Watts
Output Voltage: 117V AC +/- 10%
Output Frequency: 60Hz +/- 3Hz
Dimensions: 13-15/16" by 10-5/16" by 3-1/8"
Weight: 12 lbs. (5.3 kg)



CAT. NO.	LENGTH OF CABLES
2AWG3	3 Ft (91 cm)
2AWG6	6 Ft (183 cm)
2AWG12	12 Ft (366 cm)

CRL Nylon Cable Ties

- Convenient and Simple to Use
- Available in Four Lengths and Two Colors

CRL Nylon Cable Ties are convenient for bundling wires, cables, or other narrow components. Especially useful for gathering and securing wires under the dash. Simple to use, just insert the tapered end of the strap into head slot and pull until the bundle is secure. 100 nylon ties per pack. Minimum order is one pack.



CAT. NO. NATURAL	CAT. NO. BLACK	STRAP LENGTH	MAXIMUM BUNDLE SIZE
NT40	NT40BL	4" (102 mm)	3/4" (19 mm)
NT56	NT56BL	5.6" (142 mm)	1-1/4" (31 mm)
NT75	NT75BL	7.5" (190 mm)	1-3/4" (44 mm)
NT111	NT111BL	11.1" (282 mm)	3" (76 mm)

Sizes and colors can be combined for quantity pricing.



CRL Vaco Solderless Terminal Kit

- Service Kit Includes Most Commonly Used Terminals and Connectors
- Convenient Box with Clear Lid



CAT. NO. 1398

This compact, all-purpose CRL Connect-All Solderless Terminal Kit has over 165 of the most commonly used solderless terminals and connectors in a handy, refillable tray. The compact box has a clear lid for easy selection, and measures only 7-1/8" by 5-1/8" by 1-1/8" (181 mm by 130 mm by 29 mm) for easy storage in your tool box.

CRL Insulated Solderless Splice Connectors

- Available in Three Sizes
- Quick and Easy Splices
- Simple-to-Use



CRL Insulated Solderless Splice Connectors are the quick and easy way to splice wire without soldering. Simply insert wire ends into the connector, then crimp with Cat. No. AV7711 Crimping Tool or pliers.

CAT. NO.	SIZE	COLOR	QTY/BOX
C67202	22 - 18 Gauge	Pink	100
C67302	16 - 14 Gauge	Blue	100
C67402	12 - 10 Gauge	Yellow	100

CRL Automotive Wire

- Heavy Automotive Gauge
- Great for Power Windows, Sunroofs, Dome Lights, and Accessories Wiring

CRL Heavy Gauge Auto Wire for rewiring power windows, dome lights, sunroofs and more. Comes on convenient 100 foot (30.5 m) spools.



CAT. NO.	SIZE
AW16	16 Gauge
AW18	18 Gauge

CRL Electrical Connector Crimping Tool

- Crimps, Cuts, Slices, Strips
- Cushioned Grip



CAT. NO. AV7711

This CRL Electrical Connector Crimping Tool cuts and strips 22 to 8 gauge wire, and crimps both insulated and non-insulated style terminals. The wire cutter is placed at the tip of the tool to facilitate cutting in cramped quarters. It has cushion grip handles for comfort.

CRL 3M® ScotchLok Auto-Taps

- Makes Wire Splicing Simple
- UL Listed for 300 Volts
- Fits 14, 16, and 18 Gauge Automotive Wire Sizes



CAT. NO. 3M6119



CAT. NO. 3M6126

CRL 3M® ScotchLok Auto-Taps are heavy-duty self-stripping connectors designed for use with automotive wire. Ideal for equipment where tap, in-line, and pigtail splices are required. UL listed for 300 volt tap splicing. Cat. No. 3M6119 is designed to connect 14, 16 or 18 gauge wires to 10 or 12 gauge wires. Cat. No. 3M6126 connects 14, 16, or 18 gauge wires to the same gauge wire. 50 per box.

CRL Heat Sink Forceps

- Use for Soldering, Testing, Heat Sinking
- Tempered Stainless Steel
- Self-Clamping



CAT. NO. 70296
Straight Tips



CAT. NO. 70297
Curved Tips

These CRL Heat Sink Forceps are self-clamping pincers to hold small parts or components, leaving both hands free for other tasks. These 6" (152 mm) tempered stainless steel precision-machined tools feature finely serrated jaws, box joint pivot, three-position ratchet lock. Available with straight or curved tips.



CRL Low Voltage Circuit Tester

- For Use on Any 6 to 12 Volt DC System
- Quickly Tests Circuits for Current
- Lighted Handle Detects Voltage



CAT. NO. KD129

This CRL Low Voltage Circuit Tester is designed for use on all six to 12 Volt DC systems. To use, simply ground the clip to any metallic surface on the car, push the point through the insulation of the cable being tested until it makes contact with the copper conductor inside. The bulb in the handle will then light if the wire is "hot".

CRL Ground Fault Circuit Interrupter

- Connects Between Your Power Tool and 110 Volt AC Outlet to Prevent Electric Shocks
- A Must for Anyone Who Uses Wet-Working Sanders, Drills, Routers or Saws

Ground fault circuit interrupters prevent the risk of electric shock by cutting the electricity off at any sign of a ground fault or short circuit. This takes place within 25/1,000 of a second; enough time to protect your body from injury.

With the CRL GF1 Ground Fault Circuit Interrupter, you are protected against possible shock or electrocution. Because this unit is so compact, you can take it anywhere, or just leave it attached to your power cord. It's a must have item for anyone operating wet-working power tools.



CAT. NO. GF1

CRL 3-Conductor Round Extension Cord

- UL Listed for Indoor/Outdoor Use
- Thermo-Vinyl Cord
- U-Blade Ground



This heavy-duty CRL 3-Conductor Round Extension Cord resists oil, grease, abrasion, and ozone to give long term, dependable service. The standard copper wire stays completely flexible in cold weather. Connectors are molded on.

CAT. NO.	SIZE	LENGTH	AMPS
EC2316025	16/3	25' (7.62 m)	13
EC2316050	16/3	50' (15.2 m)	13
EC4312050	12/3	50' (15.2 m)	15
EC4312100	12/3	100' (30.5 m)	15

CRL 3-Conductor Twist Lock Extension Cord

- UL Listed
- Remains Flexible in Cold Weather
- Molded-On Connector and Plug

This heavy-duty CRL 100 foot (30.5 m) 3-Conductor Twist Lock Extension Cord stays flexible in cold weather and is built to give long, dependable service. Resists oil, grease, abrasion, and ozone. Copper strand conductors are completely flexible. 12/3 size cord is rated at 23 amps.



CAT. NO. EC9315100

CRL Booster Cables

- 12' (3.6 m) Length
- Vinyl Grip Clamps

CRL Booster Cables are heavy ten gauge wire with vinyl grip clamps. 12 foot (3.6 m) long.



CAT. NO. BC1210

CRL 3/4" Electrical Tape

- UL Approved

Designed to insulate wire, pipes, dissimilar metals, etc., CRL Electrical Tape is resistant to weather, water, acids, alkalis, and oils. It has superior conformability and high elongation to give a tight, solid wrap. A silicone spray additive gives it an 18 month shelf life. It practically never telescopes or bleeds. The glossy black tape is 17 mil (0.4 mm) thick. Roll length is 60 feet (18 m).



CAT. NO. 1ET314

Fabricate Your Own Windows with CRL Self-Sealing Weatherstrip

- One-Piece and Two-Piece Rubber Weatherstrips Offer Flexibility of Design
- Perfect for a Multitude of Custom Window Applications
- Provides an Excellent Weatherseal

CRL Rubber Weatherstrip gives you a weatherproof, vibration dampening, energy absorbing method of joining glass, metal, and plastic in a variety of combinations. It's the easiest rubber gasket installation ever developed. No special skill is needed. CRL Rubber Weatherstrip is extruded in many sizes, in one-piece and two-piece designs. Fits glass panel thicknesses from 1/8" to 1/4" (3 mm to 6 mm), and body panel thicknesses from 1/32" to 25/32" (.8 mm to 19 mm). CRL Rubber Weatherstrip retains its shape, and will hold both glass and body panel tightly.

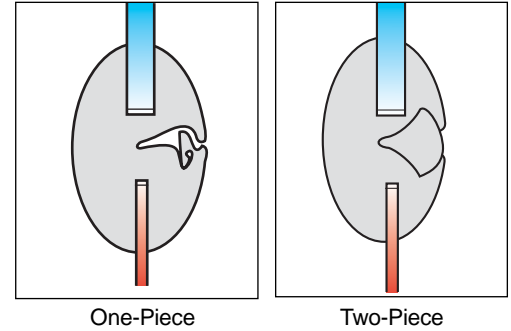

VANS, CAMPERS, AND RV'S: With CRL Rubber Weatherstrip you can easily add windows to flat surfaces on vans, campers, and all types of recreational vehicles. Meets federal push-out requirements.



BIG RIGS: One of the many uses of CRL Rubber Weatherstrip is as a windshield seal on big rig tractors. It offers quick, easy and vibration-proof installations of new or re-glazed windows.



CONSTRUCTION EQUIPMENT: Add windows or re-glaze broken ones on all types of heavy-duty construction vehicles and equipment. No need to track down the original manufacturer's gasket. CRL Rubber Weatherstrip can do the job!



MARINE: Portholes or cabin windows need to be replaced? CRL Rubber Weatherstrip can stand up to the rigors of marine applications. Irregular shapes are no problem, as radiuses as small as 1-1/4" (32 mm) can be accommodated.

SPECIAL ENCLOSURES: CRL Rubber Weatherstrip is ideal for windows in sound booths, sandblasting booths, or other types of enclosures where a flat surface window is required.



YOU CAN DO IT!
CRL Self-Sealing Weatherstrip is very easy to work with. Instructions are available at crlaurence.com.

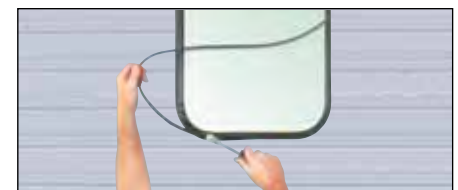

Fabricate Your Own Sliding Windows

- Make Your Own Custom Sliding Glass Window Assemblies
- Perfect for Trucks, Trailers, Tractors, and RV's
- Completely Weatherproof and Rattle Free

Cat. No. AS1656 is the main Gasket used for mounting glass in the body opening. It will hold to the body panel without screws.

Cat. No. AS937 is the Locking Strip used to lock the main Gasket to the body.

Cat. No. AS1524 is a solid rubber Spacer used to fill the gap between the glass run channel where there is no fixed glass.

Cat. No. 8A1 Sliding Glass Channel is placed in the Gasket and used for the sliding glass panel. 96" lengths: Cat. No. 8A196; 60" lengths: Cat. No. 8A160.

Cat. No. 3K196 Glass Edge Weatherstrip mounts on the edge of the fixed glass. This channel seals the space between the two glass panels.

Glass - Use glass 3/16" to 1/4" (5 to 6 mm) thick.



TOP VIEW

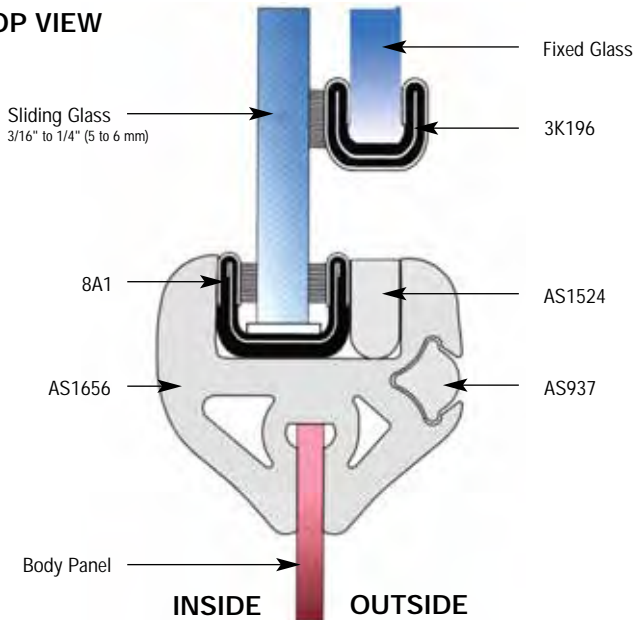

Sliding Window Assembly

GASKET	CAT. NO. AS1656
LOCKING STRIP	CAT. NO. AS937
SPACER	CAT. NO. AS1524
SLIDING GLASS CHANNEL	CAT. NO. 8A196 or 8A160
GLASS EDGE WEATHERSTRIP	CAT. NO. 3K196
GLASS	3/16" to 1/4" (5 to 6 mm) Thick

CRL Sliding Glass Window Handle



- Attractive and Durable Zinc/Steel Finish

For use with the CRL Sliding Window Assembly (above). Slips on glass and holds securely for easy opening and closing of sliding glass panels. Use CRL 33SC Clear Silicone to attach handle to glass.

CAT. NO.	FINISH	SIZE
FP419	Zinc on Steel	2-1/2" x 1/2" Lip

CRL Custom Windows Made To Your Specifications

Our 270,000 sq. ft. window manufacturing plant has the capacity to custom make windows to your exact requirements. We invite bid requests from truck, bus, camper, and heavy equipment manufacturers. Contact our Automotive Technical Sales Department for details. Send e-mail to techsales@crlaurence.com.



CRL One-Piece Self-Sealing Weatherstrip

- Available for Glass Panels from 1/8" to 1/4" Thick
- Sizes for Body Panels from 1/32" to 3/4" Thick
- No Need for a Separate Locking Strip

CRL One-Piece Self-Sealing Weatherstrips are perfect for use on older trucks, off road construction equipment, or farm equipment. CRL has Self-Sealing Weatherstrip in a variety of sizes, so you're assured of finding exactly what you need to perform the best gasket set installation possible. CRL Self-Sealing Weatherstrips are produced from EPDM anti-oxidizing black rubber. This durable material - a terpolymer made from Ethylene, Propylene, and Diene Monomers - is stain, tear, and weather resistant. Inherently impervious to ozone, EPDM has superior resistance to degradation by ultraviolet radiation, and is resistant to both high and low temperature extremes. This makes it ideally suited for outdoor use, and the perfect material for our Self-Sealing Weatherstrips. All sizes are sold in 50 foot (15.2 m) rolls, unless otherwise noted.

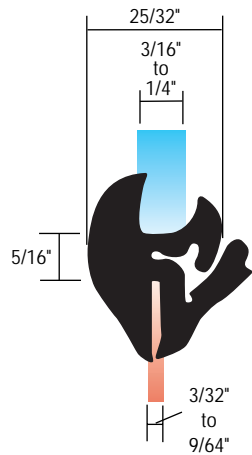
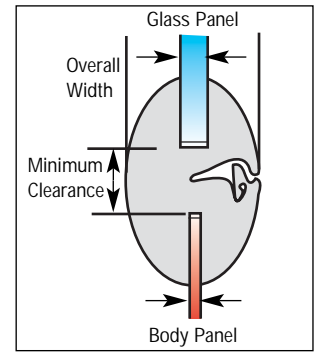

Glass Panel Thickness
3/16" - 1/4" (5 mm - 6 mm)
Body Panel Thickness
3/32" - 9/64" (2.4 mm - 3.6 mm)
Minimum Clearance
5/16" (8 mm)
Overall Width
25/32" (19.8 mm)
Minimum Radius
2-1/2" (63.5 mm)

CAT. NO. AS987

50 Feet (15.2 m) Per Roll

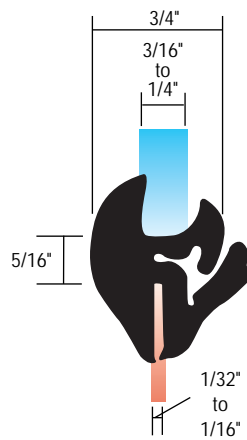

Glass Panel Thickness
3/16" - 1/4" (5 mm - 6 mm)
Body Panel Thickness
1/32" - 1/16" (.8 mm - 1.6 mm)
Minimum Clearance
5/16" (8 mm)
Overall Width
3/4" (19 mm)
Minimum Radius
2-1/2" (63.5 mm)

CAT. NO. AS1522

50 Feet (15.2 m) Per Roll

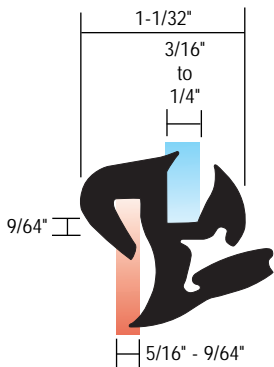

Glass Panel Thickness
3/16" - 1/4" (5 mm - 6 mm)
Body Panel Thickness
5/64" - 9/64" (1.9 mm - 3.6 mm)
Minimum Clearance*
9/64" MAX. (3.6 mm)
Overall Width
1-1/32" (26.2 mm)
Minimum Radius
2" (51 mm)
*On "S" Type Rubber the maximum overlap of glass and body is shown

CAT. NO. AS1660

50 Feet (15.2 m) Per Roll

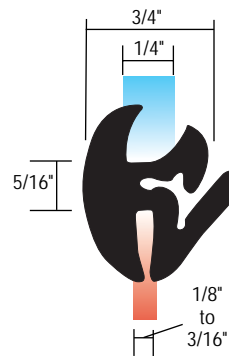

Glass Panel Thickness
1/4" (6 mm)
Body Panel Thickness
1/8" - 3/16" (3 mm - 5 mm)
Minimum Clearance
5/16" (8 mm)
Overall Width
3/4" (19 mm)
Minimum Radius
2-1/2" (63.5 mm)

CAT. NO. 10248

50 Feet (15.2 m) Per Roll

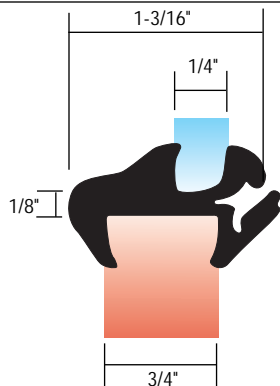

Glass Panel Thickness
1/4" (6 mm)
Body Panel Thickness
3/4" (19 mm)
Minimum Clearance
1/8" (3.2 mm)
Overall Width
1-3/16" (30 mm)
Minimum Radius
2-1/2" (63.5 mm)

CAT. NO. 10249

12 Feet (3.6 m) Per Roll

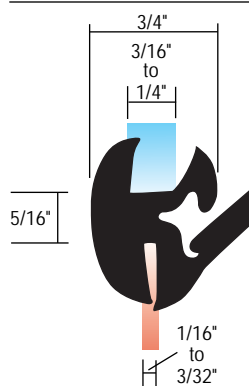

Glass Panel Thickness
3/16" - 1/4" (5 mm - 6 mm)
Body Panel Thickness
1/16" - 3/32" (1.6 mm - 2.4 mm)
Minimum Clearance
5/16" (8 mm)
Overall Width
3/4" (19 mm)
Minimum Radius
2" (51 mm)

CAT. NO. AS1615

50 Feet (15.2 m) Per Roll



CRL One-Piece Self-Sealing Weatherstrip

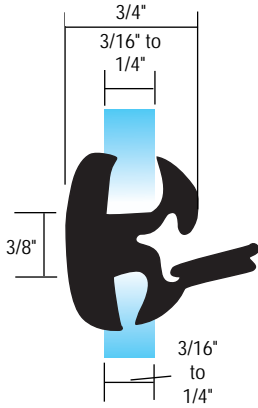

CAT. NO. AS1536

Glass Panel Thickness*
3/16" - 1/4" (5 mm - 6 mm)
* Used as a Division Bar
between two glass panels
Minimum Clearance
3/8" (10 mm)
Overall Width
3/4" (19 mm)
Minimum Radius
3" (76.2 mm)

50 Feet (15.2 m) Per Roll

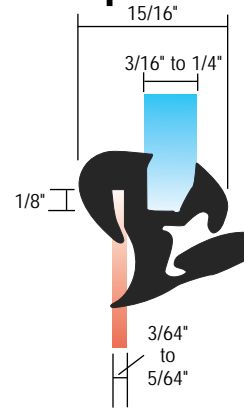

CAT. NO. AS1621

Glass Panel Thickness
3/16" - 1/4" (5 mm - 6 mm)
Body Panel Thickness
3/64" - 5/64" (1.2 mm - 1.9 mm)
Minimum Clearance*
1/8" Max. (3 mm)
Overall Width
15/16" (23.8 mm)
Minimum Radius
2" (51 mm)
*On "S" Type Rubber the maximum
overlap of glass and body is shown.

50 Feet (15.2 m) Per Roll

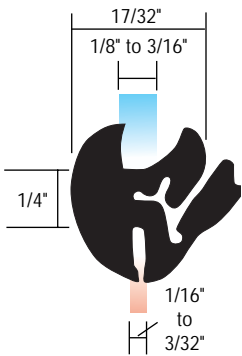

CAT. NO. 10252

Glass Panel Thickness
1/8" - 3/16" (3 mm - 5 mm)
Body Panel Thickness
1/16" - 3/32" (1.6 mm - 2.4 mm)
Minimum Clearance
1/4" (6 mm)
Overall Width
17/32" (13.5 mm)
Minimum Radius
1-1/4" (31.8 mm)

50 Feet (15.2 m) Per Roll

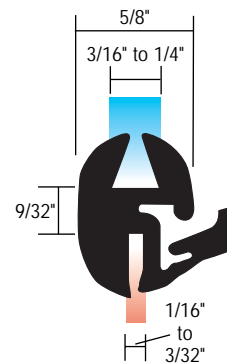

CAT. NO. AS893

Glass Panel Thickness
3/16" - 1/4" (5 mm - 6 mm)
Body Panel Thickness
1/16" - 3/32" (1.6 mm - 2.4 mm)
Minimum Clearance
9/32" (7.1 mm)
Overall Width
5/8" (16 mm)
Minimum Radius
2-1/2" (63.5 mm)

12 Feet (3.6 m) Per Roll

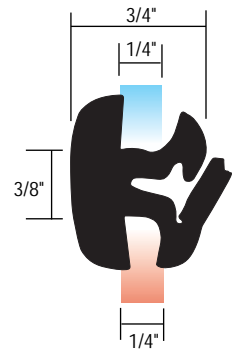

CAT. NO. 10251

Glass Panel Thickness
1/4" (6 mm)
Body Panel Thickness
1/4" (6 mm)
Minimum Clearance
3/8" (10 mm)
Overall Width
3/4" (19 mm)
Minimum Radius
2-1/4" (57 mm)

50 Feet (15.2 m) Per Roll

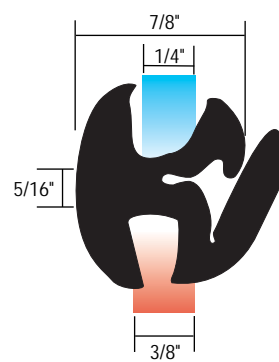

CAT. NO. 10276

Glass Panel Thickness
1/4" (6 mm)
Body Panel Thickness
3/8" (10 mm)
Minimum Clearance
5/16" (8 mm)
Overall Width
7/8" (22.2 mm)
Minimum Radius
4" (102 mm)

50 Feet (15.2 m) Per Roll

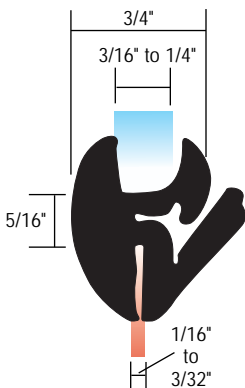

CAT. NO. 10254

Glass Panel Thickness
3/16" - 1/4" (5 mm - 6 mm)
Body Panel Thickness
1/16" - 3/32" (1.6 mm - 2.4 mm)
Minimum Clearance
5/16" (8 mm)
Overall Width
3/4" (19 mm)
Minimum Radius
2" (51 mm)

50 Feet (15.2 m) Per Roll

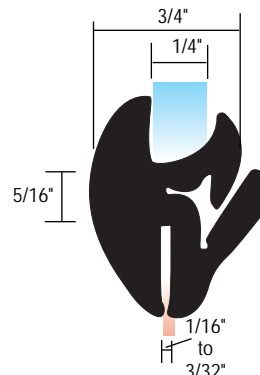

CAT. NO. 10231

Glass Panel Thickness
1/4" (6 mm)
Body Panel Thickness
1/16" - 3/32" (1.6 mm - 2.4 mm)
Minimum Clearance
5/16" (8 mm)
Overall Width
3/4" (19 mm)
Minimum Radius
2-1/2" (63.5 mm)

50 Feet (15.2 m) Per Roll

CRL One-Piece Self-Sealing Weatherstrip

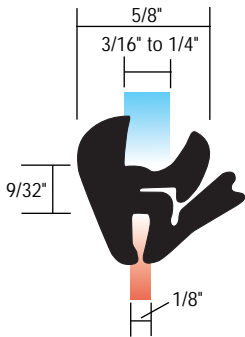

CAT. NO. 10262

Glass Panel Thickness
3/16" - 1/4" (5 mm - 6 mm)
Body Panel Thickness
1/8" (3 mm)
Minimum Clearance
9/32" (7.1 mm)
Overall Width
5/8" (16 mm)
Minimum Radius
2" (51 mm)

50 Feet (15.2 m) Per Roll

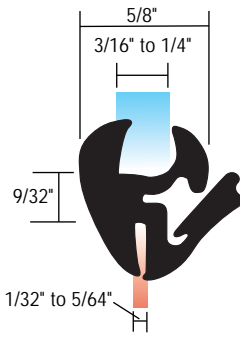

CAT. NO. AS990

Glass Panel Thickness
3/16" - 1/4" (5 mm - 6 mm)
Body Panel Thickness
1/32" - 5/64" (.8 mm - 1.9 mm)
Minimum Clearance
9/32" (7.1 mm)
Overall Width
5/8" (16 mm)
Minimum Radius
1-1/2" (38 mm)

50 Feet (15.2 m) Per Roll

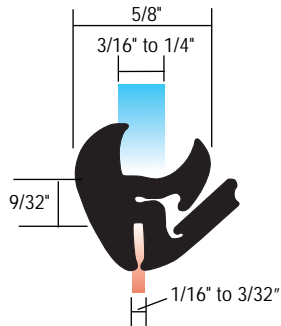

CAT. NO. 10232

Glass Panel Thickness
3/16" - 1/4" (5 mm - 6 mm)
Body Panel Thickness
1/16" - 3/32" (1.6 mm - 2.4 mm)
Minimum Clearance
9/32" (7.1 mm)
Overall Width
5/8" (16 mm)
Minimum Radius
1-1/2" (38 mm)

50 Feet (15.2 m) Per Roll

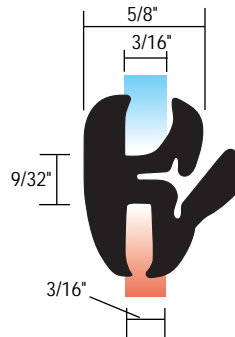

CAT. NO. 10257

Glass Panel Thickness
3/16" (5 mm)
Body Panel Thickness
3/16" (5 mm)
Minimum Clearance
9/32" (7.1 mm)
Overall Width
5/8" (16 mm)
Minimum Radius
2-1/2" (63.5 mm)

50 Feet (15.2 m) Per Roll

CRL Self-Sealing Weatherstrip Locking Tool

• The Most Popular Tool for One-Piece Self-Sealing Weatherstrip

A special handle and insert tool for installing one-piece self-sealing weatherstrip. Also excellent for installing rubber channels with a lip. Insert tip between the locking lip and its groove. Then, by moving tip along the groove, the rubber lip locks in place. Tips and Handle can be ordered separately, or as the complete tool.

CAT. NO.	DESCRIPTION
LT112	Complete Locking Tool
H1	Handle Only
B1	Bent Tip Only
S1	Straight Tip Only

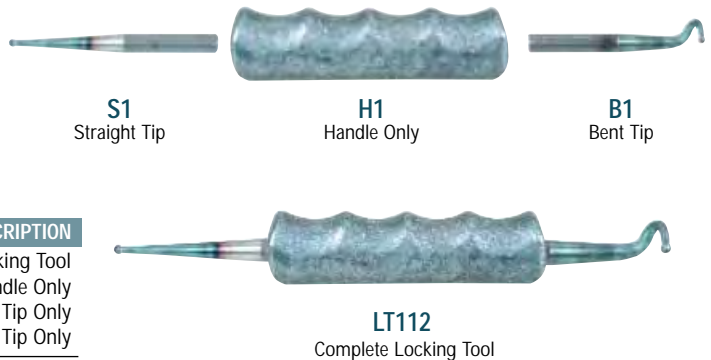

CRL Self-Sealing Weatherstrip Locking Tool

• Steel Roller Reduces Friction



This CRL Self-Sealing Weatherstrip Locking Tool is designed to speed closing of self-sealing windshield and back glass rubber. Steel roller rides along gasket edge to reduce friction.

CAT. NO. CP228

CRL Glas-Slip

• Rubber Lubricant Eases Installation of Rubber Weatherstrips and Gaskets

CRL Glas-Slip is a specially formulated lubricant that makes working with glass and rubber gaskets easy. Also eases the installation of Locking Strips. Apply it with a brush, or spread it on with your fingers.

CAT. NO.	CONTENTS
GS128	1 Gallon (3.785 l)
GS32	1 Quart (.95 l)



CRL Two-Piece Self-Sealing Weatherstrip

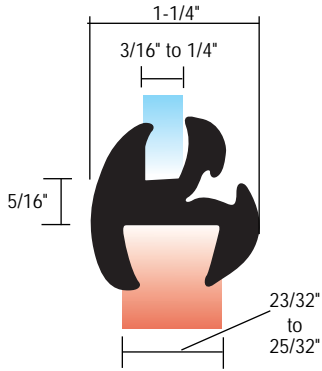

CAT. NO. AS1706

Glass Panel Thickness
3/16" - 1/4" (5 mm - 6 mm)
Body Panel Thickness
23/32" - 25/32" (18.3 mm - 19.8 mm)
Minimum Clearance
5/16" (8 mm)
Overall Width
1-1/4" (31.7 mm)
Minimum Radius
3" (76.2 mm)
Locking Strip
Cat. No. AS937
Locking Strip Tool
Cat. No. CP772095 or CP293

50 Feet (15.2 m) Per Roll

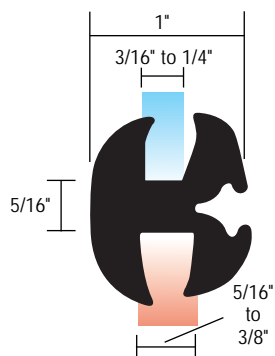

CAT. NO. AS1708

Glass Panel Thickness
3/16" - 1/4" (5 mm - 6 mm)
Body Panel Thickness
5/16" - 3/8" (8 mm - 10 mm)
Minimum Clearance
5/16" (8 mm)
Overall Width
1" (25.4 mm)
Minimum Radius
2-1/2" (63.5 mm)
Locking Strip
Cat. No. AS937
Locking Strip Tool
Cat. No. CP772095 or CP293

50 Feet (15.2 m) Per Roll

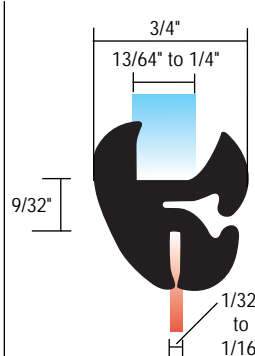

CAT. NO. AS1035

Glass Panel Thickness
13/64" - 1/4" (5.2 mm - 6 mm)
Body Panel Thickness
1/32" - 1/16" (.8 mm - 1.6 mm)
Minimum Clearance
9/32" (7.1 mm)
Overall Width
3/4" (19 mm)
Minimum Radius
2" (51 mm)
Locking Strip
Cat. No. AS937
Locking Strip Tool
Cat. No. CP772095 or CP293

50 Feet (15.2 m) Per Roll

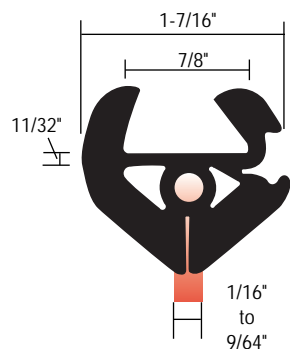

CAT. NO. AS1656

Glass Panel Thickness
7/8" (22 mm) with channel
Body Panel Thickness
1/16" - 9/64" (1.6 mm - 3.6 mm)
Minimum Clearance
11/32" (8.7 mm)
Overall Width
1-7/16" (36.3 mm)
Minimum Radius
4" (102 mm)
Locking Strip
Cat. No. AS937
Locking Strip Tool
Cat. No. CP772095 or CP293

50 Feet (15.2 m) Per Roll

CRL Rubber Spacer

For Use with Cat. No. AS1656 Two-Piece Weatherstrip

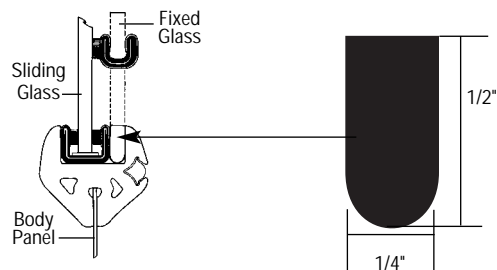

CAT. NO. AS1524

50 Feet (15.2 m) Per Roll

CRL Locking Strip for Two-Piece Weatherstrip

- Install with Cat. No. CP772095, CP293, CP303 or CP304 Tools

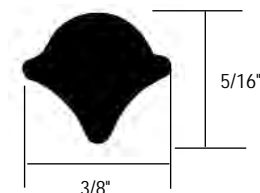

CAT. NO. AS937
50 Feet (15.2 m) Per Roll

- Install with Cat. No. CP221 or CP220 Tools

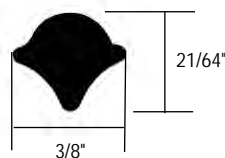

CAT. NO. AS789
50 Feet (15.2 m) Per Roll

- Install with Cat. No. CP663057 Tool

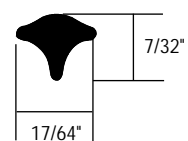

CAT. NO. AS1101
50 Feet (15.2 m) Per Roll



CRL Two-Piece Self-Sealing Weatherstrip

- CRL's Complete Line of Weatherstrips Allow You to Install Glass in a Variety of Applications
- Tight Fitting and Easy-to-Install Design Provides an Efficient Weather Seal

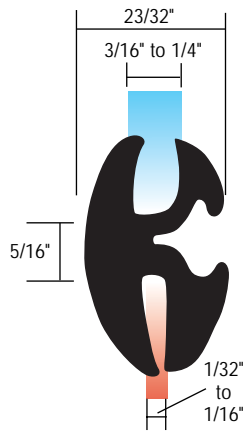

CAT. NO. AS1216

Glass Panel Thickness
3/16" - 1/4" (5 mm - 6 mm)
Body Panel Thickness
1/32" - 1/16" (.8 mm - 1.6 mm)
Minimum Clearance
5/16" (8 mm)
Overall Width
23/32" (18.3 mm)
Minimum Radius
2-1/2" (63.5 mm)
Locking Strip
Cat. No. AS937
Locking Strip Tool
Cat. No. CP772095 or CP293

50 Feet (15.2 m) Per Roll

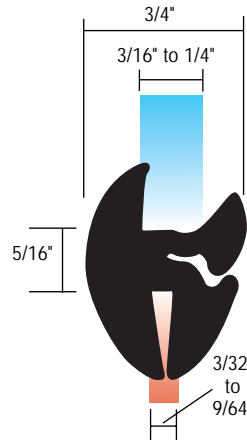

CAT. NO. AS1179

Glass Panel Thickness
3/16" - 1/4" (5 mm - 6 mm)
Body Panel Thickness
3/32" - 9/64" (2.4 mm - 3.6 mm)
Minimum Clearance
5/16" (8 mm)
Overall Width
3/4" (19 mm)
Minimum Radius
2-1/2" (63.5 mm)
Locking Strip
Cat. No. AS937
Locking Strip Tool
Cat. No. CP772095 or CP293

50 Feet (15.2 m) Per Roll

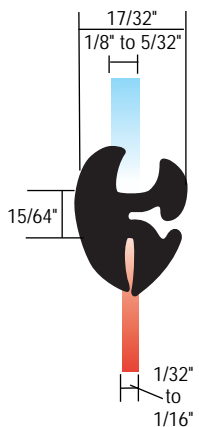

CAT. NO. AS1475

Glass Panel Thickness
1/8" - 5/32" (3.2 mm - 4 mm)
Body Panel Thickness
1/32" - 1/16" (.8 mm - 1.6 mm)
Minimum Clearance
15/64" (6 mm)
Overall Width
17/32" (13.5 mm)
Minimum Radius
2" (51 mm)
Locking Strip
Cat. No. AS1101
Locking Strip Tool
Cat. No. CP221

50 Feet (15.2 m) Per Roll

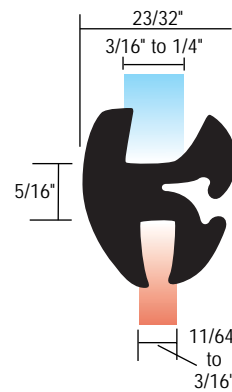

CAT. NO. AS1456

Glass Panel Thickness
3/16" - 1/4" (5 mm - 6 mm)
Body Panel Thickness
11/64" - 3/16" (4.4 mm - 5 mm)
Minimum Clearance
5/16" (8 mm)
Overall Width
23/32" (18.3 mm)
Minimum Radius
2-1/2" (63.5 mm)
Locking Strip
Cat. No. AS937
Locking Strip Tool
Cat. No. CP772095 or CP293

50 Feet (15.2 m) Per Roll

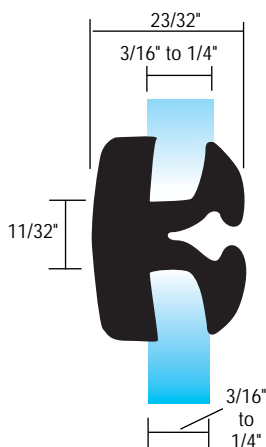

CAT. NO. AS1488

Glass Panel Thickness*
3/16" - 1/4" (5 mm - 6 mm)
* Used as a Division Bar
between two glass panels
Minimum Clearance
11/32" (8.7 mm)
Overall Width
23/32" (18.3 mm)
Minimum Radius
3" (76.2 mm)
Locking Strip
Cat. No. AS937
Locking Strip Tool
Cat. No. CP772095 or CP293

50 Feet (15.2 m) Per Roll

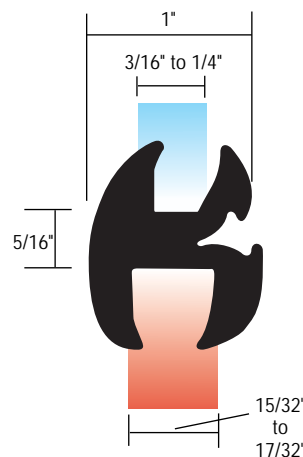

CAT. NO. AS1707

Glass Panel Thickness
3/16" - 1/4" (5 mm - 6 mm)
Body Panel Thickness
15/32" - 17/32" (11.9 mm - 13.5 mm)
Minimum Clearance
5/16" (8 mm)
Overall Width
1" (25.4 mm)
Minimum Radius
2-1/2" (63.5 mm)
Locking Strip
Cat. No. AS937
Locking Strip Tool
Cat. No. CP772095 or CP293

50 Feet (15.2 m) Per Roll

CRL Locking Strips for Self-Sealing Weatherstrip

Diagrams Enlarged to Show Detail

CRL Locking Strip

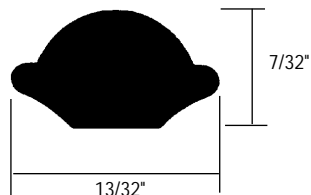

- Chrome Locking Strip for Ford Two-Piece Weatherstrip
- Install with Cat. No. CP293, CP303 or CP304 Tools

CAT. NO.	ROLL SIZE
713080	50 Feet (15.2 m)
75000723	200 Feet (61 m)

CRL Locking Strip

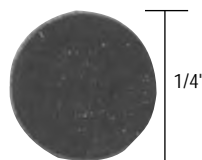

- Round Locking Strip for 1969-1993 Dodge Truck and Van Windshield Weatherstrip
- Install with Cat. No. CP772100 Tool

CAT. NO.	ROLL SIZE
WLS900	16.75 Feet (5.1 m)
14RD	100 Feet (30.4 m)

CRL Locking Strip



- Black Locking Strip for 1973-1990 Chevy/GMC Truck and Blazer Windshield Weatherstrip
- Install with Cat. No. CP732085 Tool

CAT. NO.	ROLL SIZE
WLS466	16 Feet (4.9 m)
WLS466R100	100 Feet (30.4 m)

CRL Locking Strip

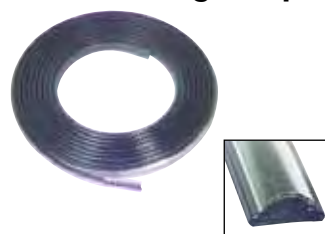

- Chrome Locking Strip for 1973 - 1990 Chevy/GMC Truck Windshield Weatherstrip
- Install with Cat. No. CP732085 Tool

CAT. NO.	ROLL SIZE
WLS848	16 Feet (4.9 m)
WLS848R100	100 Feet (30.4 m)

CRL Locking Strip

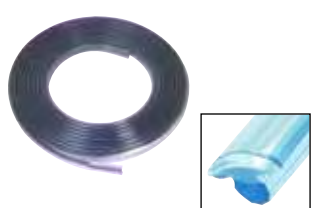

- Chrome Locking Strip for 1990-1993 Dodge Truck and Van Weatherstrip
- Install with Cat. No. CP842103 Tool

CAT. NO.	ROLL SIZE
WLS913	16.75 Feet (5.1 m)

CRL Locking Strip



- Chrome Locking Strip for 1964 - 1989 Volkswagen OEM Windshield Gasket
- Install with Cat. No. CP842103 Tool

CAT. NO.	ROLL SIZE
WLS4165	14.25 Feet (4.3 m)

CRL Multi-Cutter

- Markings for 45, 60, 75, and 90 Degree Cuts on Gaskets and Weatherstrips

The CRL Multi-Cutter is great for cutting PVC strips, rubber gaskets, molding and weatherstrip. Simply align the material to be cut with the desired angle line on the tool's platform and you have a 90°, 75°, 60° or 45° miter cut every time. The cutter is made of high quality steel with vinyl hand grips, which allow for comfort when cutting. Includes five spare blades. Uses CRL Cat. No. 1992C Heavy-Duty Utility Knife Blades.



CAT. NO.	DESCRIPTION
MC80	Multi-Cutter
1992C	100 Utility Knife Blades

CRL Rubber Gasket Cleaning Tool

- Cleans Glass Chips from Gasket Channel

Cleaning broken glass chips from rubber gaskets has never been easy, but it can be with the CRL Rubber Gasket Cleaning Tool. As you pull the tool through the glass channel it cleans out old glass chips and sealant in one easy motion. The tip is specially shaped so it won't tear the gasket. The large handle assures a firm grip while keeping your hands clear of the glass.



CAT. NO. RGC751

CRL Locking Strip Tools

Insert Eyes are Shown Approximately Actual Size

CRL Swivel Tip Locking Strip Tool

- Tips Swivel 90 Degrees
- Comes with Two Double-Ended Tips

The unique design of our Swivel Tip Locking Strip Tool allows the tip to swivel 90° in either direction to work where others will not. This feature provides the easiest way around corners and under roof overhangs. Just select the tip with the opening that most closely fits your locking strip and then feed into the eyelet.



CAT. NO. L47000
Complete Swivel Tip Locking Strip Tool



CAT. NO. L47030
Replacement Dodge Tip



CAT. NO. L47040
Replacement Standard Tip

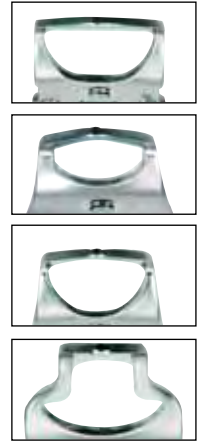

CRL Locking Strip Tools for Large Locking Strips



CAT. NO. CP293 Straight Tip CAT. NO. CP303 Left Handed Tip CAT. NO. CP304 Right Handed Tip

These Locking Strip Tools are used primarily for large windshield gasket locking strips found in trucks, buses, farm and off-road equipment. The tool is available in three models - straight, left, and right hand.

CRL General Purpose Locking Strip Tool

- Fits Our 713080 and AS789 Locking Strips

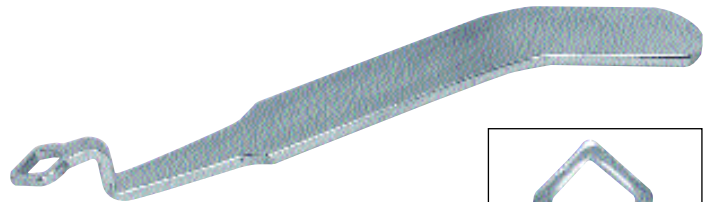

CAT. NO. DT110

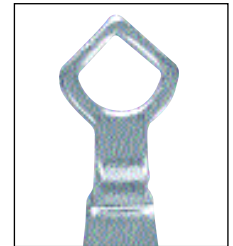

The CRL General Purpose Locking Strip Tool accommodates locking strips up to 7/16" in width. All steel tool is bent for gripping comfort.

CRL Locking Strip Tools for GM, Chrysler and Many Imports

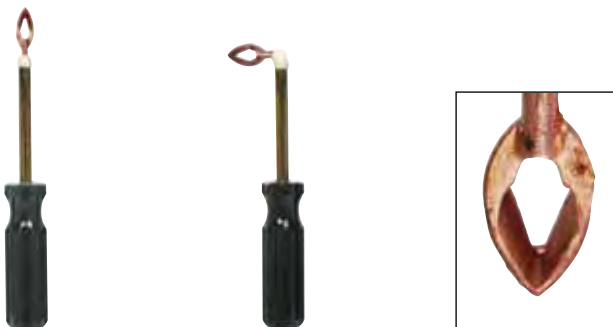

CAT. NO. CP221 Straight Tip CAT. NO. CP220 Left Handed Tip

These popular Locking Strip Tools are used with the locking strips found in many General Motors, Chrysler, and import vehicles. They are available in two models - straight and left hand.

CRL GM Truck Locking Strip Tool

- Fits Wide Locking Strips



CAT. NO. DT161

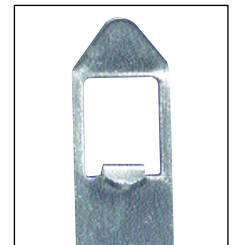

This CRL GM Truck Locking Strip Tool was produced for use with the wide key rubber gasket that comes as standard equipment on all 1973 through 1987 GMC and Chevrolet back glass panels.



CRL Locking Strip Tools

Insert Eyes are Shown Approximately Actual Size

CRL Heavy-Duty Stainless Steel Locking Strip Tool

This CRL Heavy-Duty Locking Strip Tool was designed for use with the wide locking strips used on Dodge, Ford, GM, and other trucks and vans. The tool is constructed of stainless steel to provide years of service.

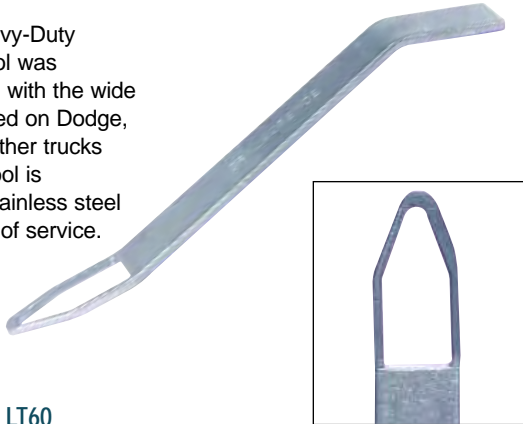

CAT. NO. LT60

CRL Large Eyed Locking Strip Tool

- Fits Cat. No. AS937 Locking Strip

This CRL Locking Strip Tool was designed for use on the locking strips used in Chevrolet trucks and vans, as well as various models of International Harvester vehicles.



CAT. NO. CP772095

CRL Small Eyed Locking Strip Tool

The CRL Small Eyed Locking Strip Insert Tool works great for replacing gaskets on the door inspection panel on GMC and Chevrolet trucks.



CAT. NO. CP663057

CRL Chrysler Locking Strip Tool

Traditionally one of our top sellers, this CRL Chrysler Locking Strip Tool fits most Chrysler cars and trucks that use a locking strip.

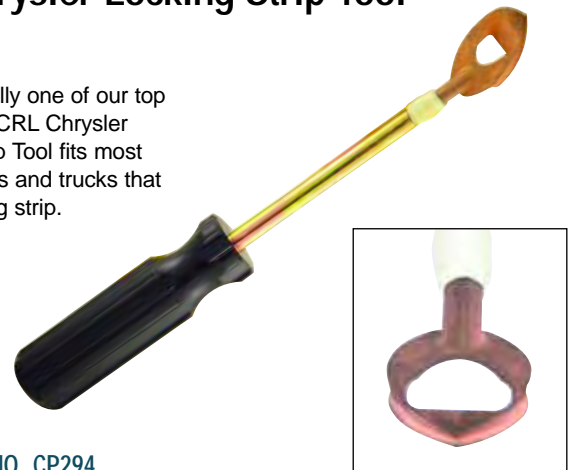

CAT. NO. CP294

CRL Dodge Van Locking Strip Tool

- Fits Our WLS913 and WLS4165 Locking Strips

Specially shaped eye in tool installs our Cat. No. WLS913 T-Shaped Locking Strips used in full size Chrysler/Dodge vans, as well as our Cat. No. WLS4165 Chrome Locking Strip for Volkswagens.



CAT. NO. CP842103

CRL Dodge Van Locking Strip Tool

- Fits Our 14RD and WLS900 Locking Strips

This Locking Strip Tool is designed for use on the locking strips of 1969-1993 Dodge trucks and vans.



CAT. NO. CP772100

CRL Locking Strip Tools

CRL GM Large Eye Locking Strip Tool

- Fits Our WLS848 and WLS466 Locking Strips

The CRL GM Large Eye Locking Strip Tool is for use on all Chevy/GMC Trucks, full size Blazers, and Chevettes that use an inlaid rubber type locking strip, such as our WLS848 or WLS466.



CAT. NO. CP732085

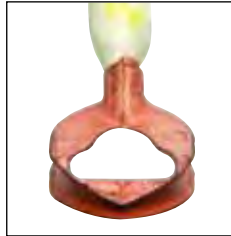

CRL Chevette Locking Strip Tool

- Fits Our Cat. No. AS937 Locking Strip

Use the CRL Chevette Locking Strip Tool on the windshield and rear window glass of Chevy Chevettes and Pontiac T1000 models.

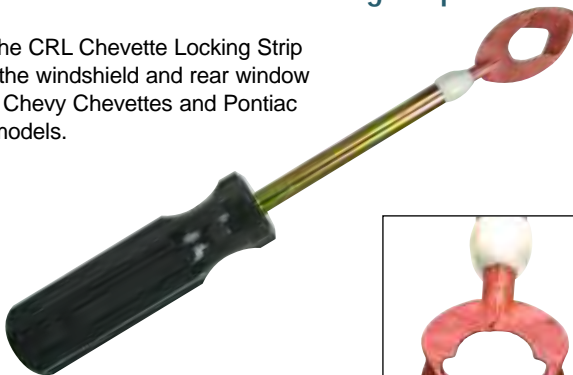

CAT. NO. CP762088



CRL Dodge/Plymouth Locking Strip Tool

This CRL Locking Strip Tool was specially developed and designed to make an easy job of installing the Mylar locking strip which is used in many full size Dodge and Plymouth vans, as well as Dodge Omni and Plymouth Horizon cars. It features a comfortable, screwdriver type handle.



CAT. NO. RM730



Insert Eyes are Shown Approximately Actual Size

CRL General Purpose Gasket Installation Tool

- Also Commonly Known as a 'Hook' Tool



CAT. NO. CP253

The CRL 'Hook' Tool is the most popular tool for working with gasket set glass. Most professionals wouldn't get caught without one because it is so versatile. Not only is it great for gasket work, but you can also use it for cleaning glass chips out of gasket and door glass channels, 'unlocking' one-piece weatherstrips, or for pulling cotter pins.

CRL Bent Point Hook Tool



CAT. NO. CP238

This CRL Bent Point Hook Tool is built without the traditional offset bend found in standard hook tools such as our CP253. Designed to ease the installation of rubber windshield and back glass gaskets over pinchweld in the body opening.

CRL Windshield Stick Setting Tools



CAT. NO. CRL216
Tapered Tip on Both Ends
Overall Length: 7-5/8" (19.5 mm)



CAT. NO. CRL220
Chisel Tip on One End, Tapered Tip on the Other
Overall Length: 7-1/2" (19.2 mm)

CRL Windshield Stick Holder new

- Comfortable Grip for CRL216 and CRL220 Windshield Sticks



Stick Not Included

CAT. NO. CRL216H



CRL Trim Seal®

- Flexible Trim with Seal
- Applies to Flanges
- Multiple Applications

CRL Trim-Seal® is a flexible, decorative edge trim that attaches to an edge without glue or clips. CRL Trim-Seal® is made of a neoprene closed cell sponge seal which is attached to a black leather grain vinyl trim with a segmented steel core. These flexible parts push onto a metal flange to trim the interior and seal the opening.

CRL Trim-Seal® will grip edges from 1/16" to 5/32" (1.6 mm to 3.97 mm) thick, and has multiple uses as a replacement seal.



Individual Metal Clips inside retain permanent grip.

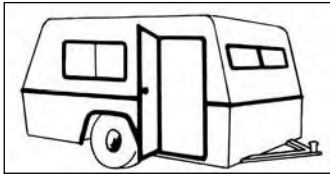

Trim-Seal® is great for use on recreational vehicles and trailers as a gasket around doors and windows.

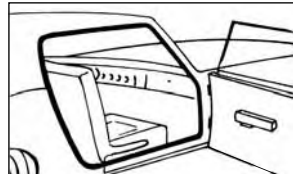

Trim-Seal® has applications in automobiles and a variety of specialty vehicles.

CRL Push-On Trim Seals Sample Chain

- Perfect for Identifying Door Trim or Bulb Seals



CAT. NO. 75002505

This CRL Automotive Push-On Trim Seals Chain contains 44 short sample pieces of our Automotive Bulb Seals and Door Trims. Product matching or choosing an alternative part is easy with this "hands on" sales tool.



CRL Bulb Seal

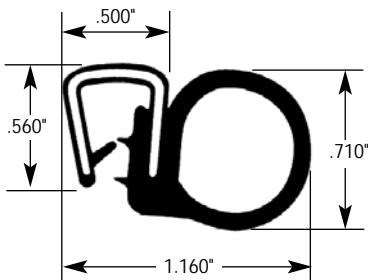

This black color, bulb-shaped neoprene closed-cell sponge seal is used for door and window openings.

CAT. NO.	FLANGE	LENGTH
ST36A	1/16" to 5/32" (1.52 to 3.6 mm)	25 Ft (7.6 m)

CRL Lip Seal

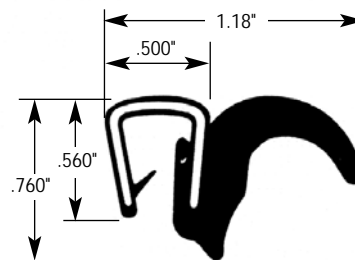

Black color, lip-shaped neoprene closed-cell sponge seal used for door and window openings.

CAT. NO.	FLANGE	LENGTH
ST12A	1/16" to 5/32" (1.52 to 3.6 mm)	25 Ft (7.6 m)

CRL Vertical Wedge Seal

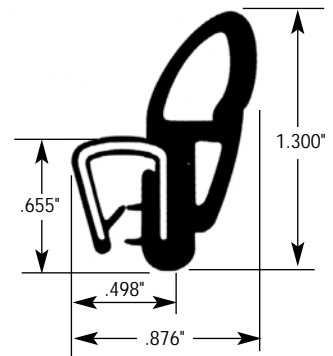

Black color, wedge-shaped seal can be used on door and trunk lip openings.

CAT. NO.	FLANGE	LENGTH
ST29A	1/16" to 5/32" (1.52 to 3.6 mm)	25 Ft (7.6 m)

CRL Bulb Seal

- For 1973 to 1987 Chevy/GMC Trucks, and 1973 to 1991 Blazer, Jimmy, Crew Cab and Suburban

Black color, bulb-shaped seal for door openings.

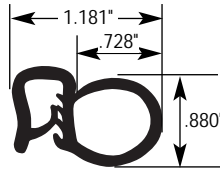

CAT. NO.	FLANGE	LENGTH
DWB111073 ★	.060" to .140" (1.52 to 3.55 mm)	25 Ft (7.6 m)

CRL Vertical Leg Seal

Black color, bulb-shaped seal for large gaps in door or trunk openings.

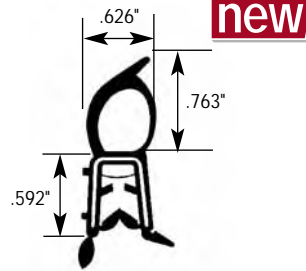

CAT. NO.	FLANGE	LENGTH
75001808 ★	.082" to .200" (2.08 to 5.08 mm)	25 Ft (7.6 m)

CRL Vertical Bulb Seal

Black color, bulb-shaped seal for large gaps in door or trunk openings.

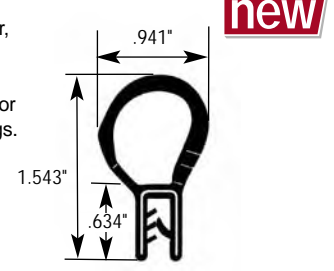

CAT. NO.	FLANGE	LENGTH
75001812 ★	.039" to .118" (1.00 to 3.00 mm)	25 Ft (7.6 m)

CRL Vertical Bulb Seal

Black color, bulb-shaped seal for door or trunk openings.

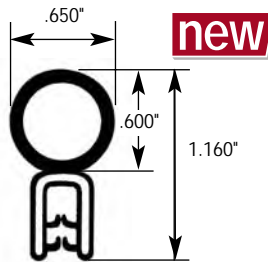

CAT. NO.	FLANGE	LENGTH
75001359 ★	.040" to .070" (1.00 to 1.77 mm)	25 Ft (7.6 m)

CRL Vertical Bulb Seal

Black color, bulb-shaped seal for door or trunk openings.

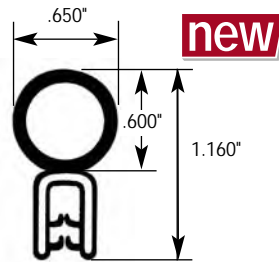

CAT. NO.	FLANGE	LENGTH
75001360 ★	.065" to .095" (1.65 to 2.41 mm)	25 Ft (7.6 m)

CRL Vertical Bulb Seal

Black color, bulb-shaped seal for door or trunk openings.

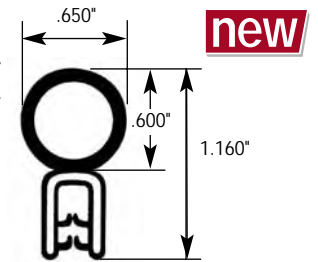

CAT. NO.	FLANGE	LENGTH
75001361 ★	.090" to .120" (2.28 to 3.05 mm)	25 Ft (7.6 m)

CRL Oversize Bulb Seal

Black color, bulb-shaped seal for door or trunk openings.

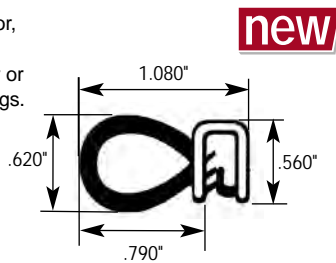

CAT. NO.	FLANGE	LENGTH
75001362 ★	.040" to .070" (1.00 to 1.77 mm)	25 Ft (7.6 m)

CRL Oversize Bulb Seal

Black color, bulb-shaped seal for large gaps in door or trunk openings.

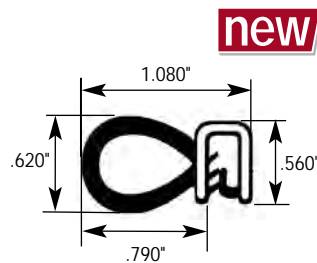

CAT. NO.	FLANGE	LENGTH
75001363 ★	.065" to .095" (1.65 to 2.41 mm)	25 Ft (7.6 m)

CRL Oversize Bulb Seal

Black color, bulb-shaped seal for large gaps in door or trunk openings.

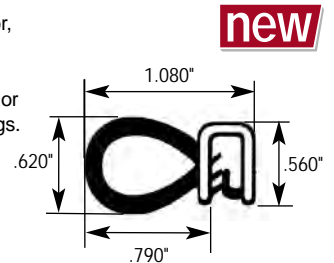

CAT. NO.	FLANGE	LENGTH
75001364 ★	.090" to .120" (2.28 to 3.05 mm)	25 Ft (7.6 m)

CRL Horizontal Wedge Seal

Black color, bulb-shaped seal for door or trunk openings.

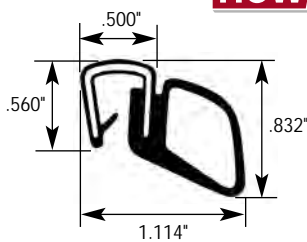

CAT. NO.	FLANGE	LENGTH
75000354 ■	.060" to .140" (1.52 to 3.55 mm)	25 Ft (7.6 m)

CRL Horizontal Bulb Seal

Black color, bulb-shaped seal for large gaps in door or trunk openings.

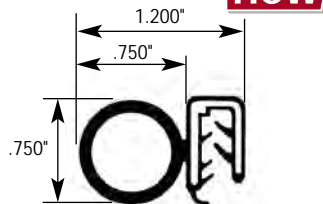

CAT. NO.	FLANGE	LENGTH
75001616 ▲	.110" to .130" (2.80 to 3.30 mm)	25 Ft (7.6 m)

CRL Lip Trim Seal

Black color, bulb-shaped seal for large gaps in door or trunk openings.

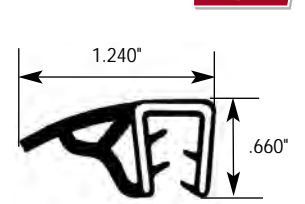

CAT. NO.	FLANGE	LENGTH
75000892 ★	.125" to .250" (3.17 to 6.35 mm)	25 Ft (7.6 m)



CRL Vertical Fin Seal

new

Black color, fin-shaped seal for door or trunk openings.

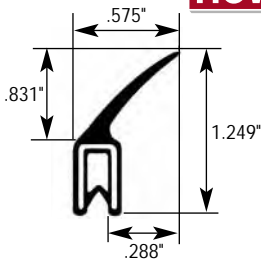

CAT. NO.	FLANGE	LENGTH
75001612 ▲	.079" to .099" (2.00 to 2.51 mm)	82 Ft (25 m)

CRL Vertical Bulb Seal with Lip Seals

new

Black color, bulb-shaped seal for door or trunk openings.

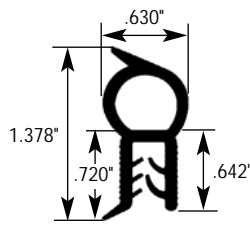

CAT. NO.	FLANGE	LENGTH
75001820 *	.051" to .129" (1.30 to 3.28 mm)	25 Ft (7.6 m)

CRL Vertical Bulb Seal with Lip Seals

new

Black color, bulb-shaped seal for door or trunk openings.

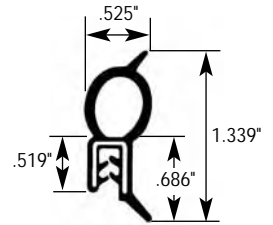

CAT. NO.	FLANGE	LENGTH
75001609 ▲	.060" to .079" (1.52 to 2.00 mm)	82 Ft (25 m)

CRL Vertical Bulb Seal with Lip Seals

new

Black color, bulb-shaped seal for door or trunk openings.

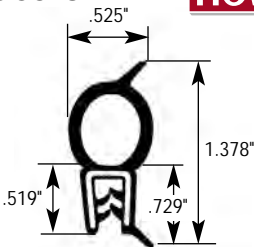

CAT. NO.	FLANGE	LENGTH
75001611 ▲	.060" to .079" (1.52 to 2.00 mm)	82 Ft (25 m)

CRL Multi-Bulb Seal

new

Black color, bulb-shaped seal for door or trunk openings.

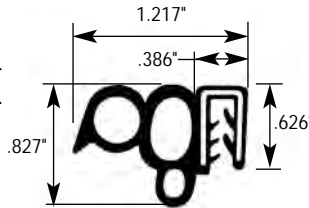

CAT. NO.	FLANGE	LENGTH
75001614 ▲	.071" to .111" (1.80 to 2.82 mm)	82 Ft (25 m)

CRL Vertical 3/8" Bulb Seal

new

Black color, bulb-shaped seal for door or trunk openings.

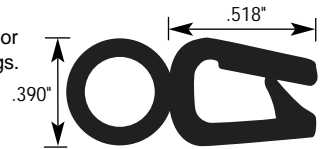

CAT. NO.	FLANGE	LENGTH
75001828 ■	.060" to .170" (1.52 to 4.32 mm)	25 Ft (7.6 m)

CRL Shoulder 3/8" Bulb Seal

new

Black color, bulb-shaped seal for door or trunk openings.

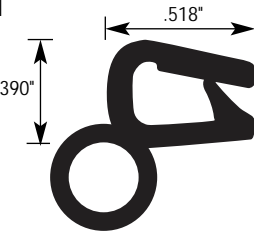

CAT. NO.	FLANGE	LENGTH
75001829 ■	.060" to .170" (1.52 to 4.32 mm)	25 Ft (7.6 m)

CRL Horizontal 3/8" Bulb Seal

new

Black color, bulb-shaped seal for door or trunk openings.

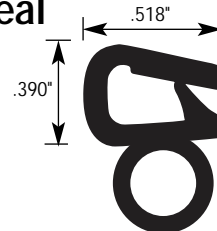

CAT. NO.	FLANGE	LENGTH
75001830 ■	.060" to .170" (1.52 to 4.32 mm)	25 Ft (7.6 m)

CRL Horizontal 3/8" Bulb Seal

new

Black color, bulb-shaped seal for door or trunk openings.

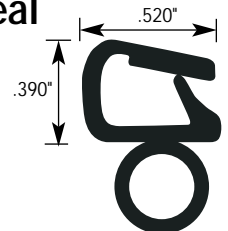

CAT. NO.	FLANGE	LENGTH
75001824 ■	.090" to .190" (2.29 to 4.82 mm)	25 Ft (7.6 m)

CRL Quarter Window Division Bar Weatherstrips

- 1964-1969 GM 2 and 4-Door Hardtops



CAT. NO.	FLANGE	LENGTH
CP682047	Driver Side	16-1/4" (413 mm)
CP682048	Passenger Side	16-1/4" (413 mm)

Composition of Seals

- ▲ Seals with this symbol are Dual Durometer EPDM Rubber Extrusions with a Flexible Segmented Core
- * Seals with this symbol are Dual Durometer Sponge and Solid Rubber with a Flexible Wire Core
- Seals with this symbol are Vinyl and Sponge Rubber with a Flexible Segmented Steel Core

CRL QuickEdge® Trim

- Trims and Protects Raw Edges of Glass, Metal, Fiberglass, Plastic, and Wood
- Universal Application for Vehicle, Furniture, and Display Manufacturers
- Flexible Metal Core Conforms to Curved Edges
- Just Press It On – It Stays On

CRL QuickEdge® is a vinyl (PVC) embossed extrusion with a segmented metal core. Simply push on exposed edges of metal, fiberglass, plastic, plywood, or glass. The steel core provides the strongest and most resilient gripping power available to lock the trim in place.

CRL QuickEdge® Trims are a flexible durometer of 65, except for Standard Double Lip Trims, which are 80 durometer hardness. They are made from environmentally safe vinyl-embossed PVC extrusions with non-cadmium stabilizers. Heat resistance to maximum 150° F (65° C) for continuous use. QuickEdge® Trim is self-extinguishing, and passes Federal Specification FMVSS-302.

Custom Colors: QuickEdge® is also available in white or a number of distinct colors. For pricing and availability on custom colors contact CRL Technical Sales by e-mail at techsales@crlaurence.com.



CRL Standard Double Lip QuickEdge® Trim for 1/32" to 1/8"

Our most popular size grips edges from .032" (.80 mm) to .125" (3.17 mm) thick.

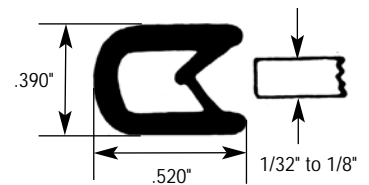

CAT. NO.	COLOR	LENGTH
75000317C	Black Sof-Tone	100 Ft (30.5 m)

CRL QuickEdge® Trim for 3/16" to 1/4"

Grips edges from .135" (3.43 mm) to .250" (6.35 mm) thick.

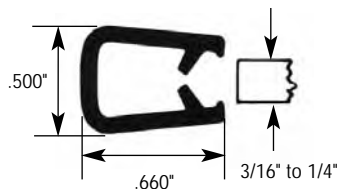

CAT. NO.	COLOR	LENGTH
75000343	Black Sof-Tone	250 Ft (76.2 m)
75343C	Black Sof-Tone	100 Ft (30.5 m)

CRL QuickEdge® Trim for 3/8" to 1/2"

Grips edges from .250" (6.35 mm) to .500" (12.70 mm) thick.

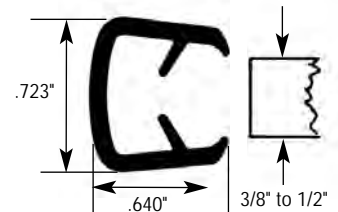

CAT. NO.	COLOR	LENGTH
75000349	Black Sof-Tone	150 Ft (45.7 m)



CRL Mini "Minitrim"

new

Grips edges from
.010" (.25 mm) to
.030" (.76 mm) thick.

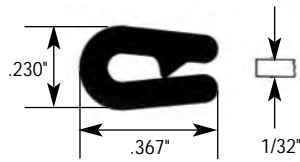

CAT. NO.	COLOR	LENGTH
75001581	Black Sof-Tone	400 Ft (121.9 m)
751581C	Black Sof-Tone	100 Ft (30.5 m)

CRL Mini Trim for 1/32"

new

Grips edges from
.010" (.25 mm) to
.050" (1.27 mm) thick.

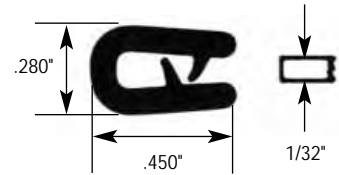

CAT. NO.	COLOR	LENGTH
75000341	Black Sof-Tone	500 Ft (152.4 m)
75341C	Black Sof-Tone	100 Ft (30.5 m)

CRL Standard Single Lip Trim

Grips edges from
.090" (2.29 mm) to
.190" (4.82 mm) thick.

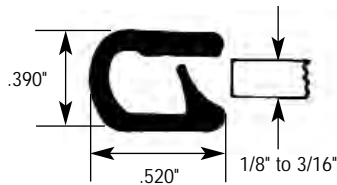

CAT. NO.	COLOR	LENGTH
75000708	Black Sof-Tone	100 Ft (30.5 m)

CRL Pinch Top Single Lip Trim

new

Grips edges from
.060" (1.52 mm) to
.170" (4.32 mm) thick.

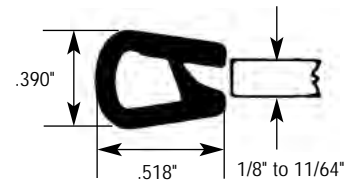

CAT. NO.	COLOR	LENGTH
75000336	Black Basketweave	400 Ft (121.9 m)
75336C	Black Basketweave	100 Ft (30.5 m)

CRL Long Leg Single Lip Trim

new

Grips edges from
.085" (2.16 mm) to
.210" (5.33 mm) thick.

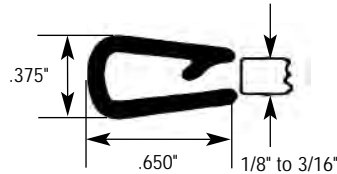

CAT. NO.	COLOR	LENGTH
75000339	Black Sof-Tone	400 Ft (121.9 m)
75339C	Black Sof-Tone	100 Ft (30.5 m)

CRL Long Leg Trim with Chrome Accent

new

Grips edges from
.085" (2.16 mm) to
.210" (5.33 mm) thick.
One leg has a chrome
finish accent pad.

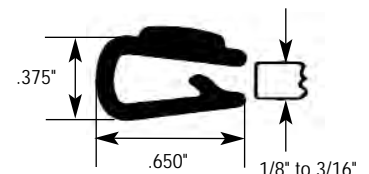

CAT. NO.	COLOR	LENGTH
75000363	Black Sof-Tone	300 Ft (91.4 m)
75363C	Black Sof-Tone	100 Ft (30.5 m)

CRL Safety Orange Single Lip Trim

Grips edges from
.090" (2.29 mm) to
.190" (4.82 mm) thick.

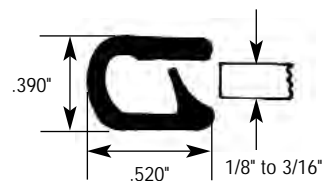

CAT. NO.	COLOR	LENGTH
75000332	Safety Orange	100 Ft (30.5 m)

CRL Safety Yellow Single Lip Trim

new

Grips edges from
.090" (2.29 mm) to
.190" (4.82 mm) thick.

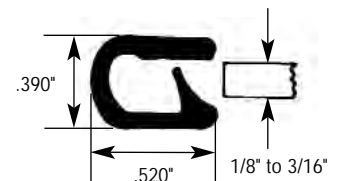

CAT. NO.	COLOR	LENGTH
75000333	Safety Yellow	100 Ft (30.5 m)

CRL Latex Foam Seal Automotive Weatherstripping

• Seal Against Air, Water, Noise, and Dust

Soft latex foam coated with a tough and durable weather resistant skin of neoprene and hypalon rubber, which provides a superior surface compared to other products. Latex Foam Seals take less of a "set", and are more forgiving than sponge seals. The latex foam composition has long been used in luxury automotive applications due to its superior wind, sound, weather, and dust sealing capabilities. These outstanding characteristics are exhibited in both dynamic and static applications. The flexible dense rubber core can be used as a backing strip for fasteners or run into an existing grooved channel. Latex Foam Seals can be installed with a backing tape. Profiles can be looped and attached, or end sealed using a black weatherstrip adhesive/sealer, such as Cat. No. 3M8008 (see page A319). Four profiles of Foam Seals are available in standard 120" (3 meter) lengths.



CAT. NO. 75006000
Large Openings "Dynamic"

Narrow neck design with high profile. Fills larger gap with reduced closing effort. Excellent door seal.

CAT. NO.	LENGTH	QTY/CS
75006000	120" (3 m)	25



CAT. NO. 75006001
Medium Openings "Dynamic"

Wide neck design with medium height. Fills medium gap for tight seal. Excellent door seal.

CAT. NO.	LENGTH	QTY/CS
75006001	120" (3 m)	25

Typical Application

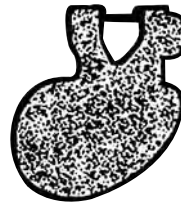

CAT. NO. 75006002
Small Openings Wide Seal "Dynamic"

Wide neck design with integral hinge point and lower offset profile. Excellent door or trunk seal.

CAT. NO.	LENGTH	QTY/CS
75006002	120" (3 m)	25



CAT. NO. 75006003
Compression Seal "Static"

Flexible hollow dense rubber core with tapered 90° arc shape. Excellent sunroof, hatch, or window seal.

CAT. NO.	LENGTH	QTY/CS
75006003	120" (3 m)	25

Minimum order: one length. Sizes can be combined for quantity pricing.

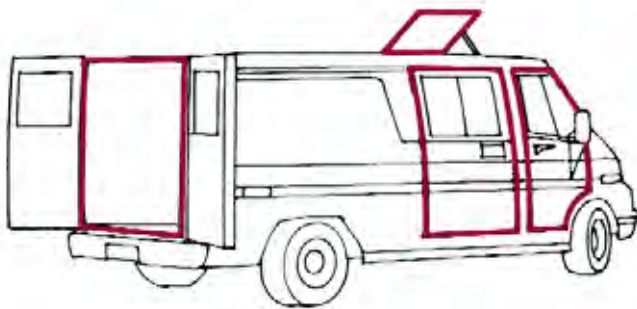

Technical Data

Compression: Ranges from 30% to 70% of original dimension
Set Resistance: Returns to original shape and resists fatigue
Bend: Full 180° span over radius corners with good dimensional stability
Abrasive Resistance: Good resistance to opposing surfaces
Wear: Capable of 50,000 door slam test cycles in OEM tests; provides a low coefficient of friction to mating surfaces
Ozone Resistant: Survives testing in exposure to 50 ppm @ 40°C for 72 hours
Lineal Dimensional Stability: Zero stretch due to dense rubber core; fights elasticity

Closing Force: All profiles designed at less than 15 foot pounds closing force effort
Compatibility: To most paint systems
Flexibility: Excellent performance in cold weather operation; tested to 30°C without loss of coating integrity
Water Resistant: Less than 1% water absorption when immersed for 24 hours
UV Stabilized: Resists deterioration from the sun's ultraviolet rays when fully exposed or under glass

Restorations



Conversions



Recreational Vehicles

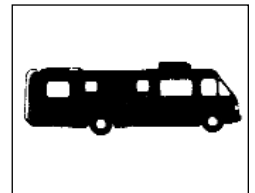

Automotive Parts



Farm Equipment

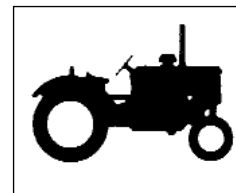

Marine

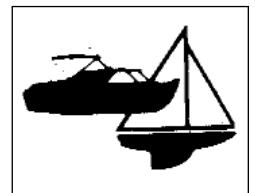

Neoprene Sponge Weatherstrip with Peel-Bak Adhesive

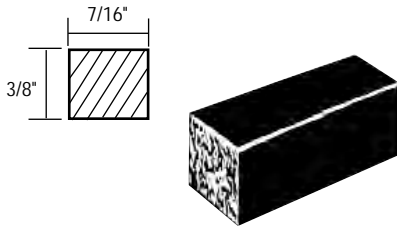

Qty/Roll 50 Ft (15.2 m)
CAT. NO. AV4858

Neoprene Sponge Weatherstrip with Peel-Bak Adhesive

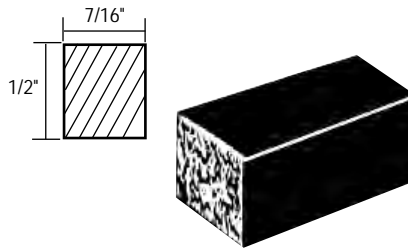

Qty/Roll 50 Ft (15.2 m)
CAT. NO. AV4859

Rectangular Molded Sponge Weatherstrip

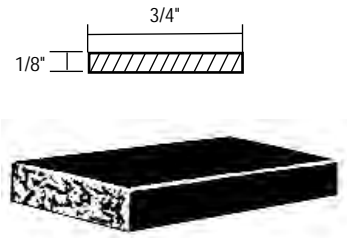

Qty/Roll 25 Ft (7.6 m)
CAT. NO. AV19341

Neoprene Sponge Weatherstrip with Peel-Bak Adhesive

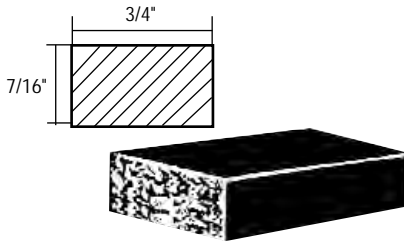

Qty/Roll 50 Ft (15.2 m)
CAT. NO. AV4860

Neoprene Sponge Weatherstrip with Peel-Bak Adhesive

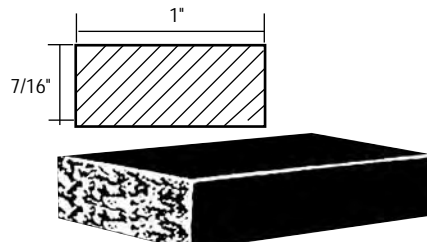

Qty/Roll 50 Ft (15.2 m)
CAT. NO. AV4861

Rectangular Molded Sponge Weatherstrip

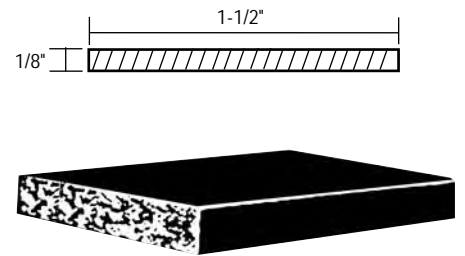

Qty/Roll 25 Ft (7.6 m)
CAT. NO. AV4740

Flexible Foam Filler for Pillars and Door Trim

Round 3/8" Diameter

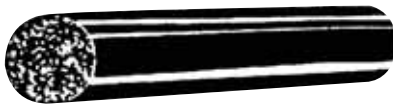

Qty/Roll 50 Ft (15.2 m)
CAT. NO. AV4655

Flexible Foam Filler for Pillars and Door Trim

Round 1/2" Diameter

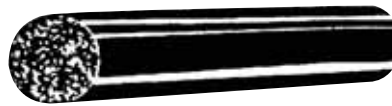

Qty/Roll 50 Ft (15.2 m)
CAT. NO. AV4656

CRL 3M™ Super Weatherstrip Adhesive



- Black Color Blends with Weatherstrips
- Remains Flexible

Strong rubbery 3M™ Super Weatherstrip Adhesive remains flexible. It withstands vibration and extreme temperature variations to secure weatherstripping and gaskets in place. Black color blends with weatherstrips. **Note:** Use Cat. No. 3M8011 weatherstrip adhesive for EPDM weatherstrips.

CAT. NO.	CONTENTS	QTY/CS
3M8008	5 Fl. Oz. (147 ml)	12

Minimum Order: One 5 ounce tube.

Foam Door Weatherstrip

Half Round 3/8" Diameter



Qty/Roll 50 Ft (15.2 m)
CAT. NO. AV4737

Foam Door Weatherstrip

Half Round 1/2" Diameter



Qty/Roll 50 Ft (15.2 m)
CAT. NO. AV4738

Door Flange Weatherstrip

Various Ford Models

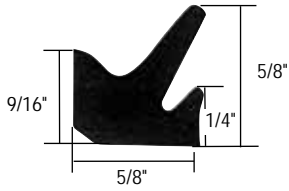

Qty/Roll 50 Ft (15.2 m)
CAT. NO. AV4745

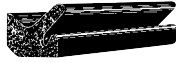

Door Flange Weatherstrip

Various GM Models

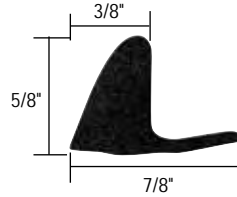

Qty/Roll 50 Ft (15.2 m)
CAT. NO. AV4731



Door Flange Weatherstrip

Various Chrysler Models

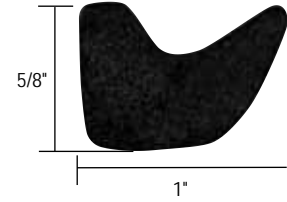

Qty/Roll 50 Ft (15.2 m)
CAT. NO. AV4746



Door Flange Weatherstrip

Various GM Models



Qty/Roll 50 Ft (15.2 m)
CAT. NO. AV4744



Door Flange Weatherstrip

Various GM, Ford, Chrysler Models

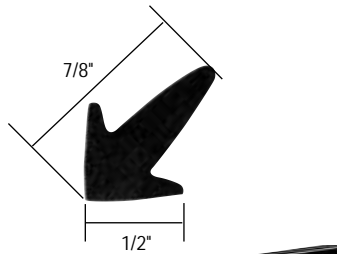

Qty/Roll 50 Ft (15.2 m)
CAT. NO. AV4707



Door Flange Weatherstrip

Various GM Models

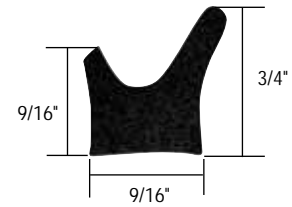

Qty/Roll 50 Ft (15.2 m)
CAT. NO. AV4675



Door Inner Belt Weatherstrip

Various GM, Ford, Chrysler Models

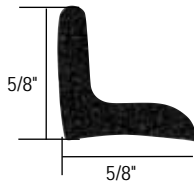

Qty/Roll 50 Ft (15.2 m)
CAT. NO. AV4747



Door Flange Weatherstrip

Various Ford Cars and Dodge Panel Trucks



Qty/Roll 50 Ft (15.2 m)
CAT. NO. SM145



Door Weatherstrip

Chevy Trucks '60-'66

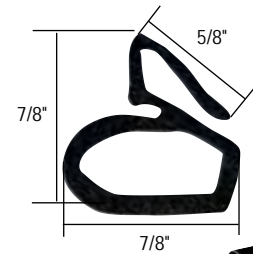

Qty/Roll 55 Ft (16.8 m)
CAT. NO. SM158



Rear Deck Lid Weatherstrip

Various Ford Models

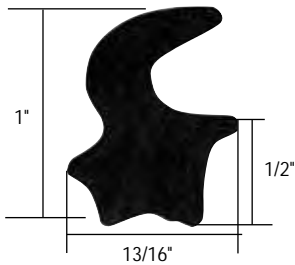

Qty/Roll 50 Ft (15.2 m)
CAT. NO. AV4750



Rear Deck Lid Weatherstrip

Various GM Models

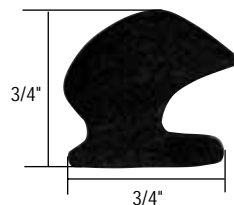

Qty/Roll 50 Ft (15.2 m)
CAT. NO. AV4703

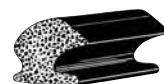

Trunk and Rear Deck Lid Weatherstrip

Various GM Models

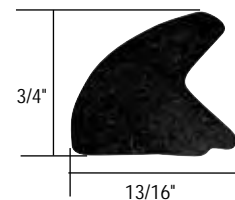

Qty/Roll 50 Ft (15.2 m)
CAT. NO. AV4742



Trunk and Rear Deck Gutter Weatherstrip

Various GM Models



Qty/Roll 50 Ft (15.2 m)
CAT. NO. AV4712



Trunk and Rear Deck Weatherstrip

Various GM Models

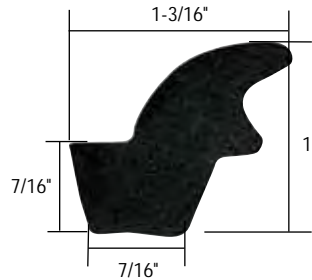

Qty/Roll 50 Ft (15.2 m)
CAT. NO. AV4749



Universal Trunk Seal

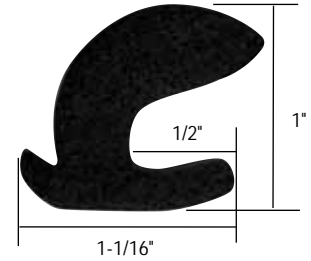

Qty/Roll 35 Ft (10.7 m)
CAT. NO. AV4743



Door Flange Weatherstrip

Ford '53-'56



Qty/Roll 50 Ft (15.2 m)
CAT. NO. AV16891



Roof Rail Weatherstrip

GM '68-'77

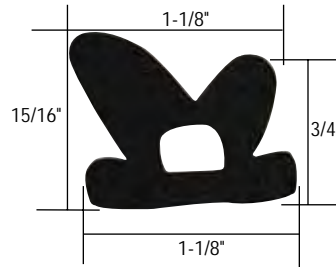

Qty/Roll 25 Ft (7.6 m)
CAT. NO. AV16892



Door Seal Weatherstrip

GM '64-'72

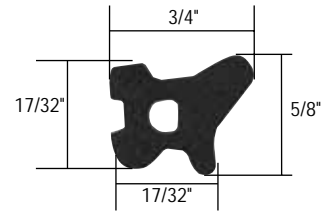

Qty/Roll 50 Ft (15.2 m)
CAT. NO. AV16524



Door Seal Weatherstrip

GM '55-'63

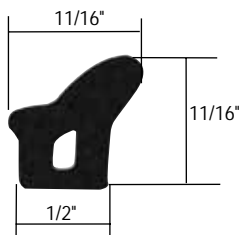

Qty/Roll 50 Ft (15.2 m)
CAT. NO. AV16525



Door Seal Weatherstrip

GM '72+

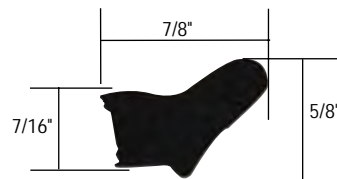

Qty/Roll 50 Ft (15.2 m)
CAT. NO. AV16523



Top of Door Seal

GM Late '70's

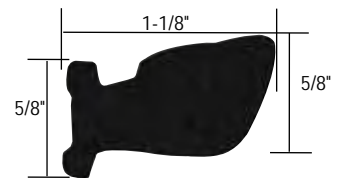

Qty/Roll 25 Ft (7.6 m)
CAT. NO. AV16522



CRL GLASS RUN CHANNELS

For Pricing on CRL Products, Call Toll Free (800) 421-6144, or Visit crlaurence.com

CRL Unbeaded Flexible Glass Run Channels are OEM quality and will provide you with the best results when replacing or repairing damaged or missing channels in older vehicles. All flexible channels have an internal wire loom that is covered by a protective rubber coating for long life. Pile and/or felt linings protect the glass and provide maximum glass cushioning that reduces road noise and allows the glass to operate smoothly. Channels can be fit to tight radiuses by adding relief cuts at the corners. **NOTE: Although CRL states the original applications for these channels, by using the measurements shown you can use these channels on numerous other vehicles.**

10G Flexible*

- Unbeaded
- Pile Lined
- Cloth-Covered
- Used on Chevrolet and GMC Trucks without Framed Glass, 1950-1962

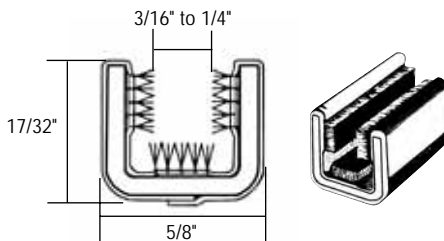

Outside Width5/8" (15.9 mm)
 Inside Width3/16" - 1/4" (4.8 mm - 6 mm)
 Height17/32" (13.5 mm)

CAT. NO.	LENGTH	PER CASE
10G60	60" (1.5 m)	25
10G72	72" (1.8 m)	50
10G96	96" (2.4 m)	25

8A1 Flexible*

- Unbeaded
- Felt and Pile Lined
- Rubber-Covered
- Used on International Diamond-T and Reo Trucks

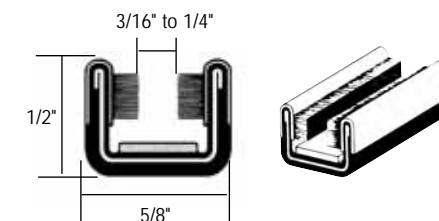

Outside Width5/8" (15.9 mm)
 Inside Width3/16" - 1/4" (4.8 mm - 6 mm)
 Height1/2" (12.7 mm)

CAT. NO.	LENGTH	PER CASE
8A160	60" (1.5 m)	50
8A196	96" (2.4 m)	25

3J4 Flexible

- Unbeaded
- Felt and Pile Lined
- Rubber-Covered
- Flexible Wireloom Inner Structure
- Used on Universal Double Channel for Buses and Trucks

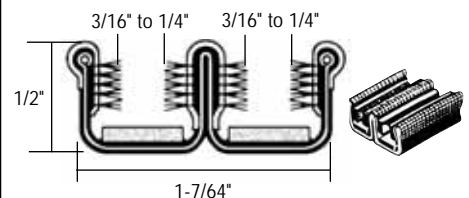

Outside Width1-7/64" (28.1 mm)
 Inside Width3/16" - 1/4" (4.7 mm - 6.4 mm)
 Height1/2" (12.7 mm)

CAT. NO.	LENGTH	PER CASE
3J496	96" (2.4 m)	25

3C1 Flexible

- Unbeaded
- Felt and Pile Lined
- Rubber-Covered
- Used on Willys, Jeep and Diamond-T Trucks '49-'63, Also a Universal Channel for All Trucks

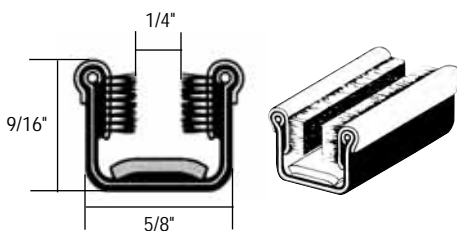

Outside Width5/8" (15.9 mm)
 Inside Width1/4" (6.4 mm)
 Height9/16" (14.3 mm)

CAT. NO.	LENGTH	PER CASE
3C160	60" (1.5 m)	50
3C196	96" (2.4 m)	50

8A2 Flexible

- Unbeaded
- Felt and Pile Lined
- Rubber-Covered
- Used on Jeep, Dodge, and White Trucks

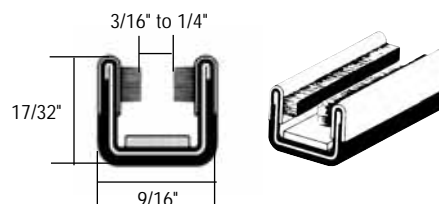

Outside Width9/16" (14.3 mm)
 Inside Width3/16" - 1/4" (4.7 mm - 6.4 mm)
 Height17/32" (13.5 mm)

CAT. NO.	LENGTH	PER CASE
8A260	60" (1.5 m)	50
8A296	96" (2.4 m)	50

10A Flexible

- Unbeaded
- Felt Lined
- Rubber-Covered
- Used on Federal Trucks and Off-Road Equipment

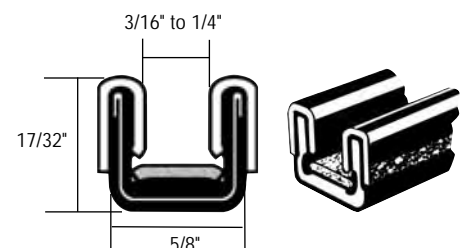

Outside Width5/8" (15.9 mm)
 Inside Width3/16" - 1/4" (4.7 mm - 6.4 mm)
 Height17/32" (13.5 mm)

CAT. NO.	LENGTH	PER CASE
10A60	60" (1.5 m)	50
10A96	96" (2.4 m)	25

*Indicates our best selling numbers: Channels may be combined for quantity pricing. A packing charge will be added to orders of less than 12 combined lengths.



LOG ON TO crlaurence.com FOR BUSINESS-TO-BUSINESS SERVICES

A322 | PHONE (800) 421-6144 | FAX (800) 262-3299 TOLL FREE FROM ANYWHERE IN THE U.S.A. OR CANADA

10E Flexible

- Unbeaded
- Pile Lined
- Cloth-Covered
- Used on Chevrolet and GMC Trucks with Framed Glass, 1950-1963

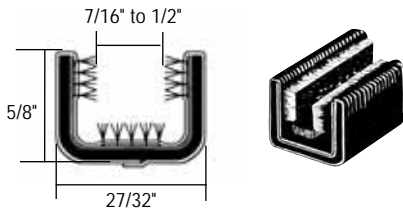

Outside Width27/32" (21.4 mm)
 Inside Width.....7/16" - 1/2" (11 mm - 12.7 mm)
 Height.....5/8" (15.9 mm)

CAT. NO.	LENGTH	PER CASE
10E60	60" (1.5 m)	25
10E72	72" (1.8 m)	50
10E96	96" (2.4 m)	25

5P Flexible

- Unbeaded
- Felt and Pile Lined
- Rubber-Covered
- Used on Diamond-T, International, and Dodge Trucks '49-'66

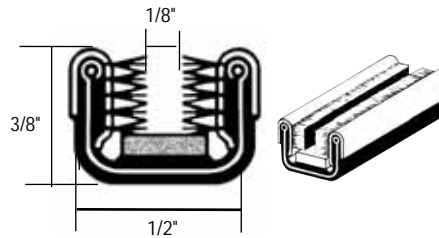

Outside Width1/2" (12.7 mm)
 Inside Width.....3/8" (9.5 mm)
 Height1/2" (12.7 mm)

CAT. NO.	LENGTH	PER CASE
5P96	96" (2.4 m)	50

3A1 Flexible

- Unbeaded
- Felt and Pile Lined
- Rubber-Covered
- Used on Studebaker, White, and Brockway Trucks '52-'67

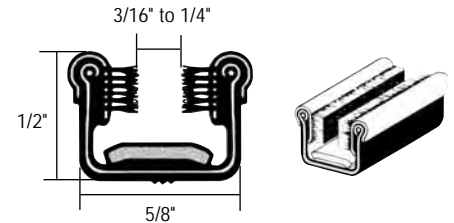

Outside Width5/8" (15.9 mm)
 Inside Width3/16" - 1/4" (4.7 mm - 6.4 mm)
 Height.....1/2" (12.7 mm)

CAT. NO.	LENGTH	PER CASE
3A196	96" (2.4 m)	50

2C Flexible

- Unbeaded
- Felt Lined
- Rubber-Covered
- Willys, Jeep, and Diamond-T Trucks '49-'63. Also a Universal Channel for All Trucks

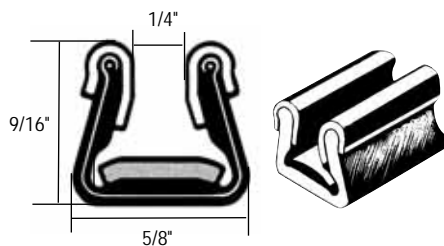

Outside Width.....5/8" (15.9 mm)
 Inside Width1/4" (6.4 mm)
 Height.....9/16" (14.3 mm)

CAT. NO.	LENGTH	PER CASE
2C60	60" (1.5 m)	50
2C96	96" (2.4 m)	50

CRL Automotive Channel Specimen Chain



CAT. NO. 75002500

This CRL Automotive Channel Specimen Chain contains over 50 short pieces of our Automotive Channels, Flocked Rubber Channels, and Belt Weatherstrips. Product matching or choosing an alternative part is easy with this "hands on" sales tools.

Part Matching Service

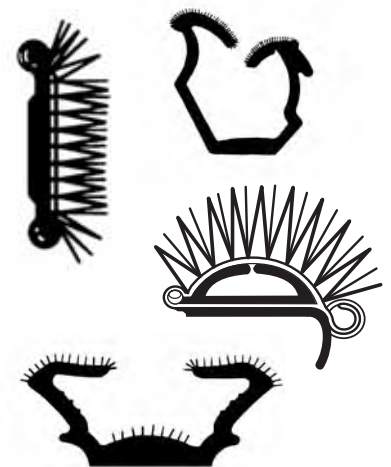

New model cars and trucks are introduced each year with a variety of glass channel and weatherstrips. If you cannot locate the correct part in our catalog we offer a Part Matching Service. Let us know what you are looking for and we'll do our best to recommend the right CRL part to do the job. Contact CRL Automotive Technical Sales by e-mail at techsales@crlaurence.com.

Channels may be combined for quantity pricing. A packing charge will be added to orders of less than 12 combined lengths.



8L Rigid*

- Unbeaded
- Felt and Pile Lined
- Rubber-Covered
- International Trucks Division Bar '50-'63

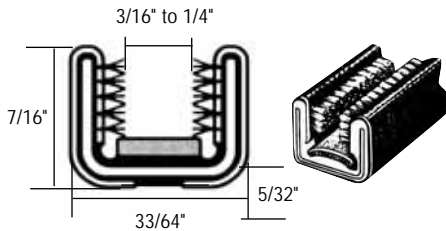

Outside Width33/64" (13.1 mm)
 Inside Width3/16" - 1/4" (4.7 mm - 6.4 mm)
 Height7/16" (11.1 mm)

CAT. NO.	LENGTH	PER CASE
8L96	96" (2.4 m)	50

10K Rigid*

- Unbeaded
- Pile Lined
- Cloth-Covered
- International Trucks '56-'72 and Reo Trucks '55-'71

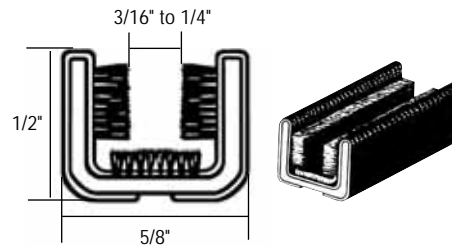

Outside Width5/8" (15.8 mm)
 Inside Width3/16" - 1/4" (4.7 mm - 6.4 mm)
 Height1/2" (12.7 mm)

CAT. NO.	LENGTH	PER CASE
10K96	96" (2.4 m)	50

5V Rigid

- Unbeaded
- Felt and Pile Lined
- Rubber-Covered
- Used on Chevrolet, GMC Trucks Division Bar '51-'54

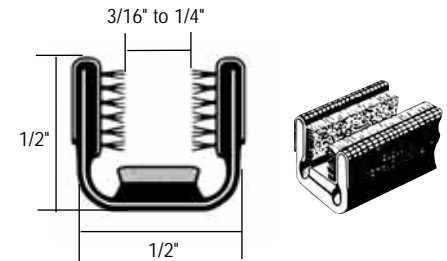

Outside Width1/2" (12.7 mm)
 Inside Width3/16" - 1/4" (4.7 mm - 6.4 mm)
 Height1/2" (12.7 mm)

CAT. NO.	LENGTH	PER CASE
5V36	36" (0.91 m)	50
5V72	72" (1.8 m)	25
5V96	96" (2.4 m)	50

3K1 Rigid

- Unbeaded
- Felt Lined
- Rubber-Covered

Edge Channel for insulation between parallel sliding panels with channel fitted to the edge of one panel.

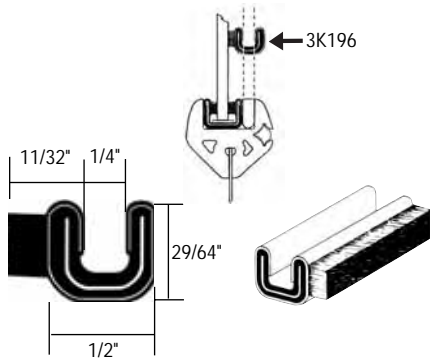

Outside Width1/2" (12.7 mm)
 Inside Width1/4" (6.4 mm)
 Height29/64" (11.5 mm)

CAT. NO.	LENGTH	PER CASE
3K196	96" (2.4 m)	50

5R Rigid

- Unbeaded
- Felt and Pile Lined
- Rubber-Covered
- Used on Checker Taxi and International Trucks '49-'63

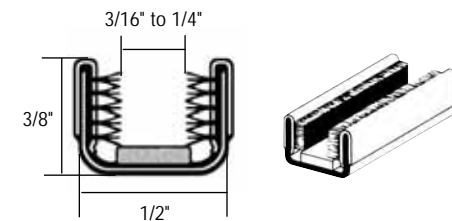

Outside Width1/2" (12.7 mm)
 Inside Width3/16" - 1/4" (4.7 mm - 6.4 mm)
 Height3/8" (9.5 mm)

CAT. NO.	LENGTH	PER CASE
5R96	96" (2.4 m)	50

CRL is constantly adding new products to our product line. If you don't see what you need, log on to crlaurence.com to see our latest additions.



*Indicates our best selling numbers. Channels may be combined for quantity pricing. A packing charge will be added to orders of less than 12 combined lengths.



25JP Rigid

- Unbeaded
- Polypropylene Pile Lining
- Uncovered
- Used on G.M. Division Bar '62-'67, and Chrysler Division Bar '57-'59

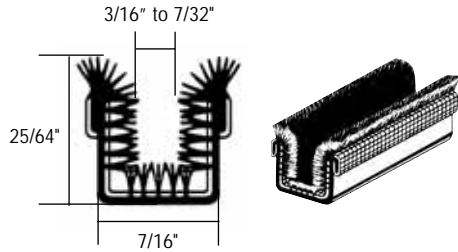

Outside Width3/8" (9.5 mm)
 Inside Width3/16" - 7/32" (4.7 mm - 5.5 mm)
 Height3/8" (9.5 mm)

CAT. NO.	LENGTH	PER CASE
25JP96	96" (2.4 m)	50

5Y1 Rigid

- Unbeaded
- Rubber Impregnated Lining
- Rubber-Covered
- Used on Chrysler Cars 1955-1959

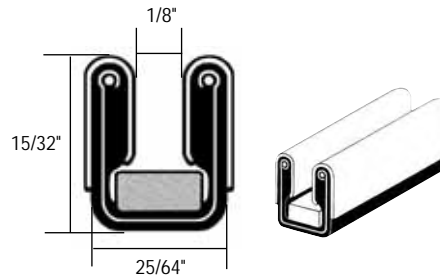

Outside Width25/64" (9.9 mm)
 Inside Width1/8" (3.2 mm)
 Height15/32" (11.09 mm)

CAT. NO.	LENGTH	PER CASE
5Y196	96" (2.4 m)	50

10M Flexible

- Unbeaded
- Pile Lined
- Cloth-Covered
- Used on Chevrolet and GMC Trucks without Framed Glass from 1963-1964

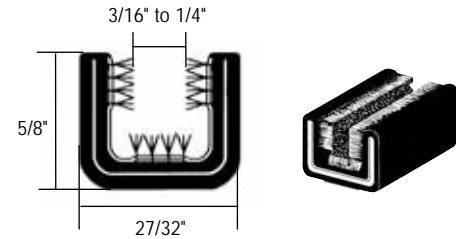

Outside Width27/32" (21.4 mm)
 Inside Width3/16" - 1/4" (4.7 mm - 6.4 mm)
 Height5/8" (15.9 mm)

CAT. NO.	LENGTH	PER CASE
10M60	60" (1.5 m)	25

CRL Beaded Glass Run Channels

CRL Beaded Channels have either a stainless or galvanized-steel bead, which provides extra trim and increases sidewall rigidity. The close-packed wool or polypropylene pile fabric lining gives a heavy cushion and weather-tight fit with minimum friction to glass. Extra long channel life is assured with either a galvanized or rubber-covered steel core. Where used, the rubber-covered steel core gives the utmost protection against corrosion, noise and rattles. **NOTE: Although CRL states the original applications for these channels, by using the measurements shown you can use these channels on numerous other vehicles.**

Y526 Flexible*

- Stainless Steel Bead
- Felt and Pile Lined
- Rubber-Covered
- Used on Many Makes of Cars from 1948-1967

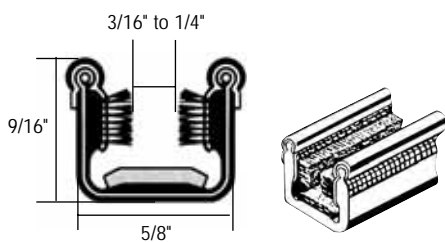

Outside Width5/8" (15.9 mm)
 Inside Width3/16" - 1/4" (4.7 mm - 6.4 mm)
 Height9/16" (14.3 mm)

CAT. NO.	LENGTH	PER CASE
Y52660	60" (1.5 m)	50

Y528 Flexible*

- Stainless Steel Bead
- Pile Lined
- Cloth-Covered
- Universal Channel for Many Makes of Cars from 1948-1967

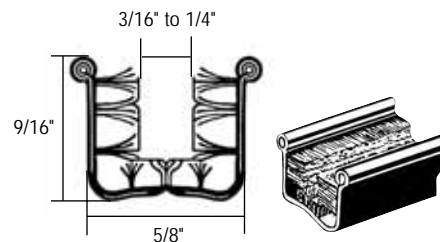

Outside Width5/8" (15.9 mm)
 Inside Width3/16" - 1/4" (4.7 mm - 6.4 mm)
 Height9/16" (14.3 mm)

CAT. NO.	LENGTH	PER CASE
Y52860	60" (1.5 m)	25
Y52872	72" (1.8 m)	25
Y52896	96" (2.4 m)	25

Y620 Flexible

- Stainless Steel Bead
- Pile Lined
- Rubber-Covered
- Used on G.M. and Ford Products that use a Snap-In Type Channel from 1954-1966

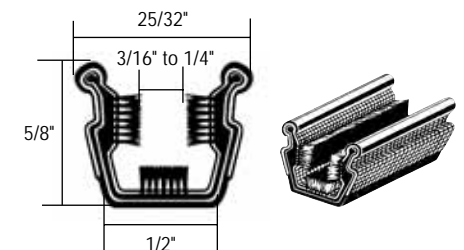

Outside Width1/2" (12.7 mm)
 Inside Width3/16" - 1/4" (4.7 mm - 6.4 mm)
 Height5/8" (15.9 mm)

CAT. NO.	LENGTH	PER CASE
Y62096	96" (2.4 m)	50

*Indicates our best selling numbers. Channels may be combined for quantity pricing. A packing charge will be added to orders of less than 12 combined lengths.

Y630P Flexible

- Stainless Steel Bead
- Pile Lined
- Rubber-Covered
- Used on Many Makes of Cars from '48-'67

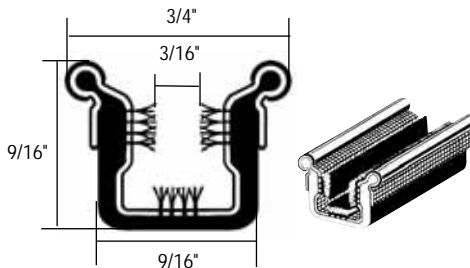

Outside Width (Top)3/4" (19.1 mm)
 Outside Width (Bottom).....9/16" (14.3 mm)
 Inside Width.....3/16" (4.9 mm)
 Height9/16" (14.3 mm)

CAT. NO.	LENGTH	PER CASE
Y630P60	60" (1.5 m)	50
Y630P96	96" (2.4 m)	25

Y619P Rigid*

- Stainless Steel Bead
- Pile Lined
- Uncovered
- Used for Division Bar on Ford Products '57-'67

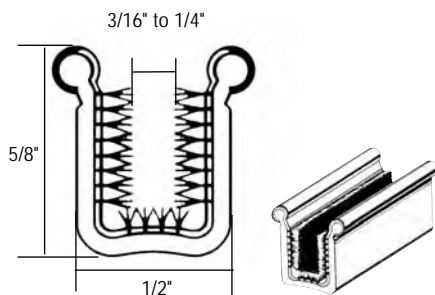

Outside Width1/2" (12.7 mm)
 Inside Width.....3/16" - 1/4" (4.9 mm - 6.4 mm)
 Height5/8" (15.9 mm)

CAT. NO.	LENGTH	PER CASE
Y619P96	96" (2.4 m)	25

Y691P Flexible

- Stainless Steel Bead
- Pile Lined
- Rubber-Covered
- Used for Division Bar on GMC Trucks '55-'62

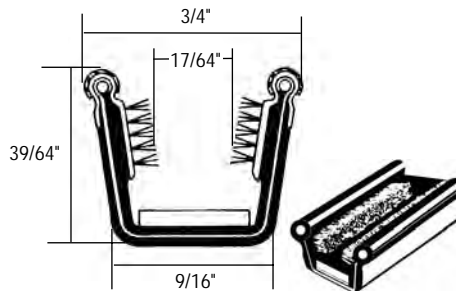

Outside Width (Top)3/4" (19.1 mm)
 Outside Width (Bottom)9/16" (14.3 mm)
 Inside Width17/64" (6.7 mm)
 Height39/64" (15.5 mm)

CAT. NO.	LENGTH	PER CASE
Y691P60	60" (1.5 m)	50

Y658X Rigid*

- Stainless Steel Bead
- Pile Lined
- Uncovered
- Used for Division Bar on Ford, Mercury, and Lincoln '52-'55; Chevrolet and GMC Trucks '64-'67; Dodge Trucks '64-'67

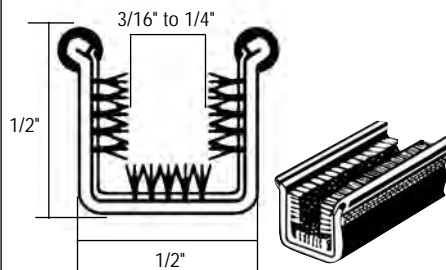

Outside Width.....1/2" (12.7 mm)
 Inside Width.....3/16" - 1/4" (4.8 mm - 6.4 mm)
 Height1/2" (12.7 mm)

CAT. NO.	LENGTH	PER CASE
Y658X72	72" (1.8 m)	25
Y658X96	96" (2.4 m)	25

Technical Assistance



CRL Automotive Technical Sales Representatives are available to answer your application and installation questions regarding windows, sealants, tools, weatherstrips, and fasteners. Contact them at (800) 421-6144 in the U.S., (877) 421-6144 from Canada, or (323) 588-1281 International. Ask for Ext. 7780, or contact them by e-mail techsales@crlaurence.com

Y614 Rigid*

- Stainless Steel Bead
- Pile Lined
- Uncovered
- Used for Upper Division Bar on G.M. Cars from '53-'63

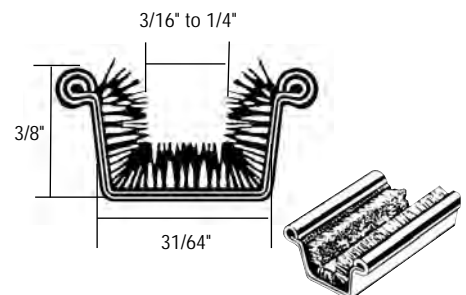

Outside Width31/64" (12.3 mm)
 Inside Width3/16" - 1/4" (4.8 mm - 6.4 mm)
 Height3/8" (9.5 mm)

CAT. NO.	LENGTH	PER CASE
Y61472	72" (1.8 m)	50
Y61496	96" (2.4 m)	50

*Indicates our best selling numbers. Channels may be combined for quantity pricing. A packing charge will be added to orders of less than 12 combined lengths.



Y660X Rigid

- Stainless Steel Wrap
- Pile Lined
- Uncovered
- Used for Division Bar on Ford and Mercury '55-'58; Mack Trucks '59-'62

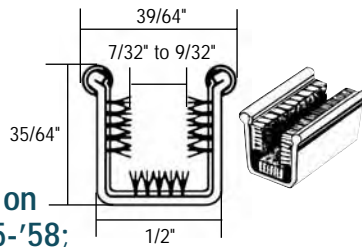

Bottom Width 1/2" (12.7 mm)
 Top Width 39/64" (15.5 mm)
 Inside Width 7/32" - 9/32" (5.5 mm - 7.1 mm)
 Height 35/64" (13.9 mm)

CAT. NO.	LENGTH	PER CASE
Y660X72	72" (1.8 m)	25
Y660X96	96" (2.4 m)	25

Y5632 Rigid

- Galvanized Steel
- Pile Lined
- Uncovered
- Used for Lower Division Bar on G.M. Cars from '53-'63

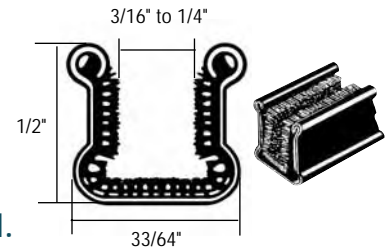

Outside Width 33/64" (13.1 mm)
 Inside Width 3/16" - 1/4" (4.8 mm - 6.4 mm)
 Height 1/2" (12.7 mm)

CAT. NO.	LENGTH	PER CASE
Y563296	96" (2.4 m)	25

CRL Marine Glass Run Channels

CRL Marine Glass Run Channels are designed for use in boats and buses. These channels are available in rigid and flexible configurations. Flexible Marine Glass Run Channel provides the flexibility needed to be used in curved openings. For best appearance, set this channel in a groove. Channels can be fit to tight radiuses by adding relief cuts at the corners. Rigid Marine Glass Run Channels with polished Stainless Steel wrap can be sunk in a groove or surface mounted, and only used in straight edge openings. When using the double channel, use with 16M Edge Channel for the best weathertight results. All channels are pile and/or felt lined to protect the glass. The nylon bottom strip assures easy sliding panels, and provides a quiet and smooth operation.

Y583 Rigid*

- Stainless Steel Wrap
- Pile Lined
- Polished Surface
- Nylon Bottom Strip

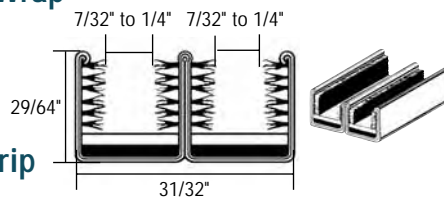

This Polished Double Channel is the most popular marine channel and when used with 16M Edge Channel, the best unit is available. It can be surface mounted or sunk in a groove when used in straight openings.

Outside Width 31/32" (24.6 mm)
 Inside Width 7/32" - 1/4" (5.5 mm - 6.4 mm)
 Height 29/64" (11.5 mm)

CAT. NO.	LENGTH	PER CASE
Y58396	96" (2.4 m)	25

16M Rigid*

- Stainless Steel Wrap
- Pile Wipe
- Polished Surface
- Won't Rust

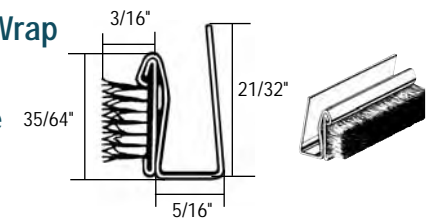

This Edge Channel is used to obtain a positive seal between a stationary panel and a sliding panel, or between two sliding panels. Fits 3/16" to 1/4" glass.

Outside Width 5/16" (4.7 mm)
 Pile Height 3/16" (6.4 mm)
 Leg Height 21/32" (16.7 mm)

CAT. NO.	LENGTH	PER CASE
16M96	96" (2.4 m)	25

Y582 Rigid

- Stainless Steel Wrap
- Pile Lined
- Polished Surface
- Nylon Bottom Strip

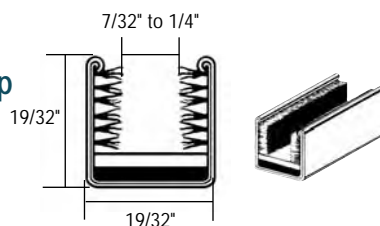

Outside Width 19/32" (15.1 mm)
 Inside Width 7/32" to 1/4" (5.5 mm - 6.4 mm)
 Height 19/32" (15.1 mm)

Polished outside wrap allows this channel to be sunk in a groove or surface mounted. Can only be used in straight edge openings. Nylon bottom assures easy sliding panels.

CAT. NO.	LENGTH	PER CASE
Y58296	96" (2.4 m)	25

Y577 Flexible

- Rubber-Covered
- Pile Lined
- Nylon Bottom Strip

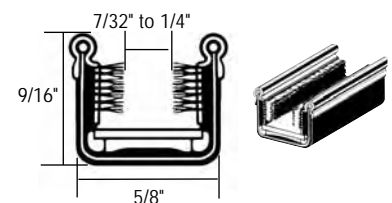

Outside Width 5/8" (15.9 mm)
 Inside Width 7/32" - 1/4" (5.5 mm - 6.4 mm)
 Height 9/16" (14.3 mm)

Designed for sliding windows in boats and buses. Nylon bottom strip assures easy sliding panels. Flexibility allows it to be used in curved openings. For best appearance, set this channel in a groove.

CAT. NO.	LENGTH	PER CASE
Y57796	96" (2.4 m)	25

*Indicates our best selling numbers. Channels may be combined for quantity pricing. A packing charge will be added to orders of less than 12 combined lengths.



CRL Glass Run Channel

- Flexible in All Directions Without Deforming**

The exclusive wire carrier allows use on short radius curves, and will accept sliding glass panels without binding or distorting.

- Economical and Easy to Use**

Available on reels which eliminate scrap from cut lengths. Simplifies storage and inventory.

- Installs Easily**

Unique wire construction simplifies application.

- Guaranteed Long Life**

Woven pile will outwear and outperform any other channel material.

- Replaces Rigid Channels**

New flexible channel will not crush, and easily conforms to all contours.

- Rot, Mildew, and Corrosion Resistant**

Available in 100% black poly-pile with electrogalvanized or stainless steel wire.

CRL Schlegel Flexible Glass Run Channel is an excellent seal for windows in buses, campers, RV's, mobile homes, or any vehicle with irregularly shaped windows. A synthetic polypropylene pile is woven to a non-rust wire carrier backing which is designed to assure proper drainage. This flexible channel always retains its shape when flexed, and won't bunch up or bind sliding windows. It comes in a variety of sizes, and is perfect for both glass and aluminum run channels.



21116181951 Flexible

- For 3/16" (5 mm) Glass**

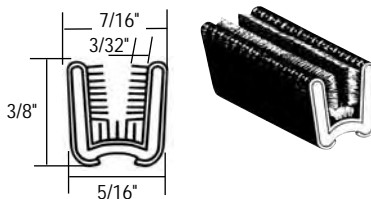

Universal Single Channel

Base Width5/16" (7.9 mm)
Top Width7/16" (11.2 mm)
Height3/8" (9.5 mm)
Pile Height3/32" (2.4 mm)

CAT. NO.	DESCRIPTION
21116181951C	100 Ft. (30 m) Roll
21116181951	500 Ft. (152 m) Roll

21116432061 Flexible

- For 1/4" (6 mm) Glass**

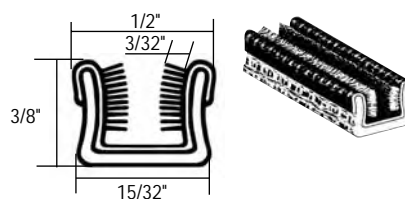

Universal Single Channel

Base Width15/32" (11.9 mm)
Top Width1/2" (12.7 mm)
Height3/8" (9.5 mm)
Pile Height3/32" (2.4 mm)

CAT. NO.	DESCRIPTION
21116432061C	100 Ft. (30 m) Roll
21116432061	500 Ft. (152 m) Roll

21114541901 Flexible

- For 5/16" (8 mm) Glass**

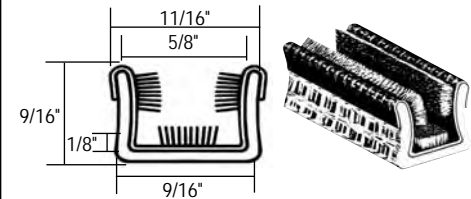

Universal Single Channel

Base Width9/16" (14.2 mm)
Top Width11/16" (17.5 mm)
Height9/16" (14.2 mm)
Pile Height1/8" (3.2 mm)

CAT. NO.	DESCRIPTION
21114541901C	100 Ft. (30 m) Roll
21114541901	300 Ft. (91 m) Roll

21116442081 Flexible

- For 5/16" (8 mm) Glass**

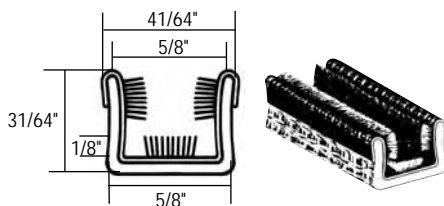

Universal Single Channel

Base Width5/8" (15.8 mm)
Top Width41/64" (16.3 mm)
Height31/64" (12.3 mm)
Pile Height1/8" (3.2 mm)

CAT. NO.	DESCRIPTION
21116442081C	100 Ft. (30 m) Roll
21116442081	300 Ft. (91 m) Roll

21414301911 Flexible

- For 1/4" (6 mm) Glass**

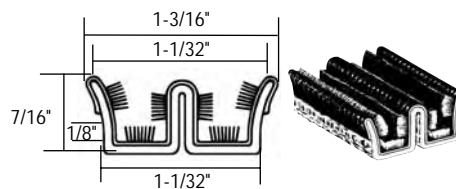

Universal Double Channel

Base Width1-1/32" (26.1 mm)
Top Width1-3/16" (26.3 mm)
Height7/16" (11.1 mm)
Pile Height1/8" (3.2 mm)

CAT. NO.	DESCRIPTION
21414301911C	100 Ft. (30 m) Roll
21414301911	200 Ft. (61 m) Roll

CRL Glass Run Channel Cleaning Tool

- Hook Shaped Tip**



CAT. NO. GCC506

The extra long 24" reach of the CRL Door Glass Channel Cleaning Tool lets you get down into the door glass run channel to clean out broken bits and pieces of tempered glass. The hook shaped tip gets under channel lip and other places you can't normally reach, and removes debris without damage to the channel. Made in the U.S.A.



CRL Glass Run Channel

CRL Unbeaded All-Rubber Channels are OEM quality, and will provide you with the best results when replacing or repairing damaged or missing channels in vehicles. All channels are comprised of an electrostatic flocked rubber to protect the glass and provide quiet operation. Please note the "shoulders" on the outside of some of these channels when determining which channel you require. They are designed to retain the channel in the door glass channel frame and you should choose the one that most closely resembles the channel you are replacing.

AS1340 Flexible*

- Unbeaded
- Electrostatic Flocked Lining
- All-Rubber Channel

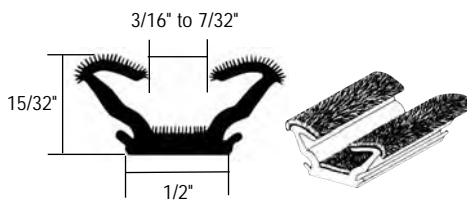

Outside Width.....1/2" (12.7 mm)
 Inside Width.....3/16" – 7/32" (4.9 mm – 5.5 mm)
 Height.....15/32" (11.1 mm)

Applications:
 Ford and Mercury 1963-1967.
 Fairlane and Comet 1966-1971.
 International Truck Cab 1972-1975.

CAT. NO.	LENGTH	PER CASE
AS134096	96" (2.4 m)	25

AS1264 Flexible

- Unbeaded
- Electrostatic Flocked Lining
- All-Rubber Channel

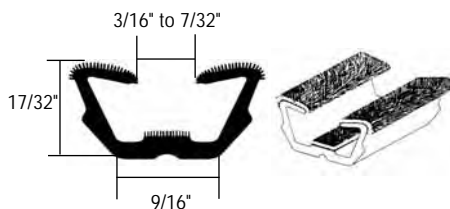

Outside Width.....9/16" (14.3 mm)
 Inside Width.....3/16" – 7/32" (4.9 mm – 5.5 mm)
 Height.....17/32" (13.5 mm)

Applications:
 GM Mid-Size Cars 1960-1967.

CAT. NO.	LENGTH	PER CASE
AS126496	96" (2.4 m)	25

AS1268 Flexible*

- Unbeaded
- Electrostatic Flocked Lining
- All-Rubber Channel

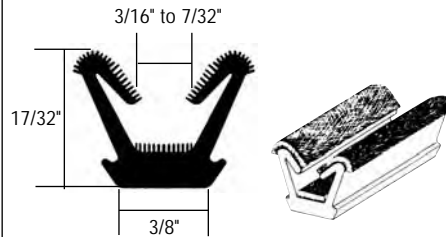

Outside Width.....3/8" (9.5 mm)
 Inside Width.....3/16" – 7/32" (4.9 mm – 5.5 mm)
 Height.....17/32" (13.5 mm)

Applications:
 Valiant and Dart 1963-1966.

CAT. NO.	LENGTH	PER CASE
AS126896	96" (2.4 m)	25

AS1307 Flexible

- Unbeaded
- Electrostatic Flocked Lining
- All-Rubber Channel

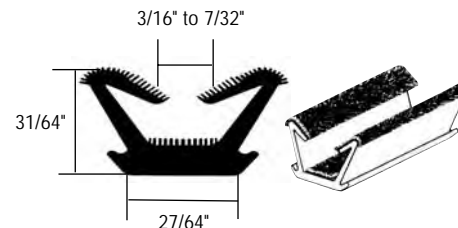

Outside Width.....27/64" (10.7 mm)
 Inside Width.....3/16" – 7/32" (4.9 mm – 5.5 mm)
 Height.....31/64" (12.3 mm)

Applications:
 Plymouth, Dodge, and Chrysler Imperial
 4-Door Models.

CAT. NO.	LENGTH	PER CASE
AS130796	96" (2.4 m)	25

AS1317 Flexible

- Unbeaded
- Electrostatic Flocked Lining
- All-Rubber Channel

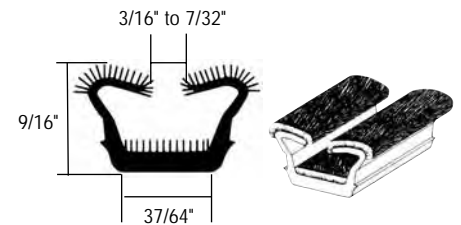

Outside Width.....37/64" (14.6 mm)
 Inside Width.....3/16" – 7/32" (4.9 mm – 5.5 mm)
 Height.....9/16" (14.3 mm)

Applications:
 Chevrolet Trucks 1965-1967.

CAT. NO.	LENGTH	PER CASE
AS131760	60" (1.5 m)	25

AS1198 Flexible

- Unbeaded
- Electrostatic Flocked Lining
- All-Rubber Channel

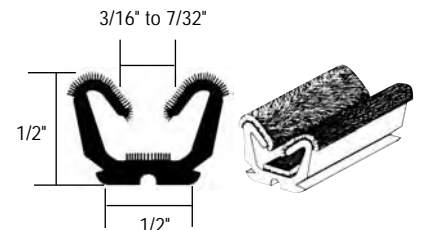

Outside Width.....1/2" (12.7 mm)
 Inside Width.....3/16" – 7/32" (4.9 mm – 5.5 mm)
 Height.....1/2" (12.7 mm)

Applications:
 Valiant and Lancer 1960-1961.

CAT. NO.	LENGTH	PER CASE
AS119896	96" (2.4 m)	25

*Indicates our best selling numbers. All auto channels can be combined for quantity pricing. Packing charge added to orders of less than 12 combined lengths.

CRL Glass Run Channel

AS1369 Flexible

- Unbeaded
- Electrostatic Flocked Lining
- All-Rubber Channel

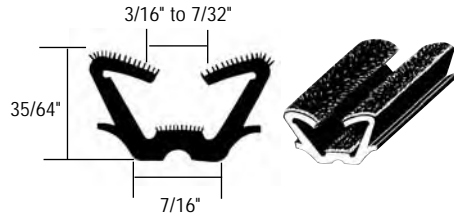

Outside Width.....7/16" (11.1 mm)
 Inside Width.....3/16" – 7/32" (4.9 mm – 5.5 mm)
 Height.....35/64" (13.9 mm)

Applications:
 GM Mid-Size Cars '65-'72.

CAT. NO.	LENGTH	PER CASE
AS136972	72" (1.8 m)	25

AS1528 Flexible

- Unbeaded
- Electrostatic Flocked Lining
- All-Rubber Channel

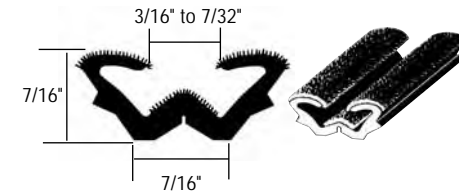

Outside Width.....7/16" (11.1 mm)
 Inside Width.....3/16" – 7/32" (4.9 mm – 5.5 mm)
 Height.....7/16" (11.1 mm)

Applications:
 Universal for Buses and RV Windows.

CAT. NO.	LENGTH	PER CASE
AS152896	96" (2.4 m)	100

AS1395 Flexible

- Unbeaded
- Electrostatic Flocked Lining
- All-Rubber Channel

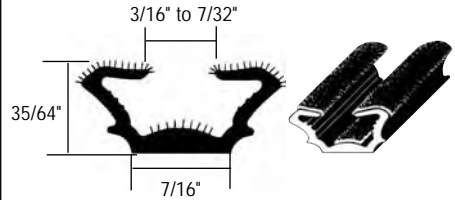

Outside Width.....7/16" (11.1 mm)
 Inside Width.....3/16" – 7/32" (4.9 mm – 5.5 mm)
 Height.....35/64" (13.9 mm)

Applications:
 Ford and Mercury '65-'68.

CAT. NO.	LENGTH	PER CASE
AS139596	96" (2.4 m)	25

AS1720 Flexible

These OEM replacement channels and weatherstrips are for GM 'B' body cars and station wagons. They fit Chevrolet, Pontiac, Oldsmobile, and Buick models from 1977 on.

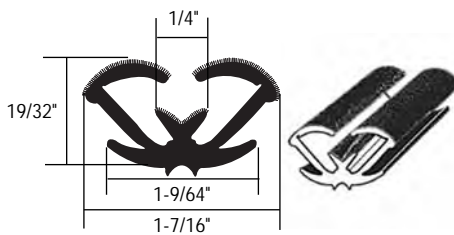

Outside Width.....1-7/16" (36.5 mm)
 Inside Width1/4" (6.4 mm)
 Bottom Flange Width1-9/64" (28.9 mm)
 Height19/32" (15.1 mm)

Applications:
 'B' Body Channel, rear door-header section;
 'B' Body 4-door Channel, front door 'A' pillar header section.

CAT. NO.	LENGTH	PER CASE
AS172096	96" (2.4 m)	25

AS1779 Flexible

These OEM replacement channels and weatherstrips are for GM 'B' body cars and station wagons. They fit Chevrolet, Pontiac, Oldsmobile, and Buick models from 1977 on.

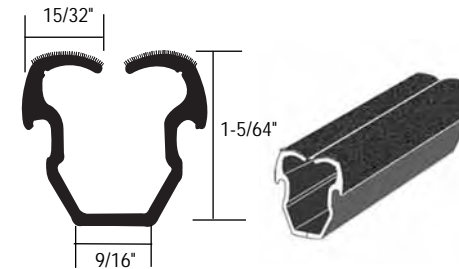

Outside Width9/16" (14.3 mm)
 Top Lip Width15/32" (11.9 mm)
 Height1-5/64" (15.1 mm)

Applications:
 'B' Body Channel, rear door 'B' and 'C' pillar.

CAT. NO.	LENGTH	PER CASE
AS177996	96" (2.4 m)	25

AS1799 Flexible

These OEM replacement channels and weatherstrips are for GM 'B' body cars and station wagons. They fit Chevrolet, Pontiac, Oldsmobile, and Buick models from 1977 on.

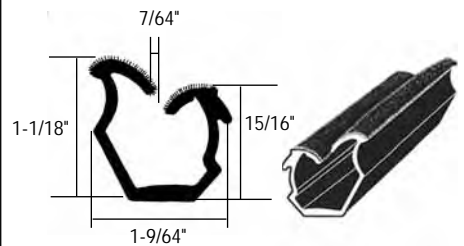

Outside Width.....1-9/64" (28.9 mm)
 Inside Width7/64" (2.8 mm)
 Height (Left Side).....1-1/8" (28.6 mm)
 Height (Right Side).....15/16" (23.8 mm)

Applications:
 'B' Body Channel, front door 'B' pillar.

CAT. NO.	LENGTH	PER CASE
AS179996	96" (2.4 m)	25

All auto channels can be combined for quantity pricing. Packing charge added to orders of less than 12 combined lengths.



LOG ON TO crlaurence.com FOR BUSINESS-TO-BUSINESS SERVICES

A330 | PHONE (800) 421-6144 | FAX (800) 262-3299 TOLL FREE FROM ANYWHERE IN THE U.S.A. OR CANADA

CRL Glass Run Channel

AS1466 Flexible

- Unbeaded
- Electrostatic Flocked Lining
- All-Rubber Channel

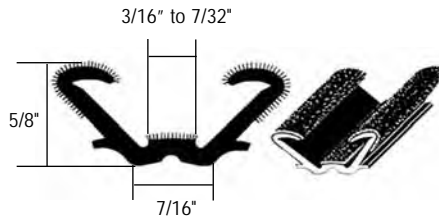

Outside Width.....7/16" (11.1 mm)
Inside Width.....3/16" – 7/32" (4.9 mm – 5.5 mm)
Height.....5/8" (15.9 mm)

Applications:

Chevy II, Chevelle, Tempest and F-85 Oldsmobile '69-'71.

CAT. NO.	LENGTH	PER CASE
AS146696	96" (2.4 m)	25

All auto channels can be combined for quantity pricing. Packing charge added to orders of less than 12 combined lengths.

AS1336 Flexible

- Unbeaded
- Electrostatic Flocked Lining
- All-Rubber Channel

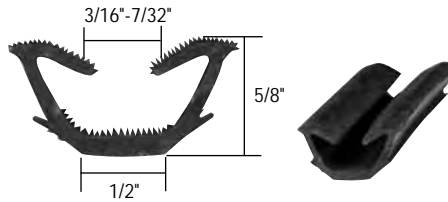

Outside Width.....1/2" (12.7 mm)
Inside Width.....3/16" – 7/32" (4.9 mm – 5.5 mm)
Height.....5/8" (15.9 mm)

Applications:

Universal

CAT. NO.	LENGTH	PER CASE
AS133696	96" (2.4 m)	100

AS1222 Flexible

- Unbeaded
- Electrostatic Flocked Lining
- All-Rubber Channel

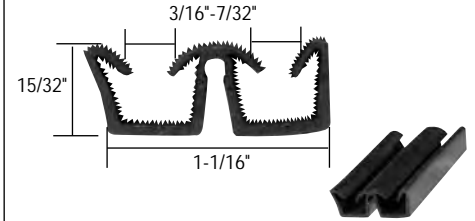

Outside Width.....1-1/16" (27 mm)
Inside Width.....3/16" – 7/32" (4.9 mm – 5.5 mm)
Height.....15/32" (11.9 mm)

Applications:

Universal

CAT. NO.	LENGTH	PER CASE
AS122296	96" (2.4 m)	25

CRL Universal Bottom Channel

- Replace Damaged or Rusted Channels
- Universal Fit

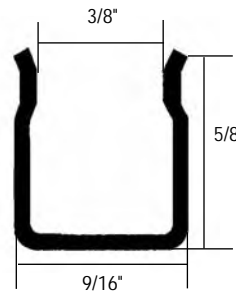

CRL Universal Glass Bottom Channels are OEM quality and will provide you with the best results when replacing or repairing damaged or missing channels in older vehicles. Existing channels can rust out or have been bonded to the glass and are time consuming to clean. By using CRL Universal Channels you will speed your installation and provide a trouble free job. All channels are made of zinc plated steel for long life.

CAT. NO.	LENGTH	PER CASE
CP651139	48" (1.2 m)	50
UC100	96" (2.4 m)	50

All auto channels can be combined for quantity pricing. Packing charge added to orders of less than 12 combined lengths.

CRL Door Glass Lift Channel



Applications:

Door Glass Lift Channel; Plastic
1987 Chrysler Products - Shadow and Sundance 2-Door

CAT. NO.	LENGTH	QTY/PKG
CP886468	14" (35.5 cm)	1

CRL Rigid Side Channel



Applications:

Rigid Side Channel
1941-1961 International Truck, Models A-100 to A180 and C.O.E.

CAT. NO.	LENGTH	PER CASE
200806	37.5" (95.4 cm)	25

All auto channels can be combined for quantity pricing. Packing charge added to orders of less than 12 combined lengths.

Glass Setting Channel

- For 1/8" (3 mm) Glazing



Height.....11/32" (8.7 mm)
Base Width1/4" (6.3 mm)
Inside Width1/8" (3.2 mm)

Qty/Roll 50 Ft (15.2 m)
CAT. NO. AV4511

Glass Setting Channel

- For 1/8" (3 mm) Glazing

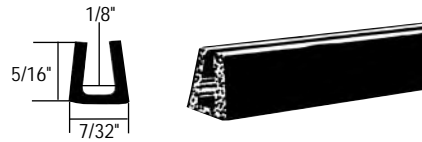

Height.....5/16" (7.9 mm)
Base Width7/32" (5.5 mm)
Inside Width1/8" (3.2 mm)

Qty/Roll 50 Ft (15.2 m)
CAT. NO. AV440

Glass Setting Channel

- For 1/8" (3 mm) Glazing

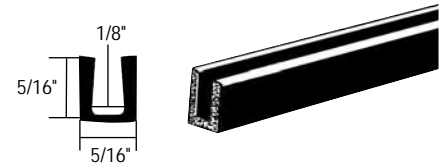

Height.....5/16" (7.9 mm)
Base Width5/16" (7.9 mm)
Inside Width1/8" (3.2 mm)

Qty/Roll 50 Ft (15.2 m)
CAT. NO. AV440A

Glass Setting Channel

- For 3/16" (5 mm) Glazing

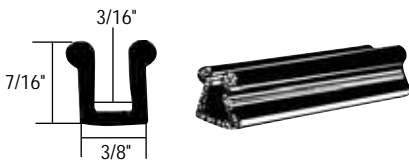

Height7/16" (11 mm)
Base Width3/8" (9.5 mm)
Inside Width3/16" (4.7 mm)

Qty/Roll 50 Ft (15.2 m)
CAT. NO. AV4516

Windshield and Rear Window Glass Setting Channel

- For 3/16" (5 mm) Glazing

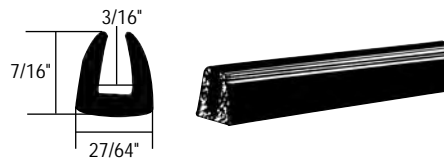

Height7/16" (11 mm)
Base Width27/64" (10.7 mm)
Inside Width3/16" (4.7 mm)

Qty/Roll 50 Ft (15.2 m)
CAT. NO. AV4512

Windshield and Rear Window Glass Setting Channel

- For 1/4" (6 mm) Glazing

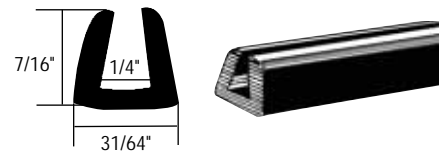

Height7/16" (11 mm)
Base Width31/64" (12.3 mm)
Inside Width1/4" (6.3 mm)

Qty/Roll 50 Ft (15.2 m)
CAT. NO. AV4513

Windshield and Rear Window Glass Setting Channel

- For 1/4" (6 mm) Glazing

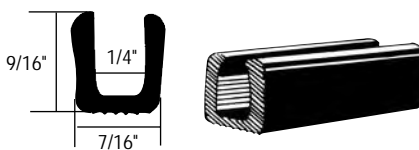

Height.....9/16" (14.3 mm)
Base Width7/16" (11 mm)
Inside Width1/4" (6.3 mm)

Qty/Roll 50 Ft (15.2 m)
CAT. NO. AV4588

Glass Setting Channel

- For 1/4" (6 mm) Glazing

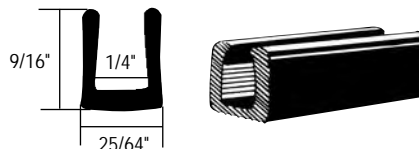

Height.....9/16" (14.3 mm)
Base Width25/64" (12.3 mm)
Inside Width1/4" (6.3 mm)

Qty/Roll 50 Ft (15.2 m)
CAT. NO. AV4515

Glass Setting Channel

- For 1/4" (6 mm) Glazing

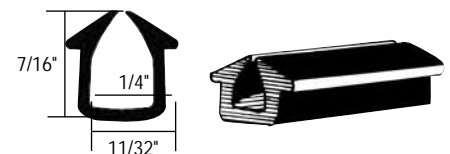

Height.....7/16" (11 mm)
Base Width11/32" (8.7 mm)
Inside Width1/4" (6.3 mm)

Qty/Roll 50 Ft (15.2 m)
CAT. NO. AV539



Glass Setting Channel

- For 1/4" (6 mm) Glazing

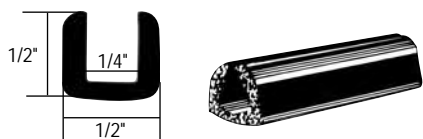

Height1/2" (12.7 mm)
 Base Width1/2" (12.7 mm)
 Inside Width1/4" (6.4 mm)

Qty/Roll 50 Ft (15.2 m)
CAT. NO. AV876

Glass Setting Channel

- For 1/4" (6 mm) Glazing

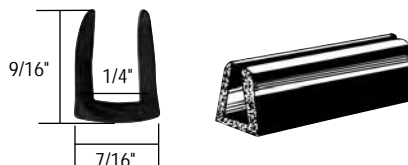

Height9/16" (14.3 mm)
 Base Width7/16" (11.3 mm)
 Inside Width1/4" (6.4 mm)

Qty/Roll 50 Ft (15.2 m)
CAT. NO. AV816

Windshield Glass Weatherstrip

- For 1/4" (6 mm) Glazing

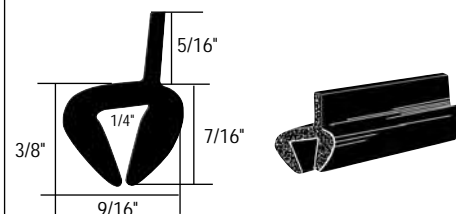

Overall Height3/4" (19.5 mm)
 Base Width9/16" (14.5 mm)
 Inside Width1/4" (6.4 mm)

Qty/Roll 50 Ft (15.2 m)
CAT. NO. AV4581

Rear Window Glass Setting Channel and Weatherstrip

- For 3/16" to 1/4" (5 to 6 mm) Glazing

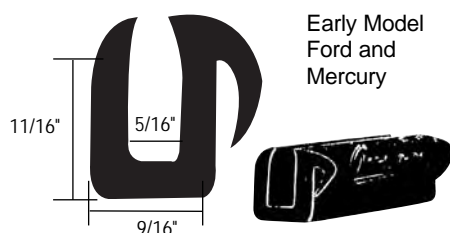

Height11/16" (17.5 mm)
 Base Width9/16" (14.3 mm)
 Inside Width5/16" (7.9 mm)

Qty/Roll 50 Ft (15.2 m)
CAT. NO. AV4670

Rear Window Glass Setting Channel and Weatherstrip

- For 3/16" to 1/4" (5 to 6 mm) Glazing

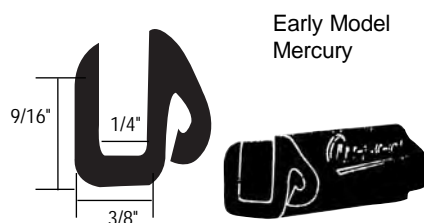

Height9/16" (14.3 mm)
 Base Width3/8" (9.5 mm)
 Inside Width1/4" (6.4 mm)

Qty/Roll 50 Ft (15.2 m)
CAT. NO. AV4671

Rear Window Glass Setting Channel and Weatherstrip

- For 3/16" to 1/4" (5 to 6 mm) Glazing

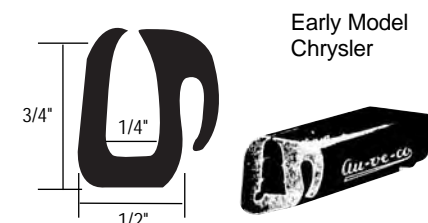

Height3/4" (19.5 mm)
 Base Width1/2" (12.7 mm)
 Inside Width1/4" (6.3 mm)

Qty/Roll 50 Ft (15.2 m)
CAT. NO. AV4688

Tee Rubber with Concave Head



Height3/4" (19.5 mm)
 Head Width9/32" (7.1 mm)

Qty/Roll 50 Ft (15.2 m)
CAT. NO. AV4530

Tee Rubber with Concave Head

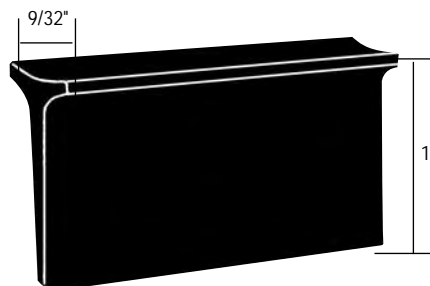

Height1" (25.4 mm)
 Head Width9/32" (7.1 mm)

Qty/Roll 50 Ft (15.2 m)
CAT. NO. AV4531

CRL Windshield Setting Tools



CAT. NO. CRL216
 Tapered Tip on Both Ends



CAT. NO. CRL220
 Chisel Tip on One End; Tapered Tip on Other End

Our Windshield Setting Tools are made of a special high strength yet flexible plastic formula that is non-corrosive and non-conducting. They're great for setting or removing glass from rubber gaskets. For easier handling try our Cat. No. CRL216H Holder with either tool. (see page A312).

CRL Weatherstrips

CRL's Automotive Weatherstrips have a flexible, rubber-covered steel core, which provides moisture-proof corrosion protection. Live rubber cushions the glass and seals the weatherstrip tightly to the molding. Thick wool or propylene pile fabric prevents penetration of dust, drafts, and moisture. The stainless steel bead matches the chrome trim of the car and enhances the appearance of the installation.

NOTE: Although CRL states the original applications for these channels, by using the measurements shown or by matching sample channel to the diagrams, you can use these channels on numerous other vehicles.

YM54R Flexible*

- Stainless Steel Beaded
- Pile Lined
- Rubber-Covered

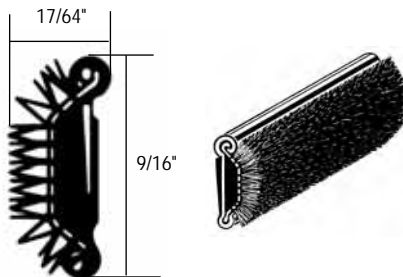

Overall Width17/64" (6.7 mm)
Height9/16" (14.3 mm)

Applications:
GM Cars 1957-1960
American Motors 1948-1962

CAT. NO.	LENGTH	PER CASE
YM54R96	96" (2.4 m)	50

YM3 Flexible*

- Stainless Steel Beaded
- Pile Lined
- Rubber-Covered

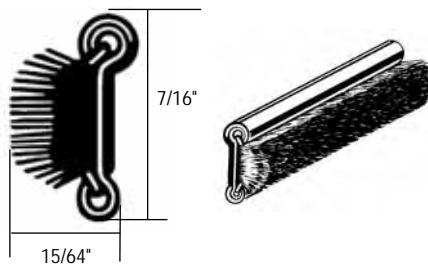

Overall Width15/64" (5.9 mm)
Height7/16" (11.1 mm)

Applications:
GM Cars 1953-1960

CAT. NO.	LENGTH	PER CASE
YM372	72" (1.8 m)	50
YM396	96" (2.4 m)	50

YM52RP Rigid

- Stainless Steel Beaded
- Pile Lined
- Rubber-Covered

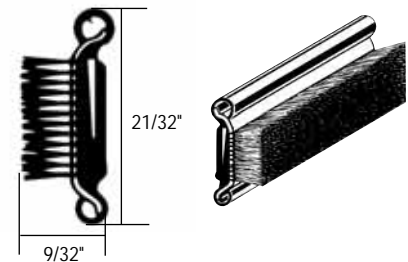

Overall Width9/32" (7.1 mm)
Height21/32" (16.6 mm)

Applications:
Ford Products 1957-1962

CAT. NO.	LENGTH	PER CASE
YM52RP96	96" (2.4 m)	25

YM93 Flexible

- Stainless Steel Beaded
- Pile Lined
- Rubber-Covered

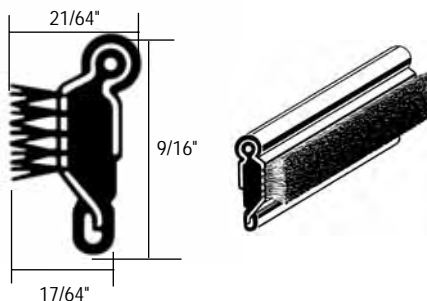

Top Width21/64" (8.3 mm)
Bottom Width17/64" (6.7 mm)
Height9/16" (14.3 mm)

Applications:
Ford Products 1952-1954
Chrysler Products 1957-1964

CAT. NO.	LENGTH	PER CASE
YM9396	96" (2.4 m)	50

YM30 Flexible

- Stainless Steel Bead
- Pile Lined
- Rubber-Covered

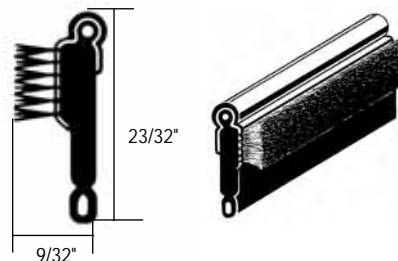

Overall Width9/32" (7.1 mm)
Height23/32" (18.3 mm)

Applications:
Chrysler Products 1953-1963

CAT. NO.	LENGTH	PER CASE
YM3096	96" (2.4 m)	50

YM108X Flexible*

- Stainless Steel Bead
- Rubber Lined
- Rubber-Covered

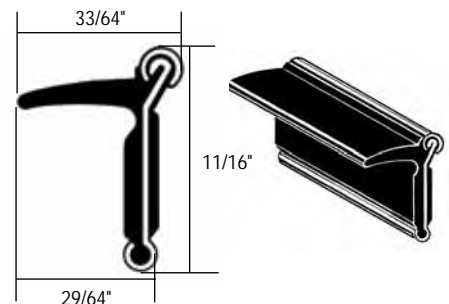

Top Width33/64" (13.1 mm)
Bottom Width29/64" (11.5 mm)
Height11/16" (17.5 mm)

Applications:
GM Cars 1961-1967
Kaiser Jeep 1967-1974

CAT. NO.	LENGTH	PER CASE
YM108X96	96" (2.4 m)	50

* Indicates our best selling numbers. Channels can be combined for quantity pricing. A packing charge will be added to orders of less than 12 combined lengths.



CRL Weatherstrips

YMR13X Rigid

- Stainless Steel Bead
- Electrostatic Flock Lined
- Rubber-Covered

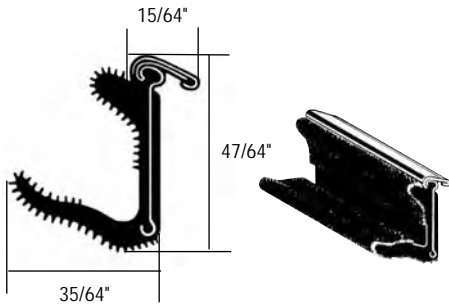

Top Width15/64" (5.9 mm)
 Bottom Width35/64" (13.8 mm)
 Height47/64" (18.6 mm)

Applications:
 GM Cars 1966-1967

CAT. NO.	LENGTH	PER CASE
YMR13X96	96" (2.4 m)	25

YMR219X Rigid

- Stainless Steel Bead
- Electrostatic Flock Lined
- Rubber-Covered

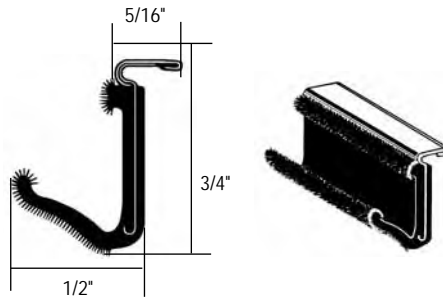

Top Width5/16" (7.9 mm)
 Bottom Width1/2" (12.7 mm)
 Height3/4" (19 mm)

Applications:
 Ford Products 1969-1972

CAT. NO.	LENGTH	PER CASE
YMR219X72	72" (1.8 m)	25

YM197XP Rigid

- Stainless Steel Bead
- Pile Lined
- Rubber-Covered

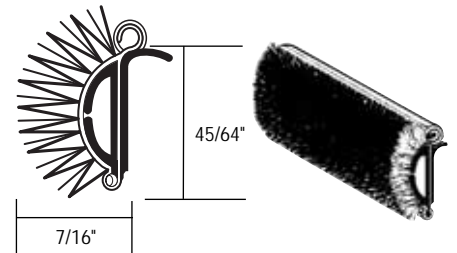

Overall Width7/16" (11.1 mm)
 Height45/64" (17.9 mm)

Applications:
 Universal

CAT. NO.	LENGTH	PER CASE
YM197XP96	96" (2.4 m)	50

CRL Black Edged Weatherstrips

M113 Flexible

- Unbeaded
- Pile Lined
- Rubber-Covered

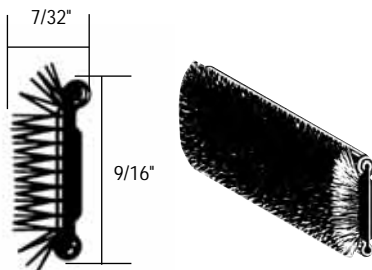

Width7/32" (5.5 mm)
 Height9/16" (14.3 mm)

Applications:
 Chevrolet 1962-1964

CAT. NO.	LENGTH	PER CASE
M11396	96" (2.4 m)	25

M8 Flexible

- Unbeaded
- Pile Lined
- Rubber-Covered

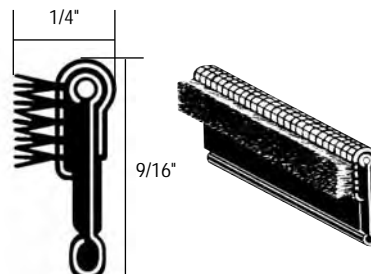

Width1/4" (6.4 mm)
 Height9/16" (14.3 mm)

Applications:
 Jeep 1950-1965
 International Truck 1971-1975
 White Truck 1952-1966

CAT. NO.	LENGTH	PER CASE
M896	96" (2.4 m)	50

M123 Flexible

- Unbeaded
- Pile Lined
- Rubber-Covered

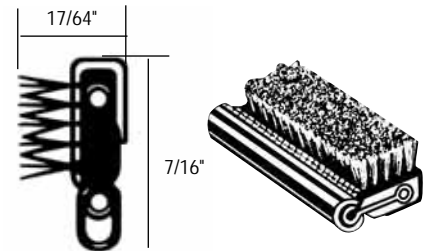

Width17/64" (6.7 mm)
 Height7/16" (2.8 mm)

Applications:
 Chrysler Products 1953-1964

CAT. NO.	LENGTH	PER CASE
M12396	96" (2.4 m)	25

Channels can be combined for quantity pricing. A packing charge will be added to orders of less than 12 combined lengths.
 All Automotive Fasteners can be combined for quantity pricing.

CRL Belt Weatherstrips – Common to GM 'B' body cars from 1977 on.

MR260X Rigid

- Flock Lined
- Rubber-Covered

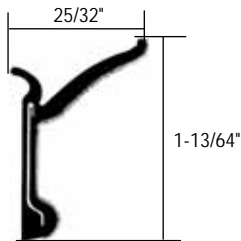

Width25/32" (19.8 mm)
Height.....1-13/64" (30.5 mm)

Applications:

'B' Body Station Wagon: Belt Weatherstrip, quarter window; 'B' Body 4-Door: Belt Weatherstrip, outer rear door.

CAT. NO.	LENGTH	PER CASE
MR260X96	96" (2.4 m)	15

YMR255X Rigid

- Flock Lined
- Rubber-Covered

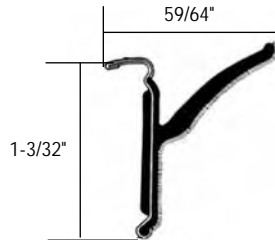

Overall Width59/64" (23.4 mm)
Height1-3/32" (27.8 mm)

Applications:

'B' Body 4-Door: Belt Weatherstrip, inner front door.

CAT. NO.	LENGTH	PER CASE
YMR255X96	96" (2.4 m)	15

YMR256X Rigid

- Flock Lined
- Rubber-Covered

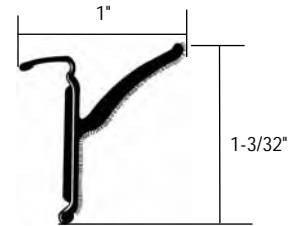

Overall Width1" (25.4 mm)
Height1-3/32" (27.8 mm)

Applications:

'B' Body Station Wagon: Belt Weatherstrip, inner front door.

CAT. NO.	LENGTH	PER CASE
YMR256X96	96" (2.4 m)	15

Channels can be combined for quantity pricing. A packing charge will be added to orders of less than 12 combined lengths.

CRL Weatherstrip Attaching Clips

- Push Through and Slide-On Styles

CRL Weatherstrip Attaching Clips are used to fasten stainless steel and black edged weatherstrips to glass run channel. Choose from push-through or slide-on styles for GM, Ford, Chrysler, and some imports.



Door and Quarter Glass Channel Clip, Metal GM Cars (Not supplied by OEM)

CAT. NO.	QTY/PACK
CP977664	50

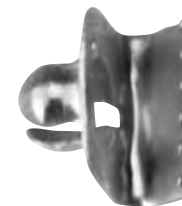

Outer Weatherstrip Clip, Metal GM, Ford, Chrysler, and some imports

CAT. NO.	QTY/PACK
CP855973	50



Outer Weatherstrip Clip, Metal Door and Quarter Window Chrysler '67-'72

CAT. NO.	QTY/PACK
CP713483	100



Glass Run Channel Clip, Metal GM Compact Cars '63 - '64.

CAT. NO.	QTY/PACK
SC3345	100



Glass Run Channel Clip, Metal Various Ford Products

CAT. NO.	QTY/PACK
SC3348	100



CRL Weatherstrip Clips



Door Weatherstrip Fastener; Plastic
Hole: 4.5 mm; Head: 5 x 13 mm
Panel Range: 6 mm
All GM '63+, Ford '65+

Qty/Pkg 50
CAT. NO. CP998033



Door Weatherstrip Clip; Black Plastic
Hole: 5 mm; Stem Length: 15.5 mm
Head Dia.: 10 mm
Neon '95+, GM

Qty/Pkg 50
CAT. NO. CP977686



Weatherstrip Clip; Plastic
Hole: 6 mm; Head Dia.: 10 mm
Grip Range: 2.0 - 7.0 mm
GM Various Model '86+

Qty/Pkg 100
CAT. NO. CP886409



Weatherstrip Clip; Black Plastic
Hole: 3/16" mm; Head: 3/16" x 9/16"
Panel Range: .050
Lincoln '89+, Expedition '97+

Qty/Pkg 50
CAT. NO. CP927013



Weatherstrip Clip,
Front and Rear Doors; White Plastic
Hole: 5 mm; Head: 6.5 x 16.5 mm
Panel Range: 1.5 mm
Chrysler LH Models '93+

Qty/Pkg 100
CAT. NO. CP937196



Weatherstrip Clip; Nylon
Hole: 5/16"; Head Size: 3/16" x 9/16"
Panel Range: .050
Jeep and GM Trucks

Qty/Pkg 50
CAT. NO. CP937173



Weatherstrip Clip; Plastic
Datsun, Honda

Qty/Pkg 50
CAT. NO. CP825506



Weatherstrip Clip; Plastic
Toyota Truck

Qty/Pkg 50
CAT. NO. CP866063



Weatherstrip and Trim Panel Clip; Plastic
Toyota and Datsun

Qty/Pkg 100
CAT. NO. CP764333



Rear End Belt Molding Clip; Plastic
Cars with Vinyl Tops;
'81-'88 Olds, Cutlass 'G' Body

Qty/Pkg 15
CAT. NO. CP947227



Outer Weatherstrip Clip; Metal
GM, Ford and Chrysler,
Some Imports

Qty/Pkg 50
CAT. NO. CP855973



Outer Weatherstrip Clip; Metal
Door and Quarter Window
Chrysler '67-'72

Qty/Pkg 100
CAT. NO. CP713483



Door and Quarter Glass Channel Clip; Metal
GM Cars

Qty/Pkg 50
CAT. NO. CP977664



Glass Run Channel Clip; Metal
GM Compact Cars '63 -'64

Qty/Pkg 100
CAT. NO. SC3345



Glass Run Channel Clip; Metal
Various Ford Models

Qty/Pkg 100
CAT. NO. SC3348

CRL Universal Channel Moldings

- **Black Color EPDM Rubber Moldings Available with or without Pre-Applied Butyl**
- **Smooth Surface and Feature Line Moldings Can Be Used in Over 600 Makes and Models from 1979 and Up**
- **Cut to Length Rolls Mean No Waste**

CRL Gold Glass Universal Moldings are intended to be a replacement for moldings damaged during glass removal. They are applied to the glass prior to installation, and can be used as a substitute for moldings now being used on General Motors, Daimler-Chrysler, Ford, BMW, Honda, Mazda, Nissan, Toyota, Volkswagen, and other vehicles. With their universal styling, they eliminate the need to carry a large inventory of specialized moldings, and can be used in over 600 domestic and import applications.

Universal Channel Moldings quickly install over the edge of the glass. Additional retention is achieved when using the Universal Channel Molding with the Butyl pre-applied in the channel.

CRL Universal Moldings with Pre-Applied Butyl

- **Four Sizes without Feature Line**

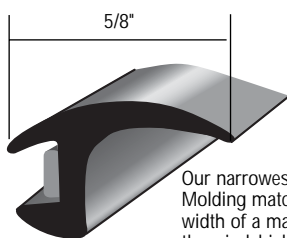

5/8" (15.9 mm) Wide
Qty/Pkg 75 Feet (30.5 m)
CAT. NO. 409T105B

Our narrowest Channel Molding matches the width of a majority of the windshield and back glass moldings.

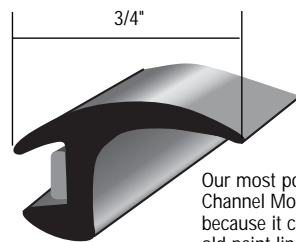

3/4" (19 mm) Wide
Qty/Pkg 75 Feet (22.9 m)
CAT. NO. 409T107B

Our most popular Channel Molding because it covers old paint lines.

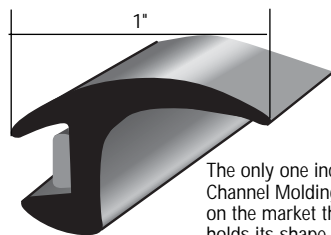

1" (25.4 mm) Wide
Qty/Pkg 75 Feet (22.9 m)
CAT. NO. 409T108B

The only one inch Channel Molding on the market that holds its shape.

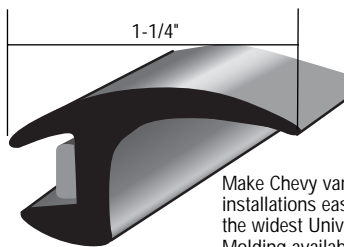

1-1/4" (31.7 mm) Wide
Qty/Pkg 65 Feet (19.8 m)
CAT. NO. 409T109B

Make Chevy van installations easier with the widest Universal Molding available.

- **Two Sizes with Feature Line for Improved Appearance**

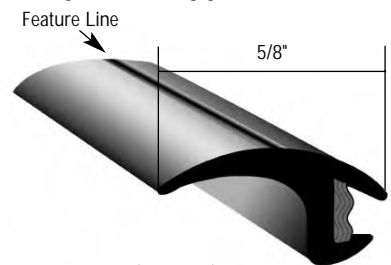

5/8" (15.9 mm) Wide
Qty/Pkg 75 Feet (22.9 m)
CAT. NO. 409T105BFL

Feature Line

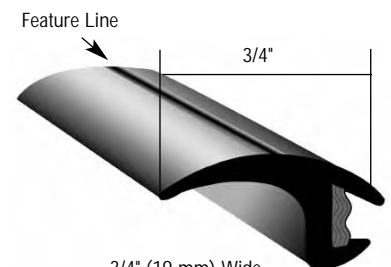

3/4" (19 mm) Wide
Qty/Pkg 75 Feet (22.9 m)
CAT. NO. 409T107BFL

Feature Line

CRL Universal Channel Moldings without Butyl

- **Three Sizes without Feature Line**

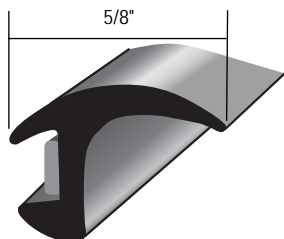

5/8" (15.9 mm) Wide
Qty/Pkg 75 Feet (22.9 m)
CAT. NO. 409T105

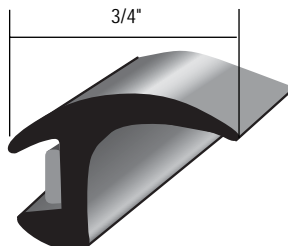

3/4" (19 mm) Wide
Qty/Pkg 75 Feet (22.9 m)
CAT. NO. 409T107

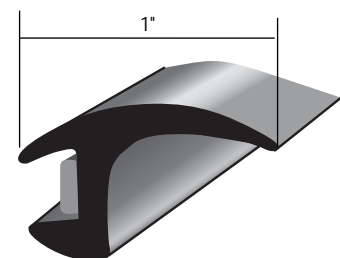

1" (25.4 mm) Wide
Qty/Pkg 75 Feet (22.9 m)
CAT. NO. 409T108



CRL Universal Channel Moldings

CRL Insert Molding with Adhesive

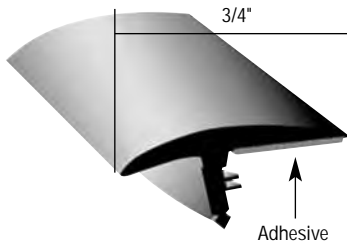

Available in EPDM (matte finish), and features a self-adhesive strip on the glass side for perfect trouble-free installations.

3/4" (19 mm) Wide
Qty/Pkg 75 Feet (22.9 m)
CAT. NO. 409T110

CRL Universal Chrome Molding

The addition of a chrome finish strip makes this Universal Molding especially attractive. Black color vinyl has pre-applied butyl.

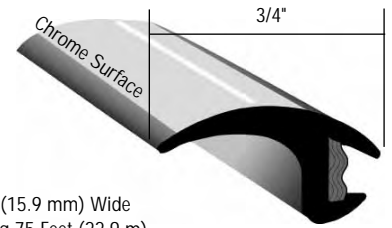

5/8" (15.9 mm) Wide
Qty/Pkg 75 Feet (22.9 m)
CAT. NO. 409T120BC

CRL Cavity Moldings

• Black Color Vinyl in Two Sizes with Pre-Applied Butyl

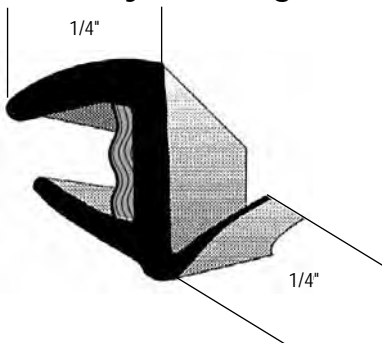

1/4" (6.3 mm) Size
Qty/Pkg 120 Feet (36.6 m)
CAT. NO. 409T100B

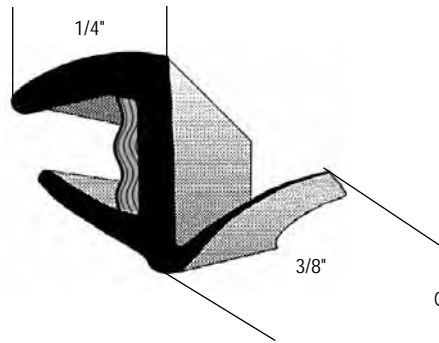

3/8" (9.5 mm) Size
Qty/Pkg 90 Feet (27.4 m)
CAT. NO. 409T101B

new

CRL Universal Molding Application Chart



CAT. NO. 409TAC

CRL Gold Glass Universal Moldings come in a complete array of types and sizes. Order our Cat. No. 409TAC Universal Molding Application Chart to look up the correct molding for a specific vehicle. Or you might prefer our Cat. No. 409TSC Universal Molding Specimen Chain with short pieces of each molding. It makes it easy for you to match the molding you are replacing with the proper CRL Gold Glass Universal Molding for your customer's vehicle.

CRL Universal Molding Specimen Chain



CAT. NO. 409TSC

CRL Multi-Cutter

The CRL Multi-Cutter is great for cutting PVC strips, rubber gaskets, molding, and weatherstrip. Simply align the material to be cut with the desired angle line on the tool's platform and you have a perfect 90°, 75°, 60° or 45° miter cut every time. The cutter is made of high quality steel with vinyl handgrips which allow for comfort when cutting. Includes five extra blades.



CAT. NO. MC80

CRL Molding Adhesive

• Permanent, Transparent Bond

CRL Loctite Bonder Adhesive sets in seconds to form a permanent transparent bond. Effective on metal, rubber, aluminum, ceramics, vinyl, alloys, plastics, and other non-porous surfaces. One ounce comes ready to use.



CAT. NO. 49550

CRL Channel Moldings

CRL Value-Priced Channel Moldings with Butyl

- Black Color EPDM Rubber Moldings, All with Pre-Applied Butyl

new

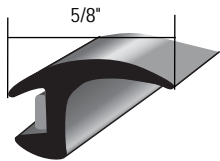

5/8" (15.9 mm) Wide
Qty/Pkg 75 Feet (22.9 m)
CAT. NO. ET105B

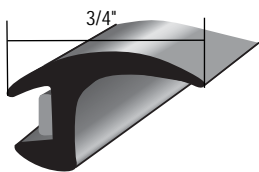

3/4" (19 mm) Wide
Qty/Pkg 75 Feet (22.9 m)
CAT. NO. ET107B

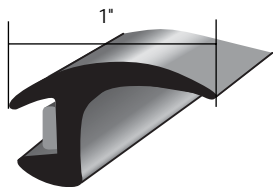

1" (25.4 mm) Wide
Qty/Pkg 75 Feet (22.9 m)
CAT. NO. ET108B

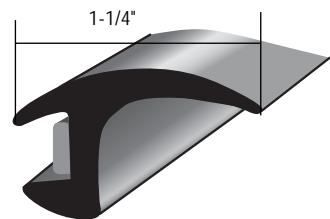

1-1/4" (31.7 mm) Wide
Qty/Pkg 65 Feet (19.8 m)
CAT. NO. ET109B

CRL Value-Priced Feature Line Channel Moldings with Butyl

new

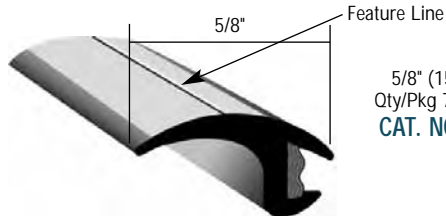

5/8" (15.9 mm) Wide
Qty/Pkg 75 Feet (22.9 m)
CAT. NO. ET105BFL

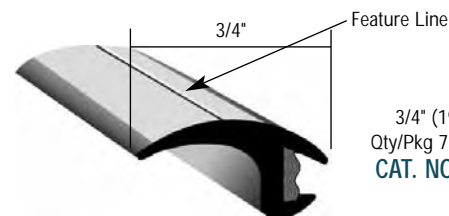

3/4" (19 mm) Wide
Qty/Pkg 75 Feet (22.9 m)
CAT. NO. ET107BFL

CRL Foam Underside Molding

new

- Closed Cell Foam Molding Specifically Designed for Exposed Edge Glass with Tight Radius Corners

CRL Foam Underside Molding is specifically designed to replace moldings that have been damaged when replacing quarter and back glasses that have tight radius corners. It has a pre-applied adhesive that holds it firmly in place. Dual extruded roll contains 100 total feet of Molding.

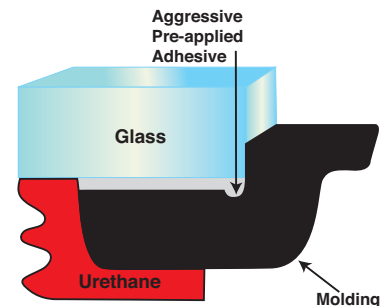

Qty/Pkg 100 Feet (30.5 m)
CAT. NO. 409T202

CRL Underside Molding

new

- Designed for Exposed Edge Glass
- Bonds Well with All Urethanes

CRL Underside Molding is used to replace moldings that get damaged when you remove and replace exposed edge glass used on many newer vehicles. It has a pre-applied adhesive strip that bonds directly to the underside of the glass. Dual extruded roll contains 90 total feet of Molding.

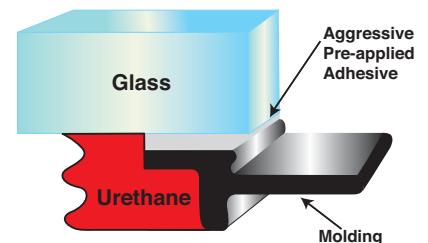

Qty/Pkg 90 Feet (27.4 m)
CAT. NO. 409T201

CRL Underside Molding Installation Tool

- Quickly Installs Our 409T201 Underside Molding

new

The CRL Underside Molding Installation Tool takes the work out of installing our 409T201 Underside Molding. The tool holds the Molding in perfect position and quickly feeds it on to the glass at a consistent distance from the outside edge. Made from heavy-duty plastic material that will give you years of service.



CAT. NO. 409T00L



CRL Buick Riviera and 'X' Body Hatchback Windshield Molding

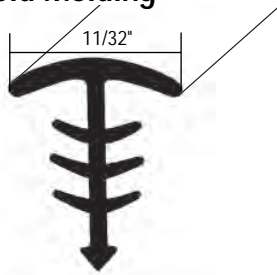

Black Plastic
Qty/Pkg 100 feet (30.5 m) Roll
CAT. NO. CP795140

CRL Chevrolet Chevette and Pontiac T-1000 Windshield Molding

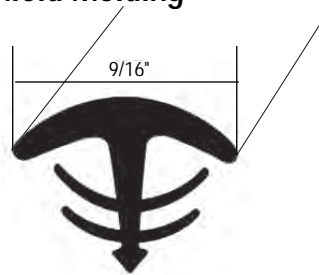

Black Plastic
Qty/Pkg 100 feet (30.5 m) Roll
CAT. NO. CP815395

CRL Buick Riviera and 'X' Body Hatchback Windshield Molding

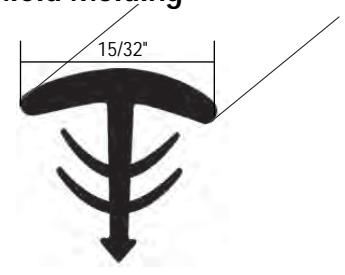

Black Plastic
Qty/Pkg 100 feet (30.5 m) Roll
CAT. NO. CP815396

CRL 1986 - 1996 Ford Aerostar Windshield Molding

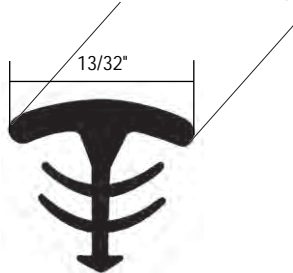

Black Plastic
Qty/Pkg 100 feet (30.5 m) Roll
CAT. NO. CP876261

CRL 1984+ Chrysler Mini Vans Windshield Molding

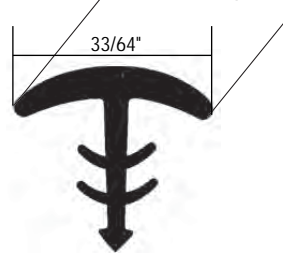

Black Plastic
Qty/Pkg 100 feet (30.5 m) Roll
CAT. NO. CP876262

CRL 1986+ Chrysler Mini Vans Back Glass Molding

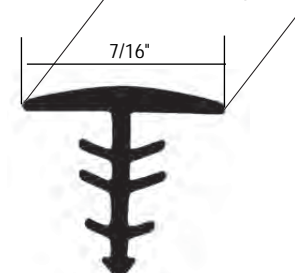

Black Plastic
Qty/Pkg 100 feet (30.5 m) Roll
CAT. NO. CP876316

CRL Universal Windshield Molding

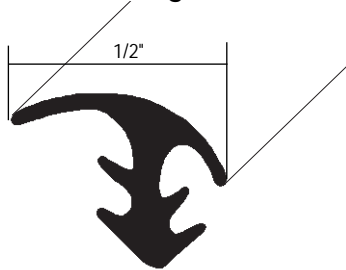

Black Plastic
Qty/Pkg 100 feet (30.5 m) Roll
CAT. NO. WFSR100

CRL Hot Air Gun

- Three Temperature Settings
- Double Insulated for Safety
- Warms Moldings for Better Fit

This CRL Hot Air Gun has three heat settings to supply hot air: 120°, 800° and 1,050° F (49°, 427° and 566° C). The CRL Hot Air Gun is excellent for use to warm moldings to ensure a good fit. Also helpful for putty removal, paint removal, plastic pipe welding, and other jobs. It is double insulated for safety.



CAT. NO. HL1502S

Windshield Molding Tools and Supplies

CRL has a complete selection of products for removing, inserting, and securing Windshield Moldings.



U-blade Knife
See Page A173



Air-Flow Molding Tape
See Page A342



Trim Securing Tape
See Page A343



Suck-N-Clamp
See Page A262

CRL Air-Flow Molding Retention Tape*

new

- Vapor Permeable Tape Breathes Over Entire Surface to Speed Cure Rates
- Orange or Clear Color With or Without Printed 24 Hour Warning
- Perforated Every 6" for Easy Tearing

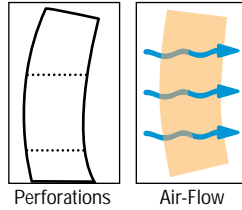

Our Air-Flow Molding Tape uses new technology never before seen in molding tapes. This tape allows moisture vapor to permeate through, curing the urethane at a faster rate than any other Molding Retention Tape. Perforations every 6" (152 mm) throughout the roll makes it easy to tear off perfect size strips to hold down corners. 108 feet (32.9 m) per roll.

ORANGE CAT. NO.	CLEAR CAT. NO.	24 HOUR IMPRINT	WIDTH	ROLLS/ CASE
AFT112	AFT112C	NO	1-1/2" (38 mm)	32
AFT112W	AFT112CW	YES	1-1/2" (38 mm)	32
AFT2	AFT2C	NO	2" (51 mm)	24
AFT2W	AFT2CW	YES	2" (51 mm)	24

Sizes and colors can be combined for quantity pricing.

CRL Vinyl Molding Retention Tape*

new

- Temporarily Holds Moldings
- Perforated Every 6" for Easy Tearing
- Orange or Clear Color With or Without Printed 24 Hour Warning

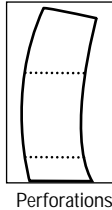

Clear with Imprint

Clear without Imprint

Designed to temporarily hold moldings while auto urethane adhesives cure. Vinyl tape repels water better than masking tapes. Perforations every 6" (152 mm) throughout the roll makes it easy to tear off perfect size strips to hold down corners. 108 feet (32.9 m) per roll.

ORANGE CAT. NO.	CLEAR CAT. NO.	24 HOUR IMPRINT	WIDTH	ROLLS/ CASE
MT112	MT112C	NO	1-1/2" (38 mm)	32
MT112W	MT112CW	YES	1-1/2" (38 mm)	32
MT2	MT2C	NO	2" (51 mm)	24
MT2W	MT2CW	YES	2" (51 mm)	24

Sizes and colors can be combined for quantity pricing.



Orange with Imprint

Orange without Imprint

*Warning: Do not use with or on lacquers, wallpapers, unpainted wallboard, or poorly bonded re-painted finishes. Purchaser shall be solely responsible for determining the adequacy of these products for any and all uses to which the purchaser shall apply these products, and the application of these products by the purchaser shall not be subject to any implied warranty of fitness for that purpose. Statements or descriptions of these products are for information only, and not made or given as a warranty of these products in any way.

CRL Automotive Masking Tape

- Adheres Evenly
- Strips Clean



Professional auto body shops use CRL Automotive Masking Tape for refinish painting. Its excellent conformability and stain-resistant curing adhesive let you do it right the first time. Eliminates paint build-up along the tape line, and strips clean.

CAT. NO.	WIDTH	ROLL LENGTH	ROLLS/CASE
13934	3/4" (19 mm)	180' (54.8 m)	48
1392	2" (51 mm)	180' (54.8 m)	24

Sizes can be combined for quantity pricing.

CRL 3M™ Automotive Masking Tape

- Expressly for the Professional Auto Paint Refinisher
- Solvent Resistant



Made expressly for the professional auto paint refinisher, 3M™ Automotive Masking Tape features good holding power, conformability, instant adhesion, solvent resistance, and smooth texture. It unwinds easily from the roll, and stretches around moldings, handles, etc., without pulling away.

CAT. NO.	WIDTH	ROLL LENGTH	ROLLS/CASE
3M26334	3/4" (19 mm)	180' (54.8 m)	48
3M26336	1" (25.4 mm)	180' (54.8 m)	36
3M26340	2" (51 mm)	180' (54.8 m)	24

Sizes can be combined for quantity pricing.



LOG ON TO crlaurence.com FOR BUSINESS-TO-BUSINESS SERVICES

A342 | PHONE (800) 421-6144 | FAX (800) 262-3299 TOLL FREE FROM ANYWHERE IN THE U.S.A. OR CANADA

CRL Blue Windshield and Trim Securing Tape*

- Holds Molding While Urethane Cures
- Leaves No Adhesive Residue for Up to Seven Days

CRL Blue Windshield and Trim Securing Tape is a blue crepe paper tape with built-in UV stability and adhesive transfer resistance for up to seven days. Ideal for holding in moldings on urethane-set windshields, also as a masking tape for tooled silicone joints in frameless shower door installations, or any exterior sealing applications, such as storefronts where the metal needs to be protected.



CAT. NO.	WIDTH	ROLL LENGTH	ROLLS/CASE
BL9934	3/4" (19 mm)	180 Ft. (54.8 m)	48
BL991	1" (25.4 mm)	180 Ft. (54.8 m)	36
BL99112	1-1/2" (38 mm)	180 Ft. (54.8 m)	24
BL992	2" (51 mm)	180 Ft. (54.8 m)	24

All tapes on this page can be combined for quantity pricing.

CRL 3M™ Blue Windshield and Trim Securing Tape*

- Used to Hold Molding While Urethane Cures
- Leaves No Adhesive Residue for Up to 14 Days

CRL 3M™ Blue Windshield and Trim Securing Tape is most commonly used for holding the trim around newly installed windshields while the urethane sets. It has UV stability and resists adhesive transfer for up to 14 days after application.

CAT. NO.	WIDTH	ROLL LENGTH	ROLLS/CASE
3M6817	3/4" (19 mm)	180 Ft. (54.8 m)	48
3M6818	1" (25.4 mm)	180 Ft. (54.8 m)	36
3M6819	1-1/2" (38 mm)	180 Ft. (54.8 m)	24
3M6820	2" (51 mm)	180 Ft. (54.8 m)	24

All tapes on this page can be combined for quantity pricing.



CRL Deluxe Windshield and Trim Securing Tape*

- Works in Temperatures from 30 to 200°F
- Contains Special UV Inhibitors
- Never Leaves a Residue

CRL Deluxe Windshield and Trim Securing Tape is a high strength, 9 mil thick white polyethylene tape with special UV inhibitors and adhesive. It will work in temperatures from 30 to 200°F (-1 to 93°C) and will never leave a residue, even when left on for days. You can feel confident that no cleanup will ever be required securing the windshield and trim with this tape.

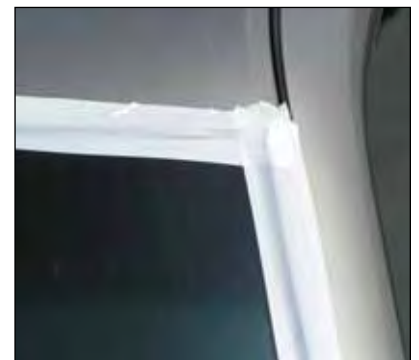

CAT. NO.	WIDTH	ROLL LENGTH	ROLLS/CASE
921W	1" (25.4 mm)	108 Ft. (32.9 m)	48
922W	2" (51 mm)	108 Ft. (32.9 m)	24

All tapes on this page can be combined for quantity pricing.

*WARNING

These products are not recommended for use on poorly repainted or lacquered surfaces. Purchaser shall be solely responsible for determining the adequacy of these products for any and all uses to which the purchaser shall apply these products, and the application of these products by the purchaser shall not be subject to any implied warranty of fitness for that purpose. Statements or descriptions of these products are for information only, and not made or given as a warranty of these products in any way.

CRL Multi-Purpose Masking Tape

- Economical with Hundreds of Uses
- Six Convenient Widths
- High Quality Adhesive

Use CRL Multi-Purpose Masking Tape for masking, packaging, bundling, sealing, "X"-ing window glass, or for many other jobs. Designed to stick to all surfaces, smooth or rough, it easily conforms to irregular shapes. This high quality, low-priced tape is packed in plastic sleeves to keep it fresh for a long shelf life.



CAT. NO.	WIDTH	ROLL LENGTH	ROLLS/CASE
40312	1/2" (12 mm)	180' (54.8 m)	72
40334	3/4" (19 mm)	180' (54.8 m)	48
4031	1" (25.4 mm)	180' (54.8 m)	36
403112	1-1/2" (38 mm)	180' (54.8 m)	24
4032	2" (51 mm)	180' (54.8 m)	24
4033	3" (76 mm)	180' (54.8 m)	16

Sizes can be combined for quantity pricing.

CRL Duct Tape

- Flexible and Versatile
- Highly Aggressive Adhesive



CRL Duct Tape is a bonding of highly aggressive natural adhesive to a strong cloth tape with a coating of polyethylene. It is resistant to moisture and heat extremes, and conforms well to corners and sharp edges.

Typical uses include: Sealing duct work in exhaust and dryer vents, air conditioning and heating systems; as a pipe insulation wrap; temporary repair for fractured fiberglass or plastic panels; to bundle electrical cords; as a general adhesive tape when securing large sheets of protective cloth or plastic.

CAT. NO.	COLOR	WIDTH	ROLL LENGTH	ROLLS/CASE
C5192	Gray	2" (51 mm)	180' (54.8 m)	24
C5193	Gray	3" (76 mm)	180' (54.8 m)	16
C5292	Black	2" (51 mm)	180' (54.8 m)	24

Sizes can be combined for quantity pricing.



- Gray or Black Color

CRL Friction Tape

- An Auto Glass Shop Favorite for Setting Glass
- Tacky Adhesive on Both Sides

CRL Friction Tape is a heavy fabric tape with a tacky adhesive on both sides. A long time favorite in auto glass shops for setting vent and door glass in channels, you will find it has many industrial and manufacturing uses. Each roll is individually wrapped to preserve shelf life.

CAT. NO.	WIDTH	ROLL LENGTH	ROLLS/CASE
FT34	3/4" (19 mm)	60' (18.3 m)	50
FT112	1-1/2" (38 mm)	60' (18.3 m)	50

Sizes can be combined for quantity pricing.



CRL Cork and Rubber Tuff-Pak Glass Setting Tape

- Compresses for Tight Seal
- Cushions Glass



The cork content in CRL Tuff-Pak Glass Setting Tape makes it compressible, for a strong setting that is both a cushion and a tight seal. Tuff-Pak has the right proportion of cork and rubber to provide an all-purpose tape with these specific advantages; flexibility, better grip on glass, high cork content, superior cloth backing, and versatility. Tuff-Pak Tape is the accepted standard of the auto glass industry.

CAT. NO.	WIDTH	ROLL LENGTH
690	1/32" (0.79 mm)	100 Ft. (30.5 m)
720	1/16" (1.58 mm)	100 Ft. (30.5 m)
760	5/64" (1.98 mm)	50 Ft. (15 m)
770	3/64" (1.19 mm)	100 Ft. (30.5 m)
820	3/32" (2.38 mm)	50 Ft. (15 m)

CRL Sealstrip Glass Setting Tape

- Firmly Retains Glass
- Prevents Breakage



CRL Sealstrip holds glass firmly and for keeps. Seals against dirt, moisture and weather. Insulates against sound and vibration, and won't stretch out of shape.

CAT. NO.	WIDTH	ROLL LENGTH
A4264	1/32" (0.79 mm)	100 Ft. (30.5 m)
A4262	1/16" (1.58 mm)	100 Ft. (30.5 m)
A46142	5/64" (1.98 mm)	100 Ft. (30.5 m)
A4263	3/64" (1.19 mm)	100 Ft. (30.5 m)
A4261	3/32" (2.38 mm)	100 Ft. (30.5 m)

CRL Mohair Channel Liner

- Rubberized Backing
- Refurbish Old Glass Run Channels



CRL Mohair Channel Liner is a black mohair lining material with rubberized backing. Apply adhesive to back of liner and bond to badly worn division bars and channels on cars and trucks. Re-lines guide bars on lock side of hardtops and convertibles. It can also be cut into shapes and glued to bases to protect glass desktops and shelves.

CAT. NO.	WIDTH	ROLL LENGTH
6112	1-5/8" (41.3 mm)	50 Ft. (15.2 m)
6114	2-5/8" (66.7 mm)	40 Ft. (12.2 m)

CRL Moleskin Channel Liner

- Adhesive Backed
- Full Width or in 1/4" Strips



CRL Moleskin Channel Liner is a black-colored, fine felt bonded to an adhesive-coated backing film. It has many diverse uses, such as acting as a liner for glass run channel, a cushion between "show-case" glass and frames, or as a protective liner on the bottom of objects to be displayed on glass shelves.

CAT. NO.	DESCRIPTION	ROLL LENGTH
C5901	Solid 1" (25.4 mm) Wide	100 Ft. (30.5 m)
C590290	Solid 2" (50.8 mm) Wide	100 Ft. (30.5 m)
C590190	1/4" (6.4 mm) Strips 1" (25.4 mm) Wide	100 Ft. (30.5 m)

CRL Dor-Tite Sponge Rubber Weatherstripping

- Weatherproofs and Cushions Against Vibrations, Rattles, and Drafts
- Self-Adhesive – Easy to Apply
- Endless Applications



CRL Dor-Tite is a black, open cell, Sponge Rubber Weatherstripping with adhesive on one side that can be used in a variety of applications: cushioning, insulating, dustproofing, weatherproofing, sealing, rattleproofing and more.

Dor-Tite is used by the manufacturers of campers, trailers, freezer boxes, metal buildings, electrical control panel boxes, office furniture, and mobile homes. It makes an effective weather seal around air conditioning and heater units. It can also be used as a jamb seal for sliding doors and windows. Available in different widths and thicknesses to fit most any size joint. Dor-Tite is easy to use – just remove the adhesive cover and apply. No clean up is required. The strip's exposed surface has a very fine satin finish and is non-stretchable.

CAT. NO.	WIDTH	THICKNESS	FEET/ROLL	ROLLS/CASE
D3450	1/2" (12 mm)	3/16" (5 mm)	50 (15.2 m)	20
D3850	1" (25 mm)	3/16" (5 mm)	50 (15.2 m)	20
D4450	1/2" (12 mm)	1/4" (6 mm)	25 (7.6 m)	20
D4650	3/4" (19 mm)	1/4" (6 mm)	50 (15.2 m)	15
D4850	1" (25 mm)	1/4" (6 mm)	25 (7.6 m)	15
D9425	1/2" (12 mm)	9/16" (14 mm)	50 (15.2 m)	10
D9625	3/4" (19 mm)	9/16" (14 mm)	50 (15.2 m)	10
D9825	1" (25 mm)	9/16" (14 mm)	25 (7.6 m)	10

Sizes can be combined for quantity pricing.

CRL Putty Tape

- Extruded Caulking Tape Used to Seal Between Vehicle Body and Aluminum Window Frames
- Great for Van and RV Windows



Use CRL Putty Tape to seal between the vehicle body and frames of aluminum windows. Originally designed for manufacturers of mobile homes, campers and RVs, the material stays soft and pliable, so it installs easily and conforms well to corners. It comes rolled on specially treated release paper for easy handling, and is easy to clean up.

CAT. NO.	COLOR	WIDTH	THICKNESS	FEET/ROLL	ROLLS/CASE
PT34X18	Gray	3/4" (19 mm)	1/8" (3 mm)	30 (9.1 m)	20
PT1X18	Gray	1" (25 mm)	1/8" (3 mm)	30 (9.1 m)	16

Sizes can be combined for quantity pricing. Minimum order is one case.

CRL Wonder Tape

- Our Most Versatile Sealant, Adhesive, and Caulking Tape
- Virtually Unlimited Shelf Life

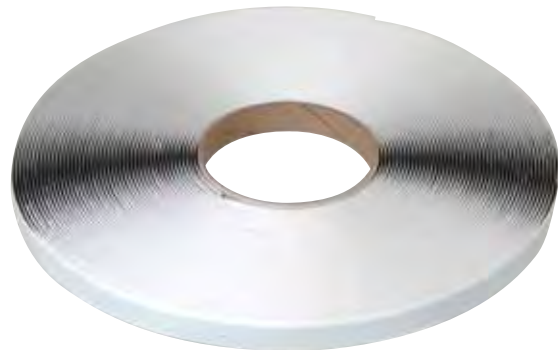

CRL Wonder Tape is an extruded tape with outstanding adhesion to almost any surface. It bonds instantly and is useful in automotive, building, and industrial applications. It performs equally well in bonding, sealing, and caulking applications, and is easy to apply directly from release paper rolls. Shelf life is virtually unlimited, as there is no adhesive coating to dry out. Provides temperature performance to 250°F (121°C).

CAT. NO.	COLOR	WIDTH	THICKNESS	FEET/ROLL	ROLLS/CASE
RT139	Black	1/2" (12 mm)	1/16" (1.6 mm)	75 (22.8 m)	22

Minimum order 22 rolls (1 case). Must order in increments of 22 rolls.



CRL Filament Tape

- Perfect for Sealing, Reinforcing, Holding, Strapping, Bundling, Securing, Shipping, Etc.
- Available in Three Widths
- Use Any Width of this Tape in the TD901 Filament Tape Dispenser



CRL Filament Tape is a reinforced strapping tape that firmly grabs without cutting into cartons or edges of soft materials. It is a high tensile strength tape that readily conforms to irregular shapes, and is quickly and easily dispensed by hand or with a dispenser. Unidirectional filaments reinforce the tape for strong tear resistance. It also resists curling, and adheres excellently to corrugated and other surfaces.

CAT. NO.	WIDTH	FEET/ROLL	ROLLS/CASE
898T12	1/2" (12 mm)	180 (54.8 m)	72
898T34	3/4" (19 mm)	180 (54.8 m)	48
898T1	1" (25 mm)	180 (54.8 m)	36

Sizes can be combined for quantity pricing.

CRL Carton Sealing Tape

- Extra Sticky for Ease of Application
- Easily Dispensed with Our TD902 Carton Sealing Tape Dispenser

CRL Carton Sealing Tape is a pressure-sensitive, premium grade clear polypropylene film that's used for sealing cartons, packages, etc. The 2" (51 mm) wide tape is extremely sticky, giving strong holding power to corrugated and other materials. It is very clear when applied, and is good for sealing labels on shipping cartons. The high tensile strength will help keep packages together when subjected to even the most abusive handling.

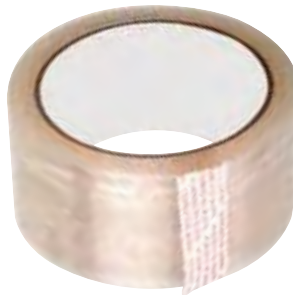

CAT. NO.	WIDTH	FEET/ROLL	ROLLS/CASE
3802	2" (51 mm)	165 (50.3 m)	36

CRL Tape Dispensers

Filament and Masking Tape Dispenser

- Holds Filament and Masking Tapes Up to 1" in Width



Tape Not Included

This CRL Filament and Masking Tape Dispenser speeds the dispensing of tape for most applications. Made of heavy gauge, bright finish steel, it has a high efficiency hand brace to regulate tape tension quickly and effectively. A sharp, serrated steel cutting blade cuts off the tape easily.

CAT. NO. TD901

Carton Sealing Tape Dispenser

- Made Especially for Dispensing 2" Carton Sealing Tape



Tape Not Included

Lightweight and compact, this CRL Carton Sealing Tape Dispenser is built to dispense our carton sealing tape quickly and efficiently. It comes with an adjustable brake to ensure smooth application. This is an indispensable tool for applying CRL Carton Sealing Tape.

CAT. NO. TD902

CRL Electrical Tape

- UL Approved
- 18 Month Shelf Life



Designed to insulate wire, pipes, dissimilar metals, etc., CRL Electrical Tape is resistant to weather, water, acids, alkalies, and oils. It has superior conformability and high elongation to give a tight, solid wrap. A silicone spray additive gives it an 18-month shelf life. It practically never telescopes or bleeds. The glossy black tape is 17 mils (.4 mm) thick.

CAT. NO.	WIDTH	FEET/ROLL	ROLLS/CASE
1ET314	3/4" (19 mm)	60 (18.2 m)	360

CRL 3M™ Very High Bond Manufacturing Tape

- Super Adhesive, High Bonding Strength Tape Can Replace Rivets, Screws, Spot Welds, and Liquid Adhesives
- Can be Used for Interior or Exterior Industrial Applications
- Bonds to Many Substrates

CRL 3M™ VHB™ Tape can replace mechanical fasteners such as rivets, spot welds, screws, and liquid adhesives. VHB™ Tape has successfully replaced all these and other fasteners in various manufacturing uses. It bonds to many substrates, and can be used for interior or exterior industrial applications. VHB™ Tape eliminates drilling for mechanical fasteners, and mixing of liquid adhesives. It applies neatly and easily, conforms to irregular surfaces, and allows concealment in use. Excellent resistance to ultraviolet light, solvents, moisture, and plasticizer migration.

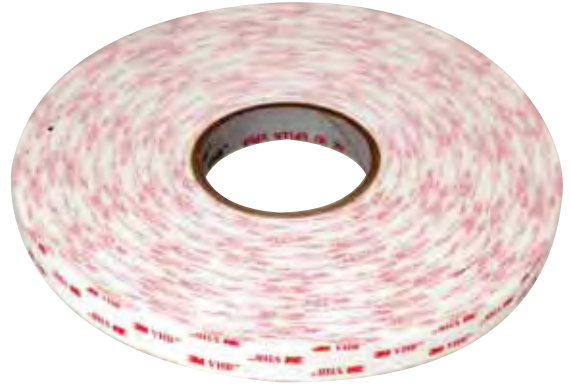

CAT. NO.	COLOR	WIDTH	THICKNESS	FEET/ROLL	ROLLS/CASE
494512	White	1/2"	.045"	108 (32.9 m)	18
494534	White	3/4"	.045"	108 (32.9 m)	12
49451	White	1"	.045"	108 (32.9 m)	9
49452	White	2"	.045"	108 (32.9 m)	6

All tapes on this page can be combined for quantity pricing.

CRL 3M™ Transparent and Translucent Adhesive Tapes

- Bonds to Most Clean, Dry Surfaces Instantly
- Full Strength Attained in 72 Hours
- Replaces Mechanical Fasteners in Many Applications



CAT. NO.	DESCRIPTION	WIDTH	THICKNESS	FEET/ROLL	ROLLS/CASE
491014	Transparent, VHB™ Double-Sided	1/4"	.040"	108 (32.9 m)	36
491012	Transparent, VHB™ Double-Sided	1/2"	.040"	108 (32.9 m)	18
490514	Transparent, VHB™ Double-Sided	1/4"	.020"	216 (65.8 m)	36
867238	Transparent, VHB™ Single-Sided	3/8"	.006"	108 (32.9 m)	24
SDT51660	Translucent, Double-Sided	5/16"	.005"	180 (54.8 m)	16

All tapes on this page can be combined for quantity pricing.

Transparent 3M™ VHB™ Double-Sided Adhesive Tape

Transparent 3M™ VHB™ (Very High Bond) Tape is a high strength double-sided adhesive. Available in 1/4" or 1/2" widths, this tape features instant bonding with full strength attained within 72 hours. You will find VHB™ Tape can be the clear replacement for mechanical fasteners in many instances.

Transparent 3M™ VHB™ Single-Sided Adhesive Tape

Transparent 3M™ VHB™ (Very High Bond) Tape is also available with adhesive on only one side. It is most commonly used as a cushion to protect against chipping in installations with glass-to-glass contact, such as frameless shower doors, or in glass display cases.

Translucent Double-Sided Adhesive Tape

Our Translucent Double-Sided Adhesive Tape is an economical alternative to higher priced Transparent Tapes. It is a good choice for adhering edge wipes and seals in frameless shower enclosures.

CRL Transparent and Translucent Acrylic Very Hi-Bond Adhesive Tapes

CRL Acrylic Double-Sided Very Hi-Bond Adhesive Tape is designed for a variety of applications including auto trim attachment, skin-to-frame assemblies, furniture, appliances, window grids, signs, graphics, construction uses to replace mechanical fasteners and welds, and whenever a waterproof bond in a wide range of temperature conditions exists.



CAT. NO.	DESCRIPTION	WIDTH	THICKNESS	FEET/ROLL	ROLLS/CASE
AT04012	Transparent	1/2"	.040"	108 (32.9 m)	24
AT0401236	Transparent	1/2"	.040"	36 (11 m)	36
AT04014	Transparent	1/4"	.040"	108 (32.9 m)	24
AT0401436	Transparent	1/4"	.040"	36 (11 m)	36
AT02014	Transparent	1/4"	.020"	216 (65.8 m)	24
AT0201436	Transparent	1/4"	.020"	36 (11 m)	36
AT04512	Translucent	1/2"	.040"	108 (32.9 m)	24
AT04534	Translucent	3/4"	.040"	108 (32.9 m)	14
AT0451	Translucent	1"	.040"	108 (32.9 m)	14
AT0452	Translucent	2"	.040"	108 (32.9 m)	8

All tapes on this page can be combined for quantity pricing.



CRL Kennedy 22" Cantilever Tool Box

- Our Most Popular Large Tool Box
- Top Quality Construction
- Plated Hardware for Longer Wear

CRL sells the Kennedy Tool Box line because we know hard working professionals deserve the highest quality available. These Kennedy Tool Boxes are made of sturdy steel, and are compartmentalized to organize tools, small parts, fasteners, fittings, and safety gear.

Features include: extremely durable brown wrinkle finish; locking hardware and side catches plated for extra long wear; vinyl cushioned steel core handle; stair step enamel painted trays made of steel; divided lid for opening ease. Put it all together and you've got a tool box with quality construction throughout. Measures 22-1/8" (562 mm) long by 10-1/16" (255 mm) wide by 12-5/8" (320 mm) high.



CAT. NO. 1022

CRL Kennedy 20" Tool Box and Toter Tray

- Removable Small Tool Carrying Tray
- Famous and Durable Kennedy Quality



CAT. NO. 5220

The Kennedy 20" Tool Box and Toter Tray is the practical way to store your small parts and tools for easy carrying. If you want an easy way to carry just a small assortment of tools that you want in order to complete that one job, just load up this tool tote and you are on your way. Features include: durable brown wrinkle finish; a folding polypropylene handle; plated locking hardware. Box measures 20-1/8" (511 mm) long by 7-1/8" (181 mm) wide by 7-5/16" (186 mm) high.

CRL Kennedy 18" Cantilever Tool Box

- Our Most Popular Medium Size Tool Box
- Top Quality Construction with Plated Hardware for Longer Wear



CAT. NO. 1018

These Kennedy Cantilever Tool Boxes are made of sturdy steel, and are compartmentalized to organize tools, small parts, fasteners, fittings, and safety gear. Features include: durable brown wrinkle finish; locking hardware and side catches plated for extra long wear; vinyl cushioned steel core handle; stair step enamel painted trays made of steel; divided lid for opening ease. Truly a tool box with quality construction throughout, it measures 18-1/8" (460 mm) long by 10-1/16" (255 mm) wide by 12-5/8" (320 mm) high.

CRL Kennedy Two Drawer Portable Tool Chest

- Popular New Style with Kennedy Quality Construction
- Two Smooth Operating Drawers

new

Conveniently portable, this Kennedy Two Drawer Tool Box is constructed of the finest quality material, and has the necessary storage space to hold both large and small tools. This good-looking tool box has a brown wrinkle finish, and smooth operating drawers that allow for organization of small parts or easily misplaced tools. Box measures 20-1/8" (511 mm) long by 8-5/8" (219 mm) wide by 9-3/4" (248 mm) high.



CAT. NO. 220K

CRL Kennedy Top Till Three Drawer Machinist's Chest

- Large Capacity Drawers
- Felt Lined for Quality Tool Storage

You can carry this heavy-duty Kennedy Top Till Three Drawer Machinist's Chest or just leave it on your workbench. It features eight wool felt lined drawers, plus it has a top compartment. It includes six adjustable drawer dividers, a cylinder lock with two keys, and a self-storing, drop front panel. The rugged side handles makes it easy to carry. Box measures 20-1/8" (511 mm) long by 8-9/16" (217 mm) wide by 13-5/8" (346 mm) high.



CAT. NO. 620

CRL Kennedy Top Till Seven Drawer Tool Chest

- Large Capacity Drawers
- Felt Lined for Quality Tool Storage



CAT. NO. 520

This sturdy, brown wrinkle finish Kennedy Tool Chest has seven drawers with six adjustable dividers. Each drawer and the top compartment are wool felt lined. The front panel conceals and locks the drawers when the lid closes, and stores in the base when not in use. Sturdy top handle and a cylinder lock with two keys round out the features of this quality built tool carrier. Measures 20-1/8" (511 mm) long by 8-9/16" (217 mm) wide by 13-5/8" (346 mm) high.

CRL Kennedy Top Till Machinist's Tool Chest

- Ruggedly Built with Large Capacity, Felt-Lined Drawers to Protect Your Valuable Tools



CAT. NO. 526

The eight drawers of the Kennedy Machinist's Tool Chest are lined to keep your valuable tools clean and protect against corrosion. Standard features include: durable brown wrinkle finish; six adjustable drawer dividers; a cylinder lock with two keys; self-storing, drop front panel. In addition, the rugged side handles on each of these chests make them easy to carry. Measures 26-11/16" (678 mm) long by 8-9/16" (217 mm) wide by 13-5/8" (346 mm) high.

CRL Kennedy Three Drawer Rolling Tool Box

- Heavy-Duty Steel Construction
- Easy Rolling, Large Capacity Box

This Kennedy Large Capacity Three Drawer Rolling Tool Box is a great place to store your large tools and supplies. It is made of heavy gauge steel, and has four 4" casters, two that lock in place, four dividers, and a cylinder lock with two keys. This durable brown wrinkle finish box measures 27" (686 mm) long by 20" (508 mm) wide by 35" (889 mm) high.



CAT. NO. 273

CRL Commercial Service Cart

- Large, Easy-Rolling 5" Casters
- 220 Pound Load Capacity

new

Our Commercial Service Carts are useful in the shop, the warehouse, or anywhere a sturdy, highly functional cart is needed. The Cart is equipped with heavy-duty 5" (127 mm) solid rubber casters - two swivel and two stationary - for easy portability and a stable work surface, and a convenient storage tray for your small tools. The working height is 32" (813 mm). The three trays measure 30" long (762 mm) by 16" wide (406 mm) by 3-1/2" deep (89 mm). Durable enamel finish. Easy to assemble.



CAT. NO. TC4104

CRL Small Parts Cabinets

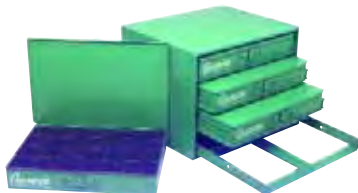

CAT. NO. AV496

This CRL Four Drawer Small Parts Cabinet with all four drawers installed will have 96 small parts compartments in which to hold your items. The small parts drawers are on easy slide trays. This unit is made of heavy gauge steel and is coated with a green enamel finish. It also features a pull handle and an index card holder for easy parts identification.



CAT. NO. AM11517

This CRL 15 Drawer Small Parts Cabinet is ideal for so many applications. It even includes a carrying handle for portability, and is self-stacking in case you need more than one cabinet. This unit is great for separating screws, nuts, clips, and bolts.

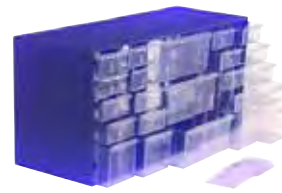

CAT. NO. AM11521

This CRL 23 Drawer Small Parts Cabinet has 23 assorted size drawers for separating small parts, fasteners, and other odds and ends. It has a carrying handle for portability, and is self-stacking so you can expand your storage space with additional cabinets.



CAT. NO. AM11450

This CRL 50 Drawer Small Parts Cabinet is large enough for most any application where you need lots of space for lots of different small items. Built-in carrying handle for portability, and can be stacked in case you need to use more than one cabinet.



CRL Deluxe Bucket Boss 35

- Fits Any Standard Five Gallon Bucket
- 35 Pockets: 24 Outside, 11 Inside
- Rugged 600 Denier Fabric



Bucket and Tools Shown with Bucket Boss Not Included

CAT. NO. BC1001

The CRL Deluxe Bucket Boss 35 turns any ordinary five gallon bucket into an organized tool carrier.

CRL Bucket Boss 24

- Economic Alternative to the Bucket Boss 35
- 24 Pockets: 17 Outside, 7 Inside
- Rugged 600 Denier Fabric



Bucket and Tools Shown with Bucket Boss Not Included

CAT. NO. BC1024

The CRL Bucket Boss 24 gives the same convenience as the Bucket Boss 35, but at a more economical price.

CRL Bucket Seat Pro

- Fits All Standard Five Gallon Buckets, Even with a Bucket Caddy in Place
- Seat, Parts Tray and Bucket Lid in One

The CRL Bucket Seat Pro is made of rugged polyethylene, and is equally useful as a cover, seat or parts tray. Simply place it on top of any five gallon plastic bucket so that it creates a great portable seat to work from. Six compartments organize fasteners, small tools and parts. Lid securely snaps closed.



Bucket Not Included

CAT. NO. BS2002

CRL Bucket Stacker

- Convenient Grab Handle for Easy Carrying
- Molded Trays with Separators to Keep Small Parts Organized

CRL Bucket Stackers are 2" (51 mm) deep injection molded trays divided into four separate compartments to hold fasteners, small parts, whatever. You can stack up to five stacker trays in your five gallon buckets to create an inexpensive and easy method of keeping your small items organized. Works great when paired with a Bucket Boss.



Bucket and Items Shown with Bucket Stacker Not Included



Example of Bucket Stacker and Items in a Bucket

CAT. NO. BC15011

CRL Parachute Bag

- Separates and Organizes Small Parts
- Automatically Closes When Lifted
- Flat Bottom Design Prevents Tipping

The CRL Parachute Bag has six compartments to hold your screws, nuts, bolts, sockets, or any small parts. This Khaki tan 600 Denier polyester bag will fill up to four deep in any standard five gallon bucket. Strung with authentic military parachute cord, the Parachute Bag keeps those small parts in plain sight for easy access.



Items in Bag Not Included



Example of Bag and Items in a Bucket

CAT. NO. PB5001

CRL 28 Pocket Electrical and Maintenance Tool Pouch

new

- 7" x 5" Multi-Compartment Plastic Tray
- Box-Shaped Design Prevents Tipping
- Pockets for Drill Bits

This 28 Pocket Tool Pouch has a multi-compartment plastic tray that slides securely into the bottom of the pouch. It has pockets for your hand tools, tape rule, drill bits, and other small items. Its box-shaped design prevents tipping.



Tools Not Included

CAT. NO. 1526

CRL Tool Basket

- Lightweight and Rugged Carrier for Tools and Supplies
- Measures a Big 16" x 10" x 10" Inside



Items In Basket Not Included

CAT. NO. WB33

The CRL Tool Basket is the handy way to carry your tools and supplies on the job. The folding handles make it very convenient to carry or store. See-through sides make it easy to see what is inside.

CRL Heavy-Duty Tool Carrying Bag

- Leather Bottom Panel
- Recessed Steel Frame



CAT. NO. M304

Our finest quality CRL Heavy-Duty Canvas Bag is light, strong, and has a recessed steel frame. It comes complete with a leather handle and billets that complete the top grade construction. This is a very versatile bag used for carrying certain tools that you would use on specific jobs, yet is not as heavy as a metal tool box. Ideal for glaziers, electricians, mechanics, and masons, it measures 20" (508 mm) long by 16" (406 mm) deep.

CRL Canvas Tool Bag

- Made of Extra Heavy Canvas
- Flat Bottom So It Can Stand Alone

This big, roomy CRL Canvas Tool Bag has a flat bottom and heavy-duty web strap handles. It can stand alone, and has two 9" (229 mm) by 14" (356 mm) utility pockets inside. It's triple sewn, and reinforced with rivets. You'll get a lot of use out of this heavy-duty bag.



CAT. NO. 100BAG

CRL Kwik-Change Front Loader Tool Box

- Three Removable Divided Containers That Slide Out for Easy Access

The CRL Kwik-Change Front Loader Tool Box features three removable and interchangeable containers for small parts and tools. There is also bulk storage space beneath the lid for larger tools and supplies, and an exterior rack on each side for small tool storage. Measures 20-1/2" (520 mm) by 12" (304 mm) by 14-1/2" (368 mm), and has a handle that recesses into the lid.



Tools Not Included
CAT. NO. 80200

CRL Six Pocket Tool Pouch

- Top Grain Leather
- Quick Release Tool Snap

This CRL Six Pocket Tool Pouch has six pockets for pliers, screwdrivers, etc. Features include: one large 6" (152 mm) main pocket with two tool slots; two pre-formed front pockets; two tapered side screwdriver holders; "T" chain tape holder; one tape rule pocket; quick release spring metal clamp for wrenches. Top grain leather with two 2-3/4" (70 mm) belt slots. Rivet reinforced for durability.



CAT. NO. MN438

CRL Seven Pocket Tool Pouch

- Top Grain Leather
- Rivet Reinforced

This CRL Seven Pocket Tool Pouch has extra tool capacity with seven pockets for pliers, screwdrivers, etc. Features include: one large 6" (152 mm) main flared pocket; three pre-formed front pockets; two tapered side screwdriver holders; "T" chain tape holder; leather hammer holder; and a quick release spring metal clamp for wrenches. Top grain leather with 2" (51 mm) tunnel belt loop. Rivet reinforced for durability.



CAT. NO. MN603



CRL 25' Ultimate Tape Rule

- Ergonomic Case for Exceptional Comfort and Secure Grip
- Ultra-Rigid 1" Wide Steel Blade with Large Easy-to-Read Numbers
- It's a Fist Full of Tape Rule!

This CRL Ultimate Tape has an innovative inline gear which allows it to fit perfectly in your hand for exceptional comfort and a secure grip. The nylon coated, 25 foot two-color blade has 16 inch stud markings and features a triple rivet hook connection. An active bumper protects both the blade and rivets from retraction shock ensuring long blade life.



CAT. NO.	BLADE WIDTH	BLADE LENGTH
54225	1" (25.4 mm)	25' (7.62 m)

CRL Power Tape Rules

- Professional Quality
- Ultra-Rigid Steel Blades, Positive Lock Button
- Two-Color Blade Markings

These CRL Power Tape Rules have an ergonomic case design with a molded rubber grip that provides for both user comfort and durability. Nylon coated, two-color blades have 16 inch stud markings and feature a triple rivet hook connection. An active bumper protects both the blade and rivets from retraction shock to ensure long blade life. Available in four popular lengths.

CAT. NO.	BLADE WIDTH	BLADE LENGTH
54112	5/8" (16 mm)	12' (3.65 m)
54116	3/4" (19 mm)	16' (4.88 m)
54125	1" (25.4 mm)	25' (7.62 m)
54133	1" (25.4 mm)	33' (10.05 m)

Sizes can be combined for quantity pricing.



CRL Single Edge Razor Blades

- Precision Honed, Surgical Steel Edges
- Each Blade is Individually Wrapped

This CRL Single Edge Razor Blade is top quality, industrial grade, surgical steel precision-honed for extra sharpness. It delivers durability along with the exacting quality cut that professionals demand. 100 Blades per box.



CAT. NO. 51S

CRL Heavy-Duty Razor Scraper

- Holds 51S Single Edge or CP866088 Plastic Razor Blades
- Comes with One Metal and One Plastic Blade



CAT. NO. CRL761

This CRL 11" Heavy-Duty Razor Scraper safely holds all single edge razor blades while scraping decals, stickers or other hard-to-remove items from windows or walls. Handle has a hollow center to hold extra metal or plastic razor blades.

CRL Scrape and Pry Bar

- Tempered Tool Steel
- Ideal for Pulling Nails, Prying, Lifting, Scraping, and Much More
- Our Most Popular Model



CAT. NO. 4050

The CRL Scrape and Pry Bar is a versatile tool made of the finest hardened, tempered tool steel. Both ends are chisel ground, 1-3/4" (44 mm) wide, for scraping or prying. One end has a 50 degree angle bend and nail puller hole. Our most popular model - just the right size for your tool box.

CRL Oil Type Glass Cutters

- Self Lubricating Wheel for Long Life
- Interchangeable Cutting Heads

Our Oil Type Glass Cutters let you cut glass in quantity without losing sharpness. Every time you depress the wheel it automatically dispenses a drop of cutting oil to the 134° steel cutting wheel. Choose either the metal handle or plastic handle model, both of which can be ordered with a straight cutting or pattern cutting head.

OIL TYPE CUTTERS

CAT. NO.	HANDLE	HONE ANGLE	DESCRIPTION
P1050	Plastic	134°	Straight Head
P1050D	Plastic	134°	Pattern Head
S1050	Metal	134°	Straight Head
S1050D	Metal	134°	Pattern Head

Oil Type Glass Cutters can be combined for quantity pricing.



Metal Handle with Straight Cutting Head



Plastic Handle with Pattern Cutting Head



41050
Straight Cutting Head



41050D
Pattern Cutting Head



41050R
Cutting Head for 1/2" to 1" Thick Glass

REPLACEMENT CUTTING HEADS

CAT. NO.	HONE ANGLE	HEAD DESCRIPTION
41050	134°	Straight Cutting
41050D	134°	Pattern Cutting
41050R	154°	For 1/2" to 1" Glass

Replacement Heads can be combined for quantity pricing.

CRL Self-Oiling Glass Cutters

- Automatic Oil Dispensing System
- Choice of Three Interchangeable Cutting Heads

The CRL Self-Oiling Glass Cutter is a performance tool for the professional glazier. Consistent glass cutting results are attributed to the interchangeable cutting heads which are available for pattern, straight, and thick glass cutting applications. The self-contained oil metering system allows a small amount of fluid to be delivered to the cutting wheel, adding service life to the tool. The transparent handle shows the level of cutting oil in the reservoir. Made in the U.S.A.



140° Pattern Cutting Head



140° Straight Cutting Head



154° Head for Thick Glass

CAT. NO.
OGC3P



CAT. NO. OGC1S

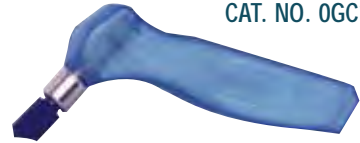

CAT. NO.
OGC4S



CAT. NO.
OGC5H



CUTTING HEADS

CAT. NO.	HONE ANGLE	HEAD DESCRIPTION
OGC3P	140°	Pattern Head
OGC4S	140°	Straight Cutting Head
OGC5H	154°	Head for Thick Glass

CAT. NO. OGC2G

CRL Heavy-Duty Oil Type Glass Cutter

- Molded Plastic Grip for Superior Control and Comfort
- Accepts Straight, Pattern or Thick Glass Cutting Heads

The pistol grip handle of these CRL Toyo Oil Type Glass Cutters is a reservoir for the cutting oil that is dispensed automatically every time the 134° steel cutting wheel makes a cut. Choose from straight or pattern cutting heads, which are easily interchangeable or replaced.

OIL TYPE CUTTERS

CAT. NO.	HANDLE	HONE ANGLE	DESCRIPTION
TC600P	Plastic	134°	Pattern Head
TC600S	Plastic	134°	Straight Head

Oil Type Glass Cutters can be combined for quantity pricing.



REPLACEMENT CUTTING HEADS

CAT. NO.	HONE ANGLE	HEAD DESCRIPTION
41050	134°	Straight Cutting
41050D	134°	Pattern Cutting
41050R	154°	For 1/2" to 1" Glass

Replacement Heads can be combined for quantity pricing.

CRL Toplife 2000 Deluxe Glass Cutter

- A New Dimension in Glass Cutting

The CRL Toplife 2000 Cutter has some unique features you won't find in other glass cutters. The cutting oil flow is controlled by two different systems. Fluid is dispensed only when the cutting head is depressed, minimizing leaks. Its fluid reservoir has a unique vented cap to regulate oil flow to the cutting head. The cutting head is mounted on a ball bearing axis so it can either be locked by a set screw to limit its rotation to 40°, or if the screw is released, the head can spin a full 360° for use with a cutting template. Interchangeable Wheel Holders are available for hone angles to accommodate glass in varying thicknesses from 3/32" to 3/4" (2 to 19 mm).



Wheel Holder

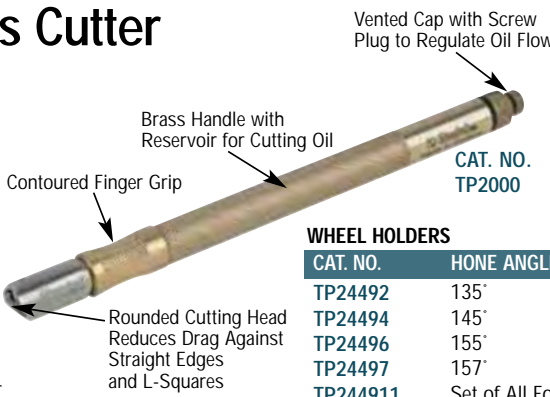

Vented Cap with Screw Plug to Regulate Oil Flow

Brass Handle with Reservoir for Cutting Oil

Contoured Finger Grip

Rounded Cutting Head Reduces Drag Against Straight Edges and L-Squares

Self Aligning Wheel Holder

CAT. NO.
TP2000

WHEEL HOLDERS

CAT. NO.	HONE ANGLE	GLASS THICKNESS
TP24492	135°	3/32"-1/4" (2-6 mm)
TP24494	145°	1/4"-3/8" (6-10 mm)
TP24496	155°	1/4"-5/8" (6-15 mm)
TP24497	157°	3/8"-3/4" (10-19 mm)
TP244911	Set of All Four Wheel Holders	



LOG ON TO crlaurence.com FOR BUSINESS-TO-BUSINESS SERVICES

A354 | PHONE (800) 421-6144 | FAX (800) 262-3299 TOLL FREE FROM ANYWHERE IN THE U.S.A. OR CANADA

CRL Glass Cutter and Pencil Pouch

- Made from Top Quality Leather
- Strap for Tape Measure or Pliers

This CRL Glass Cutter and Pencil Pouch is one of our most popular items. The leather pouch has three pockets to hold your pens, pencils or glass cutters. In addition, a leather strap has been added to hold a measuring tape or pliers. The large top belt loop will fit belts up to 1-1/2" (38 mm) wide.



CAT. NO. S5403

CRL Wood Handle Glass Cutters

- A Great Tool for General Purpose Cutting
- Precision Steel Wheel



CAT. NO. 022

The CRL Wood Handle Glass Cutter is a great all-purpose cutter for everyday cutting. The solid wood handle provides a comfortable grip. The precision ground 122 degree steel cutting wheel is perfect for general purpose and pattern glass cutting. There are three notches in the head of the cutter to allow nibbling in thinner glass. Nickel plated to resist corrosion.

CRL Fletcher® Gold Tip Ball End General Purpose Glass Cutters

- 120° Hone Angle
- "Classic" Ball End Design



CAT. NO. 02

The CRL Fletcher 02 Glass Cutter is widely used in the glass industry. It has a ball end handle that is very popular with professional glaziers, and features a 120 degree hone angle wheel with a phosphor bronze axle. The finest known bearing for glass cutter wheels. Sold only in dozens, each cutter is individually boxed for protection.

CRL Ball End Metal Handle Glass Cutters

- High Quality, Precision Steel Wheel
- Preferred Ball End Design



CAT. NO. 202

Our CRL Professional Ball End Metal Handle Glass Cutter incorporates the industry preferred all metal handle with a ball end. The outstanding features of the CRL 202 Glass Cutter include: a precision machined 7/32" (5.5 mm) diameter steel cutting wheel expertly honed for the highest cutting results, three different size breaking grooves, and a comfortably contoured streamlined metal handle with a ball tip. Sold only in dozens.

CRL Diamantor Wood Handle Glass Cutters

- Popular Import Glass Cutter
- Comfortable Wood Handle



This cutter is a long time favorite among glazing professionals. The CRL Diamantor Wood Handle Glass Cutter features a precision ground steel cutting wheel set into a nickel plated cutting head which is attached to a solid wood handle. There are also three breakout notches in the cutting head. A dependable, lightweight glass cutter for everyday use. Sold only in dozens.



CAT. NO. 2001

CRL Fletcher® Gold Tip Straight End General Purpose Glass Cutters

- 120° Hone Angle
- Popular Straight End Design

The CRL Fletcher 01 Glass Cutter has a straight handle and features a 120 degree hone angle wheel with a phosphor bronze axle. This cutter is very popular with professional glaziers, and is widely used throughout the industry. Sold only in dozens, each cutter is individually boxed for protection.



CAT. NO. 01

CRL Fletcher® General Purpose Carbide Wheel Glass Cutters

- Designed for General Purpose as Well as Production Glass Cutting
- Far Outlasts Steel Wheel Cutters

These CRL Fletcher Carbide Wheel Glass Cutters have tungsten carbide wheels that will far outlast and outperform glass cutters with steel wheels. Sold individually, they're an excellent choice for production use, and you have a choice of hone angles and handle styles.



CAT. NO.	DESCRIPTION
CA2124	Ball End General Purpose Cutter
CA1124	Straight End General Purpose Cutter
CA1114	Straight End Hard Glass Cutter
CA1134	Ball End Thick Float Glass Cutter

CRL Drop Jaw Glass Pliers

- For Glass Up to 1/2" (12 mm) Thick



CAT. NO. RD1932

The RD1932's precision ground jaws support the glass while developing powerful leverage under slight pressure to cleanly sever glass to the score line. 8-1/2" overall length.

CRL Flare Jaw Glass Pliers

- Machined Jaws for Consistent Breaks



CAT. NO. RD1935

The RD1935's jaws are machined with great attention to the tips to be sure that there is no gap between them when closed, ensuring that they are perfectly parallel. That means cleaner, more consistent breaks for you. 8-1/2" overall length.

CRL Flexible Shape Templates

- Immediate Copying and Cutting of the Same Shape in



CAT. NO. FST1

With CRL Flexible Shape Templates, copying and cutting irregular shapes is no longer a "guessing game". These Templates consist of a flexible metal band connected to individual metal segments. The segments are joined by wingnuts which, when tightened, hold the Template in it's desired shape. Suction cups fasten to these segments, holding it in place while cutting. Great for cutting arched entryways, windows, railings, and escalator glass.

CAT. NO.	DESCRIPTION
FST1	35" (900 mm) Template w/3 Cups
FST2	70" (1800 mm) Template w/4 Cups
STH670	Replacement Suction Cups

CRL Glass Cutter Oil

- For Use with All Oil Glass Cutters

CRL Professional Glass Cutter Oil is designed for general oil-fed glass cutters, as well as production glass cutting machines. Cutting oil extends wheel life and helps to make cleaner cuts. Available in five sizes: Four Ounce (118 ml), Quart (946 ml), Gallon (3.785 liter), Five Gallon (18.93 liter), and 55 Gallon (208.20 liter) containers.



CAT. NO. W4104
4 Ounces



CAT. NO. W410QT
Quart



CAT. NO. W410GL
Gallon

CRL Glass Running Pliers

- Lightweight and Portable
- Plastic Jaws Won't Chip Glass



CAT. NO. GRP512

Finally a glass plier that is both lightweight and durable. The new GRP512 Glass Running Pliers are an excellent addition to any glazier's tool box. These all aluminum pliers have a noticeably different and very comfortable feel to them the first time you pick them up. The high density plastic jaws will not chip or mar your glass like steel jaw pliers. Runs score lines in glass and mirror from 1/8" to 3/8" (3 mm to 10 mm) thick. They fit easily in a cutter pouch or in your pocket, and are light enough to carry around all day. Built to last, they will never rust. Overall length is 8-1/2".

CRL Round Edge Template Guide

- Make Consistent Radius Corners Easier Than Ever
- Choose from 12 Radii (10 to 70 mm)
- Slip Resistant Rubber Pads



CAT. NO. RET12

The CRL Round Edge Template Guide gives you 12 radii (10 to 70 mm) to pick from to allow you to score precise, repetitious cuts for table tops, shelves, automotive glass, mirrors and more. Manufactured in a tough, durable material, the RET12 features four rubber slip resistant pads that not only keep the Template in place during use, but also reduces the risk of scratching the glass.

CRL Glass Slicker

- Deposits Thin Film of Oil on Glass
- Aids in Cleaner, Smoother Cut and Break



CAT. NO. GLS1



Our Glass Slicker is an innovative and inexpensive way to increase productivity and prolong cutter life. By drawing the Glass Slicker along the straight edge, the glass is wiped clean. At the same time, a thin film of oil is deposited on the glass. This helps to prevent "hot cuts" and skips, resulting in a cleaner, smoother cut and break. The Glass Slicker is impregnated with light oil and can be refilled with CRL W410 Cutting Oil. Also used to lubricate panic hardware, hinge pins or other hardware.



CRL Mirror and Glass Notching Saw

- Battery Powered - Completely Self-Contained
- Makes Plunge Cuts and Edge Cuts
- Refillable Coolant Canister

The CRL NS3000 Mirror and Glass Notching Saw Kit was developed exclusively for the glass industry. The NS3B Diamond Blade (sold separately) is perfect for glass and mirror up to 3/4" (19 mm) thick, and can be used to make edge or plunge cuts, so corner notches or outlet plate cut-outs can be made with similar ease and convenience. The 7249508C Diamond Tile Cutting Blade (included) increases the tool's versatility. The blades can be changed quickly and easily, requiring the loosening of only one bolt. By keeping an extra Battery Cartridge charged and on hand, you can work virtually non-stop. And since it is cordless, you can take the NS3000 almost anywhere, and never have to worry about where you'll plug it in.

NOTE: Always use with a proper solution of Diamond Tool Coolant. Never Cut Dry!

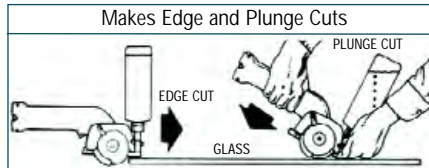

Standard Equipment Includes:

Rechargeable battery cartridge, battery charger, blade wrench, 3-3/8" combination blade. Full instructions for use included.

CAT. NO. NS3000

REPLACEMENT BLADES AND ACCESSORIES

CAT. NO.	DESCRIPTION
NS3B	Diamond Smooth Cut Glass Blade
7249508C	Diamond Tile Cutting Blade
DTC80Z	8 Oz. Diamond Tool Coolant
1131032	9.6 Volt Battery Charger
6320074	9.6 Volt Nickel-Cadmium Battery Cartridge

CRL Phenolic "L" Squares

- Factory Calibrated for Accuracy

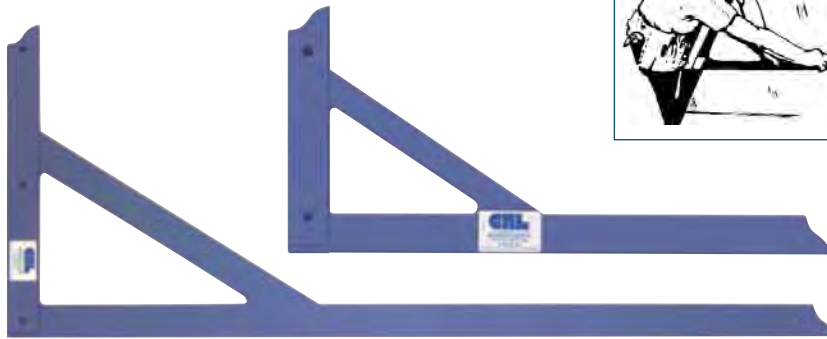

These inexpensive, durable CRL "L" Squares really do the job. Because they are made of high impact phenolic, they take a lot of on-the-job punishment without warping, and last a long time.

INDIVIDUAL "L" SQUARES

CAT. NO.	SIZE
L24	24" (609 mm)
L36	36" (914 mm)
L48	48" (1.22 m)
L60*	60" (1.52 m)

*Over UPS size limits. Shipped motor freight only.

CRL Phenolic Straight Edges

- Built to Last
- Won't Warp Like Wood

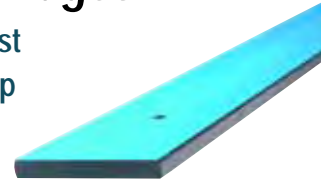

These tough Phenolic Straight Edges are built to last. They have no markings, but are accurate and easy to use. Used by leading glass companies, these high quality straight edges are valuable tools wherever glass is cut. All Straight Edges measure 3" wide by 7/16" (76.2 mm by 11.1 mm) thick.

CAT. NO.	LENGTH
SEP48	48" (1.22 m)
SEP72	72" (1.83 m)
SEP96	96" (2.44 m)
SEP120*	120" (3.05 m)
SEP144*	144" (3.65 m)

*Over UPS size limits. Shipped motor freight only.

CRL Grip Strip Tape

- Stops Straight Edge Slipping



CAT. NO. GG1225

CRL Grip Strip is a unique, self-adhesive tape you apply to your Straight Edges and L-Squares to keep them from slipping on your glass while cutting. It grips the glass but will not stick to it or leave messy residue. Reduce scratches and cutting mistakes. Quick and easy to apply, and comes on release paper rolls. 25 feet (7.62 m) per roll.

CRL Yellow Glass Marking Pencil

- Our Most Popular Glass Marking Pencil
- Bright, Stand-Out Yellow Color



CAT. NO. GM44

CRL Yellow Glass Marking Pencils are great for marking on glass, acrylics, marble, tile, etc. They sharpen to a precise point, and their high visibility yellow color makes them ideal for all marking purposes. Great for labeling stock and making measured cuts. Marks easily rub clean with a dry cloth. 12 per box.

CRL Stabilo Pens



- Designed for Marking on Glass
- Quick Drying Permanent Ink

CRL Stabilo Marking Pens are designed expressly for marking on glass. They are quick drying and easy to read because of the broader soft tip. Marks will not rub off under normal contact, but can be removed if necessary. Also great for marking cut lines or patterns on stained glass. 12 per box.



CAT. NO.	COLOR
76P40	Red
76P46	Black

Colors can be combined for quantity pricing.

CRL Makita 1-1/8" x 21" Belt Sander

- Extremely Popular Portable Sander for Sanding Notches and Cut-Outs

The CRL Makita 1-1/8" x 21" Belt Sander is compact and lightweight for close quarter work with excellent maneuverability for sanding irregular openings or shapes. The 4.2 amp motor drives the belt from 656 to 3,280 feet (200 to 1,000 meters) per minute for maximum performance. Multi-position side handle lets you maneuver it with less operator fatigue. Comes with 10 Abrasive Belts (two each of five different grits). Go to crlaurence.com for specifications.



CAT. NO. 9031M

CRL Makita 3/8" x 21" Belt Sander

- Great for Small, Confined Areas
- Adjustable Sanding Arm
- Electronic Speed Control

The CRL Makita 3/8" x 21" Belt Sander makes polishing notches and corners a breeze. Tight spaces no longer limit your ability to produce a quality edge. The sanding arm pivots a full 100° for the ease of operation, while providing balance and high performance at any position. The electronically controlled motor provides sanding speeds from 980 to 5600 feet (298 to 1707 meters) per minute for precision sanding and polishing in any position, and on any material thickness. There is also an easy quick-release lever for changing the Abrasive Belts. A belt-tracking knob is conveniently located for fine adjustment of the belt, and no tools are needed for any of the adjustments. Go to crlaurence.com for specifications.



CAT. NO. 9032

CRL Makita 3" x 21" Belt Sander

- Double Insulated
- Sands Cleanly with Dust Collector
- Lever Control for Belt Replacement

This highly portable CRL Makita 3" x 21" Belt Sander is lightweight and easy to maneuver. Powerful 7.8 amp motor drives the belt at 1180 feet (360 meters) per minute for fast and even belt tracking. Features include an efficient dust collector, lock-on switch, extra long power cord, and flush-to-wall standard design. Comes with one Abrasive Belt (100 grit) and Dust Bag. Go to crlaurence.com for specifications.



CAT. NO. 9903



CRL Makita 3" x 24" Belt Sander

- **Fast Sanding Belt Speed with Lever Control for Quick Belt Change**
- **Powerful 7.8 Amp Motor**

One of our most popular sanders, the CRL Makita 9924DB uses any 3" x 24" abrasive or polishing belt. Lever control allows belts to be changed easily and quickly. The 7.8 amp motor drives the belt at 1,300 feet (396 meters) per minute. Light enough to be easily maneuvered, yet sturdy enough for production or job site use. Unique design allows flush to wall sanding. Fine adjust tracking mechanism ensures proper belt tension. Externally accessible motor brushes for easy maintenance. Comes with one Abrasive Belt (100 grit) and Dust Bag. Go to crlaurence.com for specifications.



CAT. NO. 9924DB

CRL Makita 4" x 24" Belt Sander

- **33 Percent More Sanding Surface Than 3" Models**
- **Extra Powerful 8.5 Amp Motor**

This extra wide 4" x 24" CRL Makita Belt Sander has 33 percent more sanding surface than 3" x 24" models, so it removes stock quicker. The big 8.5 amp motor drives the belt at 1,148 feet (350 meters) per minute. The multi-groove V-belt gives the improved power transmission you need for heavy production use. It's designed for flush sanding and is well balanced with a low center of gravity for better control. Built-in dust bag for clean convenience. Comes with one Abrasive Belt (100 grit). Go to crlaurence.com for specifications.



CAT. NO. 9403

CRL 4" x 64" Bench Model Belt Sander

- **An Extremely Mobile Unit That is Ideal for Bench Top or Truck Bed**
- **Heavy-Duty One HP Single Phase 110 Volt AC Motor**

This CRL Bench Model Belt Sander uses all standard 4" x 64" Wet or Dry Abrasive Belts, and is specifically designed for use in the shop or on the job site. It's perfect for bench work where there is only a limited need for edge-work capacity. This sander can also be mounted right onto a glass truck for rough grinding, smoothing and polishing the edges of glass on a job site. Water for wet grinding sprays on the back of the belt from a built-in spray nozzle connected to a built-in water tank. Just pour water in the holding tank and you can wet grind anywhere. Requires 115V AC and should be used with the CRL GF1 Ground Fault Circuit Interrupt Device. Go to crlaurence.com for specifications.



CAT. NO. 100BM



CRL Glass Grinding Belts for Portable Sanders



• Six Popular Sizes

CRL Glass Grinding Belts for portable sanders are now an even better deal because of more cost-efficient, space-saving packaging. You get the same high quality at a lower overall price per belt. Six standard sizes in grits from 36X (Extra Coarse) to 600X (Super Fine) on a 100% polyester backing. Cork Polishing Belts are also available (see page A364).

- Tough, Fast Grinding, and Long Lasting Polyester Backed Belts
- Stock Sizes from 36X to 600X Grit (Plus Special Order Sizes) to Fit Virtually All Portable Belt Sanders
- Cost-Efficient Packaging and Manufacturing Techniques Let Us Give You Better Value in All Sizes and Grits
- All Sizes and Grits Can Be Combined for Quantity Pricing
- All Sizes Packed 10 Per Box (Except 3/8" X 21")

Most Popular Grits and Their Uses:

- 60X:** Extra Rough, for removing glass fast. Example: Mitered edge.
- 80X:** Rough, for quick contouring. Example: Auto glass edge.
- 120X:** Smooth, for seaming and polishing. Example: Desktop edge.
- 220X:** Extra Smooth, for fine frost finish. Example: Glass shelf edge.
- 400X:** Fine, for satin finish. Example: Opaque edge.
- CORK:** Polish: Smooth Luster Finish.

3" X 24" SIZE

CAT. NO.	GRIT
CRL3X2436X	36X
CRL3X2440X	40X
CRL3X2450X	50X
CRL3X2460X	60X
CRL3X2480X	80X
CRL3X24100X	100X
CRL3X24120X	120X
CRL3X24150X	150X
CRL3X24180X	180X
CRL3X24220X	220X
CRL3X24320X	320X
CRL3X24400X	400X
CRL3X24600X	600X
CRL3X24CORK	CORK

All Cork Belts sold one per box.

1-1/8" X 21" SIZE

CAT. NO.	GRIT
CRL118X2160X	60X
CRL118X2180X	80X
CRL118X21120X	120X
CRL118X21220X	220X
CRL118X21400X	400X
CRL118X21600X	600X
CRL118X21CORK	CORK

3" X 18" SIZE

CAT. NO.	GRIT
CRL3X1860X	60X
CRL3X1880X	80X
CRL3X18120X	120X
CRL3X18220X	220X
CRL3X18400X	400X
CRL3X18CORK	CORK

3" X 21" SIZE

CAT. NO.	GRIT
CRL3X2160X	60X
CRL3X2180X	80X
CRL3X21120X	120X
CRL3X21220X	220X
CRL3X21400X	400X
CRL3X21600X	600X
CRL3X21CORK	CORK



NEW 3/8" X 21" SIZE

CAT. NO.	GRIT
CRL38X2160X	60X
CRL38X2180X	80X
CRL38X21120X	120X
CRL38X21220X	220X
CRL38X21400X	400X
CRL38X21CORK	CORK

All grits packed 20 per box, except Cork at 5 per box.

CRL Polishing Oil

- Spray on Belts and Discs for Faster, Brighter Polishing
- Promotes Longer Belt Life

Spray CRL Polishing Oil on your abrasive belts and discs to keep them soft and free cutting. Helps to reduce "loading" while it improves finish edges on metal and glass. Net weight is 11 ounces (312 g). 12 per case.



CAT. NO. CRL920

CRL Tube Wax Lubricant

- Improves Finish and Performance While Sanding and Grinding



CRL Tube Wax Lubricant is a special formulation of solid waxes that comes in a convenient, soft stick. Use it for all sanding, grinding, drilling, tapping, sawing, and fastening operations to increase production quality and improve tool life. Neat and easy to use, requiring no special storage or handling. Net weight is 15 ounces (425 g). 24 per case.

CAT. NO. WS140



LOG ON TO crlaurence.com FOR BUSINESS-TO-BUSINESS SERVICES

A360 | PHONE (800) 421-6144 | FAX (800) 262-3299 TOLL FREE FROM ANYWHERE IN THE U.S.A. OR CANADA

CRL Wet Abrasive Belts for Upright Belt Sanders



- All Sizes Packed Five of One Grit Per Box
- Stock Sizes from 36X to 600X Grit (Plus Special Order Sizes) to Fit Virtually All Upright Belt Sanders

CRL Wet Abrasive Belts have a 100% polyester backing, so you can use them wet or dry. Available in six standard sizes in grits from 36X (Extra Coarse) to 600X (Super Fine) to fit most any upright belt sanding machine, such as our 2200RP and GL4W Upright Sanders (see page A362), or our 100BM Bench Model Sander (see page A359).



4" X 106" SIZE		4" X 64" SIZE		4" X 82" SIZE		MSDS		
CAT. NO.	GRIT	CAT. NO.	GRIT	CAT. NO.	GRIT			
CRL4X10636X	36X	CRL4X6460X	60X	CRL4X8260X	60X			
CRL4X10640X	40X	CRL4X6480X	80X	CRL4X8280X	80X			
CRL4X10650X	50X	CRL4X64120X	120X	CRL4X82120X	120X			
CRL4X10660X	60X	CRL4X64220X	220X	CRL4X82220X	220X			
CRL4X10680X	80X	CRL4X64400X	400X	CRL4X82400X	400X			
CRL4X106100X	100X	CRL4X64CORK	CORK	CRL4X82CORK	CORK			
CRL4X106120X	120X							
CRL4X106150X	150X	4" X 84" SIZE		4" X 118" SIZE			4" X 132" SIZE	
CRL4X106180X	180X	CAT. NO.	GRIT	CAT. NO.	GRIT		CAT. NO.	GRIT
CRL4X106220X	220X	CRL4X8460X	60X	CRL4X11860X	60X		CRL4X13260X	60X
CRL4X106320X	320X	CRL4X8480X	80X	CRL4X11880X	80X		CRL4X13280X	80X
CRL4X106400X	400X	CRL4X84120X	120X	CRL4X118120X	120X		CRL4X132120X	120X
CRL4X106600X	600X	CRL4X84220X	220X	CRL4X118220X	220X		CRL4X132220X	220X
CRL4X106CORK	CORK	CRL4X84400X	400X	CRL4X118400X	400X		CRL4X132400X	400X
		CRL4X84CORK	CORK	CRL4X118CORK	CORK		CRL4X132CORK	CORK

All Cork Belts sold one per box.

Most Popular Grits and Their Uses:

- 60X:** Extra Rough, for removing glass fast. Example: Mitered edge.
- 80X:** Rough, for quick contouring. Example: Auto glass edge.
- 120X:** Smooth, for seaming and polishing. Example: Desktop edge.
- 220X:** Extra Smooth, for fine frost finish. Example: Glass shelf edge.
- 400X:** Fine, for satin finish. Example: Opaque edge.
- CORK:** Polish: Smooth Luster Finish.

Large User Abrasive Program

- Save Big When You Buy in Bulk

If you use lots of abrasive belts and discs, CRL has a bulk quantity program that can really cut your costs. Bulk packed belts and discs require less packaging, therefore cost less to produce. We pass these savings on to big users at prices you'll find hard to beat.



All sizes and grits can be quoted in bulk, including any we don't normally stock. If you need them, CRL can deliver them. Please contact CRL Technical Sales by e-mail at techsales@crlaurence.com for pricing and details on our bulk abrasive program.

Custom Size and Grit Abrasives

- If You Need It, CRL Can Supply It

CRL can meet virtually all of your needs for Belts, Discs, Sheets, Pads, and other abrasive products. Let us quote prices on the abrasives your business uses. You supply the measurements (Fractional or Metric), grit sizes, backing type, and approximate quantities required. We will quote prices you'll find very competitive.



If you're not sure of the right abrasive to do a particular job, we can supply the technical expertise to make selection easier. We can also make delivery arrangements to meet the demands of Just-In-Time manufacturing schedules. Please contact CRL Technical Sales by e-mail at techsales@crlaurence.com for details and pricing on custom size and grit abrasives.

CRL 4" x 106" Upright Wet Belt Sander

- Rugged Construction and 1 H.P. Direct-Drive Motor Makes This Our Most Popular Belt Machine Ever
- Complete with Roller Platen, Front Rest Guide Roller Bar, Belt Guard Safety Shield, and Rust-Resistant Fiberglass Water Tank
- Uses Industry Standard 4" x 106" Abrasive Belts

Streamlined styling, rugged construction and an affordable price make the CRL Upright Wet Belt Sander ideal for use by glass fabricators and processors. The CRL Wet Belt Sander is designed to use popular size 4" x 106" wet or dry abrasive belts to sand edges to the desired finish. Available grits are 36X Super Coarse to 600X Super Fine, and Cork Polishing (see page A361). The 2200RP comes with a urethane covered Roller Platen and a Front Rest Roller Guide Bar. The 2200 comes with a PA100 Platen Adapter, which allows the addition of glass edging accessories. Both models feature our 2200SS Belt Guard Safety Shield.

Features of the Model 2200RP Include:

- Direct Drive, One H.P., 60 Cycle, 110 Volt AC Motor
- Five Inch (127 mm) Diameter Drive Pulley
- Fast Belt Changing Mechanism
- Durable Urethane Covered Roller Platen*
- Front Rest Roller Guide Bar*
- Belt Guard Safety Shield
- Electric Water Valve
- Non-Rusting Fiberglass Water Tank
- * Not included on Model 2200

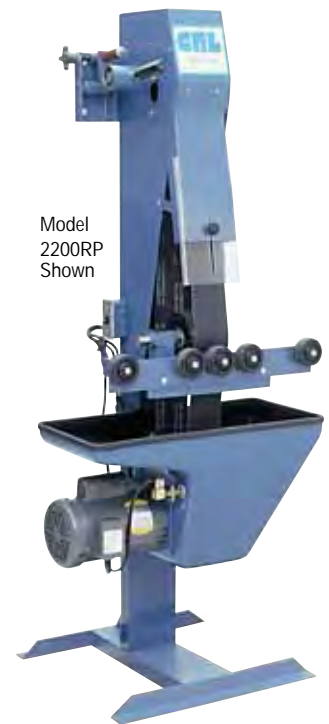

Model
2200RP
Shown

Machines are also available wired for 220 Volts.
For more information, or for machine specifications,
visit our web site at crlaurence.com.

CAT. NO.	DESCRIPTION
2200RP	Belt Sander with Roller Platen and Guide Bar
2200	Belt Sander without Roller Platen and Guide Bar

F.O.B. CRL warehouses. Must ship motor freight.

CRL 4" x 106" Upright Wet Belt Sander

- The Newest Addition to CRL's Wet Belt Sander Line
- Built-In Roller Platen and Easy Belt Changing System

The CRL 4" x 106" Wet Belt Sander is a rugged glass working machine. Built for use in production shops, the GL4W delivers high volume usage with very little periodic maintenance and virtually no scheduled service. All parts are carefully machined and balanced to ensure smooth, quiet operation.

The GL4W has five built-in rollers at the front of the tank to act as a rest for your glass while sanding. The built-in automatic water spray system removes all harmful glass dust particles before they can become airborne.

Belt tension and tracking is maintained by a unique upper bracket assembly which allows the sanding belt to run dead center on the two massive steel pulleys. Industry standard 4" x 106" abrasive belts can be changed in a matter of seconds.

Powered by a One H.P., 115/230 Volt, 3450 RPM, Single Phase industrial motor, the GL4W has more than ample power for your high production sanding needs. Includes Belt Guard Safety Shield.



Model
GL4W
Shown

For more information, or for machine specifications,
visit our web site at crlaurence.com.

CAT. NO.	DESCRIPTION
GL4W	4" x 106" Upright Wet Belt Sander (U.S. Model)
CN4106	4" x 106" Upright Wet Belt Sander (Canadian Model)

F.O.B. CRL warehouses. Must ship motor freight.

CRL POWR Edger

- Single Spindle Edger for 1/8" to 1/2" (3 to 12 mm) Glass
- Diamond Flat and Seam Wheel, Plus a Polishing Wheel Are Included
- Very Affordable Purchase or Lease Programs

Go to crlaurence.com for more details on this efficient and affordable edging machine that is right for so many shops. Not sure if the POWR Edger is right for you? Contact CRL Technical Sales to discuss how this machine's capabilities and specifications can benefit your business.

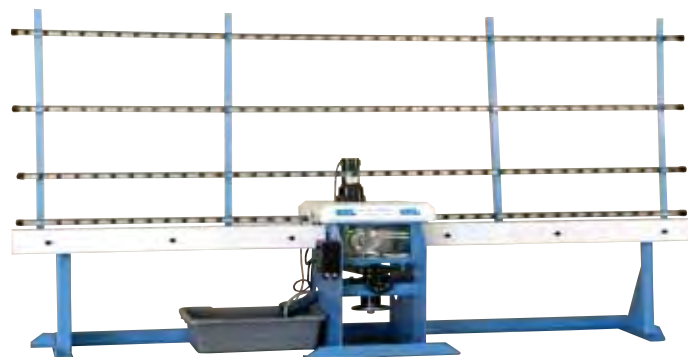

CAT. NO. PE11



LOG ON TO crlaurence.com FOR BUSINESS-TO-BUSINESS SERVICES

A362 | PHONE (800) 421-6144 | FAX (800) 262-3299 TOLL FREE FROM ANYWHERE IN THE U.S.A. OR CANADA

CRL Makita 5" Disc Sander

- Powerful 3.6 AMP Motor
- 4,500 RPM for Fast and Efficient Sanding



CAT. NO. GV5000

This CRL Makita 5" Disc Sander is a compact, lightweight tool for sanding and polishing. It has a powerful, double insulated 3.6 amp motor that delivers 4,500 RPM for fast and efficient sanding. Weighs only 2.6 pounds for easy handling, with a motor over the pad design for better balance and control. Ball and needle bearing is sealed against dust, as is the switch, for long tool life. Includes lock-on button for continuous operation. Standard Equipment: Sander, Plastic Pad, Hex Wrench, Side Handle and one 80 grit Sanding Disc. Perfect for use with our 5" Stick-On Sanding Discs (see below).

CRL Makita 7" Disc Sander-Polisher

- Double Insulated 7.9 AMP Motor
- Quick-Flip™ Speed Change
- Selection Button: Low (600 RPM) and Variable (600 - 2,000 RPM)



CAT. NO. PV7001C

The CRL Makita 7" Disc Sander-Polisher is a compact, lightweight tool for sanding and polishing. It has a powerful, double insulated 7.9 amp burnout protected motor with a maximum speed of 2,000 RPM. A Quick-Flip™ Speed Change Button lets you choose two speed settings: Low (600 RPM), and Variable (600 to 2,000 RPM). The ball and needle bearings and the switch are sealed to protect against dust. Standard Equipment: Sander-Polisher, Hook-and-Loop Back-Up Rubber Pad, Air Deflector, Spanner Wrench and Side Handle. Can be used with our 7" Stick-On Sanding Discs or 7" x 7/8" Sanding Discs (see below).

CRL Sanding Discs

- Silicon Carbide Discs Give You Excellent Sanding Performance Wet or Dry
- 6" and 7" Sizes to Fit Most Popular Brands of Disc Sanders

Our Silicon Carbide Sanding Discs come in 6" and 7" diameters to fit most popular brands of disc sanders. They have a 100% polyester backing that lets you use them wet or dry. Available in five grits: 60X (Extra Rough); 80X (Rough); 120X (Smooth); 220X (Extra Smooth); 400X (Fine), they come 50 discs per box. Minimum order is 50 discs of one grit and size.



- Five Stock Grits from 60X to 400X

CAT. NO.	SIZE*	GRIT
6X7860CB	6" x 7/8"	60X
6X7880CB	6" x 7/8"	80X
6X78120CB	6" x 7/8"	120X
6X78220CB	6" x 7/8"	220X
6X78400CB	6" x 7/8"	400X
7X7860CB	7" x 7/8"	60X
7X7880CB	7" x 7/8"	80X
7X78120CB	7" x 7/8"	120X
7X78220CB	7" x 7/8"	220X
7X78400CB	7" x 7/8"	400X

All sizes and grits may be combined for quantity pricing. *Size is defined as overall diameter and center hole size.

CRL Stick-On Sanding Discs and Backup Pads

- Pressure Sensitive Adhesive Saves Time and Labor
- Choice of Up to Five Grits in Three Sizes: 5", 6", and 7"

CRL Stick-On Sanding Discs with pressure sensitive adhesive are 100% polyester waterproof material. Made with high quality silicon carbide grain, these discs provide savings where it counts most, time and labor. Simply peel off the lining and stick the disc on your backup pad. Up to five popular grits are stocked. Grits ranging from 24X to 400X are available on special order.



(Sander Not Included)

STICK-ON SANDING DISCS

CAT. NO.	SIZE	GRIT
PSA560	5"	60X
PSA580	5"	80X
PSA5120	5"	120X
PSA5220	5"	220X
PSA5400	5"	400X
PSA660	6"	60X
PSA680	6"	80X
PSA6120	6"	120X
PSA6220	6"	220X
PSA6400	6"	400X
PSA780	7"	80X
PSA7120	7"	120X
PSA7220	7"	220X

Minimum order 50 discs (1 box). All sizes and grits can be combined for quantity pricing.

BACKUP PADS

CAT. NO.	SIZE	MOUNTING TYPE
PAD5	5"	3/8" Long, 5/16"-18 Male Stud
PAD6	6"	3/8" Long, 5/16"-18 Male Stud
PAD7	7"	5/8"-11 Thread Adapter (such as CRL Cat. No. 5704)



CAT. NO. PAD5



CAT. NO. PAD6



CAT. NO. PAD7



CRL Sanding Bands

- Available in 60X, 80X, 120X, and 220X Grits
- Fits Standard 1" and 2" Sanding Drums Shown Below



2" X 2" Bands

1" X 2" Bands

1" DIAMETER BY 2" LONG SANDING BANDS FOR 12SD SANDING DRUM

CAT. NO.	GRIT	BANDS PER BOX
1X260X	60X	10
1X280X	80X	10
1X2120X	120X	10
1X2220X	220X	10

Sizes and grits can be combined for quantity pricing. Minimum Order: 1 Box.

2" DIAMETER BY 2" LONG SANDING BANDS FOR 22SD SANDING DRUM

CAT. NO.	GRIT	BANDS PER BOX
2X260X	60X	10
2X280X	80X	10
2X2120X	120X	10
2X2220X	220X	10

Sizes and grits can be combined for quantity pricing. Minimum Order: 1 Box.

CRL Sanding Drums

- For Sanding Cut-Outs and Incurves, Speak Hole and Mail Slot Openings



CAT. NO. 12SD



CAT. NO. 22SD



Use these CRL Sanding Drums with our Sanding Bands in your portable electric drill to sand rounded edges, inside circles, notches, etc. Simply slip the Sanding Band over the rubber-cushioned drum and you are ready to go.

CAT. NO.	DIAMETER	LENGTH	SHANK
12SD	1"	2"	1/4"
22SD	2"	2"	1/4"

Sizes can be combined for quantity pricing.

CRL Cork Polishing Belts

- For High Polishing of Glass Edges
- Sizes for Portable or Upright Sanders



CRL Cork Polishing Belts are made of cork and pumice compound bonded to a fabric-backed belt. There are sizes to fit most upright or portable belt sanders. Cork Belts should be used wet, and you should also satin polish or semi-polish the glass with a 320X or 400X belt before using the Cork Belt.

CAT. NO.	SIZE
CRL38X21CORK	3/8" x 21"
CRL118X21CORK	1-1/8" x 21"
CRL3X18CORK	3" x 18"
CRL3X21CORK	3" x 21"
CRL3X24CORK	3" x 24"
CRL4X64CORK	4" x 64"
CRL4X82CORK	4" x 82"
CRL4X84CORK	4" x 84"
CRL4X106CORK	4" x 106"
CRL4X118CORK	4" x 118"
CRL4X132CORK	4" x 132"

Sizes and grits can be combined for quantity pricing. Minimum order is one belt, except for 3/8" x 21" size, where the minimum order is one box.

CRL Diamond Grinding Bits



CAT. NO. DRB14

Round Edge Bit for
3/16" to 1/4" Glass



CAT. NO. DSB14

Seamed Edge Bit for
1/4" Glass

These top quality Diamond Grinding Bits edge cut-outs quickly. Diamond coated edging troughs grind glass edges smoothly.

NOTE: Use CRL Diamond Tool Coolant Cat. No. DTC80GL to prevent heat build-up and prolong bit life.

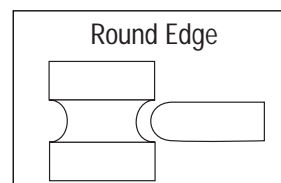

The Round Edge Bit produces a round edge on 3/16" (5 mm) and 1/4" (6 mm) glass.

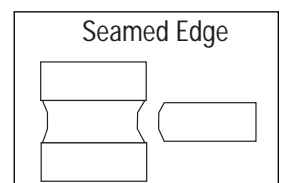

The Seamed Edge Bit produces an edge with flat arrises on 1/4" (6 mm) glass.



CRL Diamond Hand Pads

- Long Lasting Diamond Abrasive
- Works Great on Smooth or Uneven Surfaces
- Use Wet or Dry

CRL Diamond Hand Pads are plated diamond abrasive surfaces permanently glued to rigid foam support pads. Use wet or dry for fine finish work on glass, marble, ceramics, granite, and other composites. Their ideal hand size requires minimal effort and allows a more consistent finish. Diamond grade or grades required are based upon the finish and amount of material to be removed:

Use 60 grit only for high material removal situations.

Use a 400 grit pad if a high polish is required.

Pads measure 2-1/4" by 3-3/4" (57 by 95 mm).

GRADE RANGE FOR GLASS



CAT. NO.	COLOR	GRIT
DHP60	Green	60X
DHP120	Black	120X
DHP220	Red	220X
DHP400	Yellow	400X
DHPSET	All	Set of All Four

CRL 3M™ Flexible Diamond Hand Pads

- Available in Grits from 60X to 800X
- Use Wet or Dry

3M™ Flexible Diamond Hand Pads have a diamond surface bonded to a comfortable foam backing with finger holds. Slight flexibility allows pad to conform to the surface being worked. Used wet or dry, these pads provide very long life. Choice of grits based upon the finish and amount of material to be removed:

Use 60 grit only for high material removal situations.

Use a 800 grit pad if a high polish is required.

Pads measure 2-1/4" by 3-3/4" (57 by 95 mm).

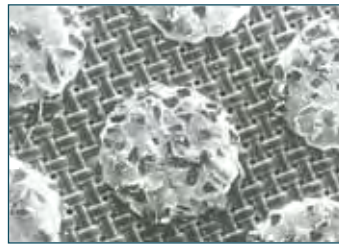

Highly Magnified Photo Shows Diamonds Bonded to Nickel Dot



CAT. NO.	COLOR	GRIT
Z2G6021	Green	60X
Z2B12018	Black	120X
Z2R22018	Red	220X
Z2Y40018	Yellow	400X
Z2W80018	White	800X
Z2SET	All	Set of All Five

CRL Sanding Sticks

CRL Sanding Sticks were developed for anyone who needs to finish detailed or hard-to-reach surfaces. Their unique design allows the user to rotate the abrasive belt 360° for its complete and economical use. The spring loaded tensioning device keeps the belt firmly in place and allows for quick

belt change. The leading edge is tapered for work in tiny openings. Two sizes are available to accommodate detailed or wider scale work. Abrasive belts for Sanding Sticks come 20 per package, all of one grit, in three popular grits: 80X, 120X, and 240X.



- Easy to Use - Ideal for Cut-Outs and Other Hard to Reach Areas

SANDING STICKS

CAT. NO.	TOOL SIZE	HOLDS BELT WIDTH
SS128H	1/2" x 8"	1/2"
SS146H	1/4" x 6"	1/4"

OK to mix for quantity pricing.

SANDING STICK ABRASIVE BELTS

CAT. NO.	BELT WIDTH	GRIT
SSA1280X	1/2"	80X
SSA12120X	1/2"	120X
SSA12240X	1/2"	240X
SSA1480X	1/4"	80X
SSA14120X	1/4"	120X
SSA14240X	1/4"	240X

Minimum order: 1 package (20 Belts).

CRL Hand Glass Seamer

- Seams Both Edges of Freshly Cut Glass Lites at Once

With the CRL Hand Glass Seamer you can seam both edges of freshly cut glass at once, saving yourself time. Built-in safety hand guards to prevent your hands from slipping. This light, hand-held tool smoothes glass in widths from 1/8" to 1/2" (3 to 12.7 mm). Replacement Stones are quick and easy to replace. Every glass shop should have one.



CAT. NO. HGS251

CAT. NO.	DESCRIPTION
HGS251	Hand Glass Seamer
HGSR478	Replacement Stone

CRL Crystolon Rubbing Bricks

- Use for Hand Grinding or Truing Wheels



Use CRL Crystolon Rubbing Bricks for hand grinding and smoothing on glass edges. They are also useful for truing up flat faces on smoothing wheels. Choice of three grits.

CAT. NO.	GRIT
CRS80	80X Rough
CRS120	120X Medium
CRS220	220X Smooth

CRL Retractable Blade Utility Knife

- Holds Blade in Full, One Half or One Quarter Extended Positions



CAT. NO. 99

This CRL Retractable Blade Utility Knife holds the extended blade in full cut, one half, or one quarter position. Comes with a heavy-duty blade stored inside of the two-piece handle. Our 1992C Utility Knife Blades (shown below) are an excellent blade for this knife.

CRL Heavy-Duty Fixed Blade Utility Knife

- Industrial Quality Die Cast Handle
- Comes with Five Blades



CAT. NO. 199

This CRL Heavy-Duty Fixed Blade Utility Knife is an easy to use basic knife that has a fixed blade. For the shop that uses and or loses a lot of knives, this inexpensive model is an ideal purchase. CRL 1992C Utility Knife Blades (shown below) are the perfect fit for this knife.

CRL Standard Retractable Utility Knife

- 3-Position Heavy-Duty Slider Actuation
- Overlapping Nose for Safety



CAT. NO. 97K

The CRL Standard Retractable Utility Knife has a safety overlap that keeps the blade from slipping between the handle halves, an important safety consideration. It uses our Cat. No. 1992C Utility Knife Blades.

CRL Stanley Swivel-Lock Utility Knife

- Ergonomic Design
- Quick Blade Change

new



CAT. NO. ST10799

The Stanley Swivel-Lock Fixed Blade Utility Knife swivels open so you can change the blade without using tools. The thumb dial locks the blade in place, and there is a magnet in the nose to hold the blade while the knife is open. It has a cast metal core with soft panels for a comfortable grip, and comes with three heavy-duty utility knife blades stored in the handle.

CRL QuickBlade Utility Knife

- Quick, Easy Blade Changing



CAT. NO. 77K

Blade changing is faster than ever with the CRL QuickBlade Utility Knife. Rugged metal body is ergonomically designed with two rubber grip pads for comfort and control. One hand thumb-turn movement operates the spring loaded, hinged release to open the split body of the knife. Storage area inside the handle holds five extra blades, and the closed top blade guard prevents injury from blade slippage. Uses CRL Cat. No. 1992C Heavy-Duty Utility Knife Blades.

CRL Utility Knife Blades

- Available in Easy to Use Dispensers
- Standard, Heavy-Duty and Hook End Blades

CRL Utility Knife Blades fit all standard, heavy-duty and retractable blade utility knives. The 1992C features an easy slide-out dispenser, and is our most popular utility blade.



CAT. NO.	BLADE TYPE	QTY./PKG.	PACKAGING TYPE
1991C	Standard	100	20 Each 5-Pack Blades
1991X10	Standard	10	10 Blade Dispenser
1992C	Heavy-Duty	100	100 Blade Dispenser
1992X10	Heavy-Duty	10	10 Blade Dispenser
1996C	Hook End	100	20 Each 5-Pack Blades
1996X10	Hook End	10	10 Blade Dispenser

10 packs can be combined for quantity pricing. 100 blade packages can be combined for quantity pricing.

CRL Utility Knife Sheath

- Designed for All Standard Utility Knives

Designed to fit standard utility knives, this fiber lined, saddle leather CRL Utility Knife Sheath features rivet reinforcing and an extra wide 2-3/4" (70 mm) belt slot.



CAT. NO. MN453R



CRL Razor Blade Knife

- Uses CRL 51S Razor Blades for Scraping and Cutting



CAT. NO. 117200

This CRL Razor Blade Knife Tool is a safe and easy way to handle single edge razor blades for cutting and scraping. Very commonly used when scraping walls, windows, paint, and labels. CRL 51S Single Edge Razor Blades are recommended for use with this tool.

CRL Olfa Heavy-Duty Utility Knife

- Adjustable Blade Length



CAT. NO. L2K

This Olfa Heavy-Duty Utility Knife features a high impact plastic handle and stainless steel blade housing. The positive locking thumbscrew allows the blade to be set to your desired length. Use LB10B or LS0L Replacement Blades (shown below) with this knife.

CRL Olfa Replacement Blades

- Blades to Fit L2K and XL2 Utility Knives



Heavy-Duty Breakaway Blades



Heavy-Duty Solid Blades

Super Sharp blades for use in the Olfa L2K or XL2 Knives.

CAT. NO.	DESCRIPTION
LB10B	Pack of 10 Breakaway Blades
LS0L	Pack of 10 Solid Blades

CRL Olfa Stainless Steel Compact Knife

- Fits In Shirt Pocket



SVR1 Compact Knife



AB10S Breakaway Blades

The Olfa SVR1 Compact Knife is great for cutting urethane, silicone, boxes and more. The stainless steel housing has a pocket clip that doubles as a device to snap away the used section of blade.

CAT. NO.	DESCRIPTION
SVR1	Compact Knife
AB10S	Pack of 10 Breakaway Blades

CRL Stanley Sport Utility Knife

new

- Two Knives in One
- Nylon Sheath Included



CAT. NO. ST10801

With this Stanley Sport Utility Knife you get two knives for the price of one. The knife has a stainless steel folding lock blade for general use. Simply turn the handle and you have a retractable blade utility knife. Three extra utility knife blades can be held in the handle. Changing the utility blades is as quick and easy as pushing a button. Each knife comes complete with a nylon sheath and one utility knife blade.

CRL Olfa Heavy-Duty Extended Length Knife

- Longer Handle for Cutting in Hard to Reach Places

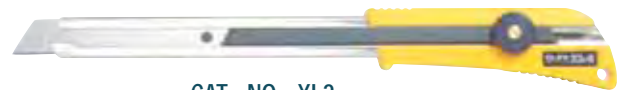

CAT. NO. XL2

The Olfa Heavy-Duty Extended Length Knife was designed with hard to reach places in mind. Reaching along the bottom of windshields will no longer be a problem with the XL2. It has a locking thumbscrew, stainless steel housing and rubber grip. Use LB10B or LS0L Replacement Blades (shown below) with this knife.

CRL Olfa Super Heavy-Duty Knife

- Large 1" Wide Breakaway Blade



HB5B Breakaway Blades



H1K Knife

This Olfa Super Heavy-Duty Knife was designed for the toughest of jobs with a .028 inch thick blade that will extend a full 4" (102 mm). A rubber grip handle on the back provides a non-slip surface for safety and comfort.

The H1K is the choice for heavy-duty cutting.

CAT. NO.	DESCRIPTION
H1K	Super Heavy-Duty Knife
HB5B	Pack of Five Breakaway Blades

CRL Stanley Pocketknife

- Rugged Chrome Plated Pocketknife
- Stainless Steel Blade with Safety Lock Feature



This rugged, polished and chrome plated Stanley Pocketknife with a cutlery stainless steel blade also has a safety lock feature. The ergonomically designed grip adds to the ease of use and performance. The blade is easily replaced. The knife comes individually carded.

CAT. NO.	DESCRIPTION
ST10049	Pocketknife
ST11041	Replacement Blade

CRL 18V DC Cordless Variable Speed Impact Driver/Drill Kit

new

- **Two Variable Speed Ranges:**
0 to 500 or 0 to 1,150 RPM
- **Two Impact Speeds: 6,400 and 18,000**
Strokes Per Minute
- **3/8" Keyless Chuck** • **Reversible**



The CRL 18 Volt Cordless Variable Speed Impact Driver/Drill is a lot of tool for a very conservative price. Put a drill bit or the included double-headed screwdriver bit into the keyless 3/8" chuck and pull the trigger for drilling/driving in two speed ranges: 0 to 500 rpm, and 0 to 1,150 rpm. Twist the collar and you have an impact drill with an impact frequency of 6,400 or 18,000 strokes per minute. Reverses with the flick of a conveniently located button. The tool has a molded grip and is well balanced for comfortable extended use.

Kit Contains the Following in a Handy Plastic Carrying Case:
One Driver/Drill with Keyless Chuck, One Battery Cartridge, One Battery Charger, One Phillips/Slotted Driver Bit, Six Hex Insert Screwdriver Bits, and Six High Speed Steel Drill Bits

CAT. NO.	DESCRIPTION
LD147	18 Volt Variable Speed Impact Drill Kit
LD147B	18 Volt Battery Cartridge for LD147
LD147C	Charger for 18 Volt Battery

CRL Makita 12V DC Cordless Driver/Drill Kit

- **Cordless, Reversible, and Powerful Drill**
has 12V DC Motor
- **Two Variable Speeds 0 to 400 or 0 to 1,200 RPM**
- **3/8" Keyless Chuck**

This CRL Makita Cordless Driver/Drill has a 12 volt power system that delivers a maximum torque value of 287 in./lbs.

Features Include the Following:
Removable 12 Volt Battery (with Charger); Two Reversible Variable Speed Ranges: 0 to 400 or 0 to 1200 RPM; Keyless Chuck Capacity: 1/16" to 3/8" (1.6 mm to 9.5 mm); Positive Lock Feature; 18 Torque Settings; Electric Brake for Pinpoint Seating of Screw Head; Slim Grip Handle for Superb Balance.

Kit Contains the Following in a Handy Plastic Carrying Case:
One Driver/Drill, Two Batteries, One Charger, One Positive Lock KeylessChuck, One Phillips/Slotted Bit, One Belt Clip, One Battery Cover



CAT. NO. 6217DWDEX

CRL Makita 9.6V DC Cordless Variable Speed Driver/Drill Kit

- **Two Variable Speeds:**
0 to 350 or 0 to 1,100 RPM
- **16-Stage Torque Clutch**
- **3/8" Keyless Chuck** • **Reversible**

This CRL Makita 9.6V DC Variable Speed Driver/Drill is one of the Makita 9.6V DC battery operated tools that share a common power source. It has a quick and easy adjusting sixteen stage torque clutch for a variety of fastening applications. Select from two speed ranges: low speed 0 to 350 rpm, or high speed 0 to 1,100 rpm. The reversing switch is conveniently located, an overload protector guards the motor from burnout, and the electric brake stops the chuck fast.

Kit Contains the Following in a Handy Plastic Carrying Case:
One Driver/Drill with Keyless Chuck, Two Batteries, One Battery Cover, One Battery Charger, One Phillips/Slotted Bit

CAT. NO.
6226DWE



CRL Makita 3/8" Cordless Angle Drill Kit

- Variable Speed 0 to 800 RPM
- Reversible
- Keyless Chuck

The CRL Makita 3/8" Angle Drill Kit is ideal for close quarters operation. It measures 4-9/16" (115 mm) from the tip of the chuck to the widest portion of the body. It is lightweight and weighs only 2.9 lbs (1.3 kg) for easy maneuverability, and has a rugged case for durability. The powerful 0 to 800 rpm motor will drill up to 200 3/8" (9 mm) holes in wood on a single charge. Reversible for drilling or driving screws. Part of the Makita family of 9.6 VDC tools that use a common battery and charger.

This Kit Contains the Following in a Handy Plastic Carrying Case:

- One Angle Drill,
- One Battery,
- One Charger,
- One Keyless Chuck



CAT. NO. DA390DW

CRL Makita 3/8" Angle Drill

- Variable Speed 0 to 1400 RPM
- Reversible
- Heavy-Duty 3/8" Chuck



CAT. NO. DA3000R

The high quality CRL Makita 3/8" Angle Drill has a compact design for working in limited space situations. Lightweight 3.5 lbs (1.6 kg) for easy one-handed operation. Variable speed trigger control from 0 to 1,400 rpm. Motor housing has a paddle switch and positive control. Heavy-duty 3/8" chuck; double insulated; 115V AC powered; AMPS at 115V: 2.8; Overall length: 10-3/4" (27.3 cm).

CRL Milwaukee® 1/4" Electric Drill

- Variable Speed 0 to 2500 RPM
- Reversible
- Heavy-Duty 1/4" Chuck

This high quality, heavy-duty CRL Milwaukee® Electric Drill has a 1/4" chuck capacity and variable speed trigger control from 0 to 2500 rpm. Reverses with the flick of a switch. High impact plastic handle is contoured for a comfortable grip. 115V AC powered.

Features Include the Following:

- Aluminum Gear Case and Diaphragm supplies greater support for shaft and bearings;
- Heavy-duty Industrial Chuck; powerful Milwaukee-Built Motor; Trigger Speed Control
- Reversing Switches; high-strength, impact-resistant Handles; Ball and Roller Bearings;
- Helical-cut, Heat-Treated Gears for heavy-duty industrial/construction applications; Two-Finger Trigger.



CAT. NO. 01021

CRL Fractional Size High Speed Drills



- Our Most Popular Drills
- Straight Shank

The CRL Jobbers Length Fractional Size High Speed Drills are available in the most popular fractional sizes for general use in metal or wood. When ordering drills in packs:

- Sizes up to 1/4" come in a shelf pack envelope of ten each.
- Sizes 5/16" through 1/2" come in a shelf pack envelope of five each.

For a full selection of individual drill sizes, check out the CRL Web Site at crlaurence.com.

CAT. NO.	SIZE	PKG/QTY
601332	3/32"	10
601764	7/64"	10
60118	1/8"	10
601964	9/64"	10
601532	5/32"	10
601316	3/16"	10
601732	7/32"	10
60114	1/4"	10
601516	5/16"	5
60138	3/8"	5
60112	1/2"	5

Sizes can be combined for quantity pricing.

CRL 29 Piece Fractional Gauge Drill Set

- From 1/16" to 1/2"

This CRL 29 Piece Drill Set comes in a hinged metal case. The set comes with thirteen 601 Series jobber's length High Speed Steel Drills in straight shank and sixteen 714 Series Drills with reduced sure grip knurled shanks for 1/4" chucks in the following sizes:



CAT. NO. S2914

601 Series:
1/16", 5/64", 3/32", 7/64", 1/8", 9/64", 5/32", 11/64", 3/16", 13/64", 7/32", 15/64", and 1/4"

714 Series:
17/64", 9/32", 19/64", 5/16", 21/64", 11/32", 23/64", 3/8", 25/64", 13/32", 27/64", 7/16", 29/64", 15/32", 31/64", and 1/2"

CRL 15 Piece Fractional Gauge Drill Set

- From 1/16" to 1/2"

This CRL 15 Piece Drill Set comes in a hinged metal case. The set comes with seven 601 Series jobber's length High Speed Steel Drills in straight shank and eight 714 Series Drills with reduced sure grip knurled shanks for 1/4" chucks in the following sizes:



CAT. NO. S1514

601 Series:
1/16", 3/32", 1/8", 5/32", 3/16", 7/32", and 1/4"

714 Series:
9/32", 5/16", 11/32", 3/8", 13/32", 7/16", 15/32", and 1/2"

CRL 13 Piece Fractional Gauge Drill Set

- From 1/16" to 1/4"

This CRL 13 Piece Drill Set comes in a hinged metal case. The set comes with thirteen 601 Series jobber's length High Speed Steel Drills in the following sizes:



CAT. NO. S13

601 Series:
1/16", 5/64", 3/32", 7/64", 1/8", 9/64", 5/32", 11/64", 3/16", 13/64", 7/32", 15/64", and 1/4"

CRL 10 Piece Fractional Gauge Drill Set

- From 1/16" to 1/4"

This CRL 10 Piece Drill Set comes in a resealable plastic pouch with a fractional and metric drill size gauge. The set contains ten 601 Series jobber's length High Speed Steel Drills in the following sizes:



CAT. NO. S110C

601 Series:
1/16", 5/64", 3/32", 7/64", 1/8", 9/64", 5/32", 3/16", 7/32", and 1/4"



CRL Weldon Countersinks

- Produce Smooth, Round Countersunk Holes Every Time
- Best Countersink Available for Aluminum
- Cut is 82°

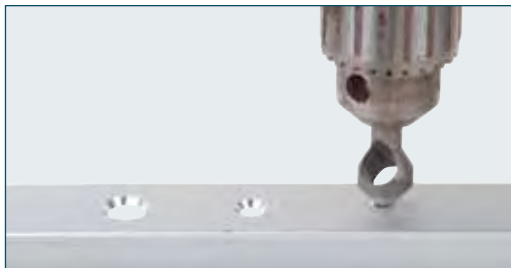

CRL Weldon Countersinks are specifically designed to cut round countersunk holes in aluminum. They cut faster than standard countersinks, and leave a finished hole every time. Smooth drilling action from single cutting edge prevents chatter and fluted edges. The 1/4" shank diameter fits any 1/4" or 3/8" drill chuck. Four popular sizes are available in a cost-saving set.



CAT. NO.	DIAMETER	USES
CS6S	19/64"	For No. 6 Screws
CS8S	11/32"	For No. 8 Screws
CS10S	25/64"	For No. 10 Screws
CS18	9/16"	For No. 12 and 14 Screws
CS26A	13/16"	For Large Holes



COUNTERSINK SET

CAT. NO.	SET INCLUDES
CS618S	1 Each CS6S, CS8S, CS10S, and CS18

CRL Unibit Step Drills

- Drill Up to 13 Diameters with Just One Drill
- Perfectly Round Holes in Thin Materials

The CRL Unibit Step Drill uses a unique, single flute design to drill perfectly round holes in thin materials. Cutting steps of progressively larger diameters make it possible to drill up to 13 different hole sizes with a single bit. Also, the hole is automatically deburred by the cutting edge of the next size up.

Hole starting is easy because it won't skid across the surface, even without center punching. Designed for use with steel, copper, brass, aluminum, and other thin metals, it can also be used on plastics without chipping or clogging.

CAT. NO.	DESCRIPTION
UB1	1/8" to 1/2"
UB2	3/16" to 1/2"
UB3	1/4" to 3/4"
UB123	Set of All 3



CRL Weldon 90° Deburring Tool

- Designed to Debur Holes
- Cut is 90°

CRL's Weldon 90° Deburring Tool was specifically designed to quickly and efficiently provide a clean, finished look to all your larger drilled holes. This Deburring Tool is economical, easy to use, will provide a smooth shear action similar to that of an end mill, and assures an excellent chatter-free finish.



CAT. NO. DB18

CRL Noxon® Centerpunch

- No Hammer Needed
- Made of Hardened Steel
- Ringed Ends for Sure Grip



With the CRL Noxon® Centerpunch it is a snap to mark the spot in a great variety of materials. Simply locate the spot to be punched, place tip and press, lift plunger and release. The heavy spring action produces quick results. Choose either the two-end Centerpunch and Nail Set, or the Centerpunch only. Made in U.S.A.

CAT. NO.	DESCRIPTION
NOX1	Centerpunch Only
NOX2	Centerpunch/Nail Set

CRL Carbide Point Scribe and Marker

- Marks Steel, Aluminum, Stainless Steel, Copper, Glass, and Ceramics
- Tungsten Carbide Point



CAT. NO. G88

The CRL Carbide Point Scribe and Marker, with its tungsten carbide tip, will mark steel, aluminum, stainless steel, copper, ceramics, and glass. It has a screw chuck for reversing the point when not in use, or when changing points. The tool measures 6" (152 mm) overall, and comes with a handy pocket clip. For replacement point, order Cat. No. G88P.

CRL Magnetic Screwdriver with Four Bits

- Bits Included in Handle Storage Compartment

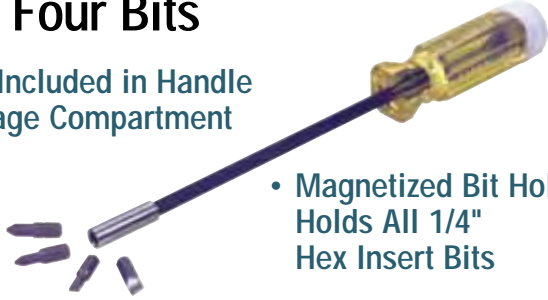

- Magnetized Bit Holder Holds All 1/4" Hex Insert Bits

Mechanics, builders, glaziers, assemblers, and electricians find the CRL Magnetic Screwdriver almost indispensable. It drives any 1/4" (6 mm) hex head screws or hex nuts. The magnetic force holds insert bits securely, yet bits are easily changed. Comfortable fluted plastic handle contains four insert bits: #1 and #2 Phillips; #4 and #8 Slotted. Available in three lengths.

CAT. NO.	OVERALL LENGTH
3192	3-3/8" (85 mm)
3195	8" (203 mm)
3198	11-1/2" (292 mm)

CRL 4-in-1 Screwdriver

- Complete with Phillips and Slotted Bits



CAT. NO. 4N1

This CRL 4-in-1 Screwdriver has two replaceable #1 and #2 Slotted and Phillips bits which fit into the special handle. Bits can be changed in seconds. Just pull out, change the bit, then snap it back in. Alloy tool steel bits are ground and polished, and heat treated for maximum strength.

CRL Ratcheting Extension Screwdriver with Six Bits

- Magnetic Tip Shaft Extends from 9-1/4" to 15" and Locks in Place
- Handle Ratchets Left, Ratchets Right, or Works in the Fixed Position



CAT. NO. H109

This CRL Ratcheting Extension Screwdriver has a magnetic tipped shaft that extends from 9-1/4" to 15" (235 to 381 mm) overall length. The shaft extends in 1/16" (1.6 mm) increments, and locks into place automatically. You retract it by pushing up on the release collar that also holds the six insert bits: two each Phillips, Slotted, and Torx.

CRL Vaco Bull Drivers

- Chrome Plated Shafts
- Super Hard Tips



CAT. NO. BD144
Slotted Head



CAT. NO. BD122
Phillips Head

CRL Vaco Bull Screwdrivers have an exclusive handle that is larger and delivers more driving power. Designed for continuous, comfortable use, it allows you to perform the toughest driving jobs without becoming fatigued. Each of our screwdrivers feature a professionally made tip that is manufactured with a super hard point. Overall length: 8-1/2" (216 mm).

CRL 30 Piece Master Screwdriving Set

- Phillips, Slotted, Torx®, Allen, Square, and Clutch Bits Included
- 30 Pieces Including the Handy Carrying Case

This CRL 30 Piece Master Screwdriving Set offers a complete range of styles and sizes of bits. This set contains the following in a handy carrying case:

- 7" Multi-Bit Magnetic Screwdriver
- Magnetic Bit Holder that Fits Into All Variable Speed Drills
- 1/4" Square Drive Insert Bit Adapter
- 1/4" Hex Insert Bits:
 - Phillips numbers 1, 2, and 3
 - Slotted numbers 3-4, 6-8, 8-10, and 10-12
 - Torx® numbers TX10, TX15, TX20, TX25, TX27, TX30, and TX40
 - Square Recess numbers 1, 2, and 3
 - Clutch 5/32" and 3/16"
 - Allen 5/64", 3/32", 7/64", 1/8", 9/64", 5/32", and 3/16"



CAT. NO. 15568



CRL Hex End Mirror Bracket Wrench

- 5/64" and 3/32" Hex Ends for Virtually All Mirrors

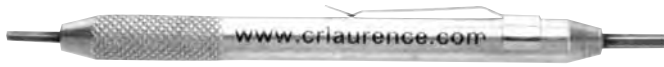

CAT. NO. MB2

One of the tools every auto glass technician needs is the CRL Hex End Mirror Bracket Wrench. It is used to remove or replace windshield mounted rear view mirrors during windshield replacements. The pocket clip keeps this tool handy.

CRL Torx® End Mirror Bracket Wrench

- Fits in Your Pocket
- TX15 and TX20 Ends



CAT. NO. MB2TX

This new style CRL Torx® End Mirror Bracket Wrench has a No. TX15 Torx® bit on one end, and a No. TX20 Torx® bit on the other. For new model GM and Chrysler cars. The pocket clip keeps the tool handy.

CRL 6-in-1 Mirror Bracket Tool

- Torx®, Allen, Slotted, and Phillips Bits with Combined Driver Handle/Carrying Case
- Perfect "Must Have" Tool for the Mobile Operator



CAT. NO. MB6N1

We have combined the most popular mirror bracket removal and replacement bits along with a driver handle/carrying case in our CRL Six-in-One Mirror Bracket Tool. Together they make up the most versatile mirror bracket tool ever. Housed in the sturdy case are one each of the following:

- Cat. No.'s 440TX15 and 440TX20 TX15 and TX20 Torx® Bits;
- Cat. No. 1851 and 1853 3/32" and 5/64" Allen Bits;
- Cat. No. 4453 #8 Slotted Insert Bit;
- Cat. No. 4402 #2 Phillips Bit;
- Cat. No. M490 Insert Bit Holder

CRL Stanley Offset Ratcheting Screwdrivers

- Great for Tight Work Areas



CAT. NO. ST68402 Combination

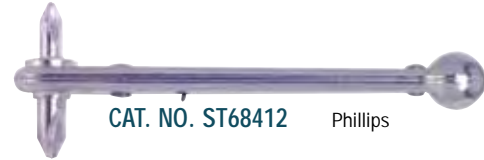

CAT. NO. ST68412 Phillips

The CRL Stanley Offset Ratcheting Screwdrivers come in two types, Phillips and a combination Phillips and Slotted. They need only a minimum of clearance to work. A small sliding latch changes the ratcheting directions. Hardened tips will give long service.

CRL Offset Phillips Screwdriver

- #1 and #2 Phillips Tips



CAT. NO. P120

Set your screws easily in tight places with this CRL Offset Phillips Screwdriver. There is a different size point on each end, and the crank type motion puts power in each turn.

CRL 6-in-1 Pocket Driver with Phillips and Slotted Bits

- A Convenient 6-in-1 Screwdriver in a Compact Carrying Case



CAT. NO. PD6N1



The CRL Pocket Drive Tool is a convenient and compact six-in-one screwdriver. It is in a small plastic case, 1-3/4" by 2-3/4" (44 mm by 70 mm), with a clip attached, allowing you to carry it on a belt, strap, or even on a car visor. Inside the case are six hex insert bits (#1, 2, 3 Phillips and #4, 6, 8 Slotted) and a 2-3/8" (60.3 mm) long magnetic shaft. Simply open the case, remove the shaft and the desired insert bit. Then, close the case and insert the shaft into the hole at the end of the case. With the case acting as a handle, you now have a six-in-one screwdriver.

CRL 1/4" Hex Phillips Insert Bits



CAT. NO. 4401



CAT. NO. 44022



CAT. NO. 4402



CAT. NO. SD333



CAT. NO. 4461



CAT. NO. 4462

CRL Phillips Insert Bits come in six sizes and four styles: regular, undercut, long, and heavy-duty. We have bits that are available for use with Phillips screws that have point sizes for #1, #2, and #3.

CAT. NO.	TYPE	POINT SIZE	SCREW SIZES	LENGTH
4401	Standard	1	2-3-4	1"
4402	Standard	2	5-6-7-8-10	1"
44022	Long	2	5-6-7-8-10	2"
4461	Undercut	1	2-3-4	1"
4462	Undercut	2	5-6-7-8-10	1"
SD333	Heavy-Duty	3	12-14	1-1/4"

All Hex Insert Bits can be combined for quantity pricing.

CRL Phillips Screwgun Bits



CAT. NO. 491



CAT. NO. 491A



CAT. NO. 491B

CRL Phillips Screwgun Bits are available in #1, #2, and #3 point sizes. 1-15/16" (27.8 mm), 2-3/4" (69.9 mm), and 3-1/2" (88.9 mm) lengths fit all standard electric screwguns.

CAT. NO.	POINT SIZE	BODY DIAMETER	SCREW SIZES	LENGTH
491	1	3/16"	2-4	1-15/16"
492	2	1/4"	6-8-10	1-15/16"
493	3	5/16"	12-14	1-15/16"
491A	1	3/16"	2-4	2-3/4"
492A	2	1/4"	6-8-10	2-3/4"
493A	3	5/16"	12-14	2-3/4"
491B	1	3/16"	2-4	3-1/2"
492B	2	1/4"	6-8-10	3-1/2"
493B	3	5/16"	12-14	3-1/2"

All Hex Insert Bits can be combined for quantity pricing.

CRL Magnetic Hex Head Screw Holders

• For Hex and Hex Washer Head Screws



CAT. NO. MDB08

CRL Magnetic Hex Head Screw Holders fit all standard electric screwguns. Holds hex and hex washer head screws while driving.

CAT. NO.	HEX OPENING	SOCKET BODY DIAMETER	SHANK SIZES
MDB08	1/4"	7/16"	1/4"
MDB10	5/16"	1/2"	1/4"
MDB12	3/8"	9/16"	1/4"
MDB14	7/16"	5/8"	1/4"

Sizes can be combined for quantity pricing.

CRL 1/4" Hex Torx® Insert Bits



CAT. NO. 440TX07

CRL Standard Torx® Insert Bits come in sizes to fit the most common Torx® screws.

CAT. NO.	DRIVER SIZE	A (REF.)	LENGTH
440TX07	T7	.077	1"
440TX10	T10	.107	1"
440TX15	T15	.128	1"
440TX20	T20	.151	1"
440TX25	T25	.173	1"

All Hex Insert Bits can be combined for quantity pricing.

CRL 1/4" Hex Slotted Insert Bits



CAT. NO. 4451



CAT. NO. 4452



CAT. NO. 4453



CAT. NO. 4454



CAT. NO. 4455



CAT. NO. 4456

CRL Hex Slotted Insert Bits come in six sizes to fit slotted screws from #4 flat to #16 round head.

CAT. NO.	TIP WIDTH AND THICKNESS	SCREW SIZES	LENGTH
4451	3/16" x .034	4 Flat - 5 Round	1"
4452	7/32" x .040	6 Flat - 8 Round	1"
4453	1/4" x .042	8 Flat - 10 Round	1"
4454	9/32" x .046	10 Flat - 12 Round	1"
4455	5/16" x .050	12 Flat - 14 Round	1-1/2"
4456	23/64" x .055	14 Flat - 16 Round	1-1/2"

All Hex Insert Bits can be combined for quantity pricing.

CRL 1/4" Hex Square Insert Bits



CAT. NO. 9500

CRL Square Insert Bits can be used for screw sizes 3 to 14.

CAT. NO.	NOMINAL SQUARE SIZE	SCREW SIZES	LENGTH
9500	1/16"	3-4	1"
9501	3/32"	5-6-7	1"
9502	1/8"	8-9-10	1"
9503	9/64"	12-14	1"

All Hex Insert Bits can be combined for quantity pricing.



LOG ON TO crlaurence.com FOR BUSINESS-TO-BUSINESS SERVICES

A374 | PHONE (800) 421-6144 | FAX (800) 262-3299 TOLL FREE FROM ANYWHERE IN THE U.S.A. OR CANADA

CRL Offset Hex Bit Driver

- Holds All 1/4" Hex Insert Bits
- Low Profile Angled Head
- Removable from Handle for Use in Power Driver



CAT. NO. M14895

The CRL Offset Hex Bit Driver lets you fasten or remove screws located in channels, under edges, or in areas where any regular screwdriver cannot fit. It has a 360° adjustable thumb flange with slip-fit action that quickly rotates to any position, allowing you to apply maximum force and giving you complete control. The low profile, angled head has hardened steel gears that are lubricated and sealed for a lifetime of service. The standard 1/4" (6.4 mm) hex socket securely holds all types of 1/4" (6.4 mm) hex insert bits including the #1 and #2 Phillips, and 3/16" and 1/4" Slotted bits that come with it.

CRL Screwgun Insert Bit Holders

- Available in Magnetic and Non-Magnetic

CRL Screwgun Insert Bit Holders convert your screwgun to hold 1/4" (6.4 mm) hex insert bits. Magnetic and non-magnetic type bit holders will hold all 1/4" hex insert bits.



CAT. NO. M490 Magnetic



CAT. NO. 490 Non-Magnetic

CRL Makita Finder/Driver

- Start Screws the Easy Way
- Screw Holder Holds Screw in Correct Starting Position without Wobbling or Disengaging from the Bit
- Outer Sleeve Slides Over the Screw and Keeps Bits in the Screw Slot



CAT. NO. 784810A Regular



CAT. NO. 784811A Stubby

The CRL Makita Finder/Driver is really four tools in one and a great accessory for anyone using an electric screwdriver. An extra strong magnet in the end secures all types of hex insert bits. The outer sleeve slides over the screw to keep it from wobbling or disengaging from the bit, even when driving in a horizontal position. Both the Regular and "Stubby" Finder/Driver accept #10 and smaller screws. Each comes with one #2 Phillips bit and one #6-8 Slotted bit.

CRL Bit Caddy

- Center Slot Holds Magnetic Adapter
- Holds Up to 37 Bits

The CRL Bit Caddy will secure as many as 37 bits, and has a center slot to store a magnetic adapter such as our Cat. No. M490. This soft, red plastic case is both practical and convenient. Compact size will fit in any tool box.

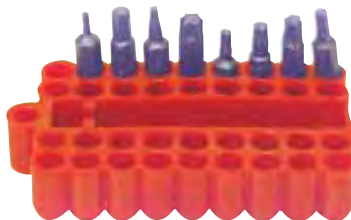

CAT. NO. APH037
Bits Not Included

CRL Scratch Awl

- One Piece Shank Handle
- Blade Thru-Handle



CAT. NO. ST69122

The CRL Stanley Scratch Awl blade, shank, and head are forged from one piece of the finest steel. There is one rivet through the ferrule, handle, and shank. The handle has flat sides to prevent rolling. This is a strong tool for tough use.

CRL Vaco 7 Piece U.S.E. Hex Nut Driver Set

- Seven Hex Nut Drivers in Sizes From 3/16" to 1/2"



CAT. NO. K7

The CRL Seven Piece Hex Nut Driver Set is an ideal kit for the work bench or tool box.

Set contains the following size drivers:
3/16", 1/4", 5/16", 11/32", 3/8", 7/16", and 1/2"

CRL Vaco 10 Piece Metric Hex Nut Drivers

- Ten Metric Hex Nut Drivers
- Sizes 4 mm to 11 mm



CAT. NO. 70200

This CRL Ten Piece Metric Hex Nut Driver Set is an ideal kit for the work bench or tool box. The metal stand will help you keep these drivers organized for easy selection.

Set contains the following size drivers:
4 mm, 4.5 mm, 5 mm, 5.5 mm, 6 mm, 7 mm,
8 mm, 9 mm, 10 mm, and 11 mm

CRL Ergo-Fold™ Hex and Torx® Key Sets

- Cushion-Grip Insert
- Hex, Torx®, and Ball-End Models

CRL Ergo-Fold Key Sets feature a composite grip handle shaped for superior ergonomics. A soft cushion-grip insert provides comfort and slip resistance. A hard shell provides maximum strength. As strong as steel, they are guaranteed forever. Ergo-Fold Keys provide extra reach for safer clearance from your work. All Fold-up Sets can be used at a right angle to generate maximum torque. Additionally, they can be used like a screwdriver, with the key folded out to a firm stop.

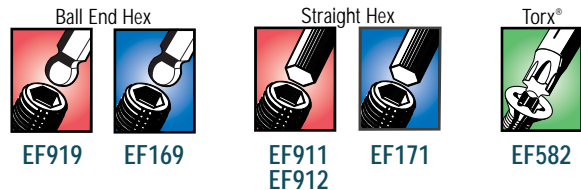
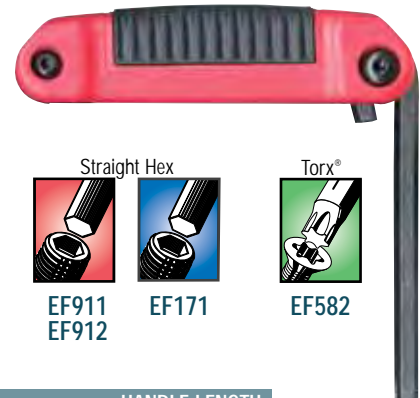

CAT. NO.	TYPE	KEYS	KEY SIZES	HANDLE LENGTH
EF919	Ball End Inch	9	5/64", 3/32", 7/64", 1/8", 9/64", 5/32", 3/16", 7/32", 1/4"	4-1/2"
EF169	Ball End Metric	6	2.0 mm, 2.5 mm, 3.0 mm, 4.0 mm, 5.0 mm, 6.0 mm	3-3/4"
EF912	Hex Inch	9	0.50", 1/16", 5/64", 3/32", 7/64", 1/8", 9/64", 5/32", 3/16"	3-3/4"
EF911	Hex Inch	9	5/64", 3/32", 7/64", 1/8", 9/64", 5/32", 3/16", 7/32", 1/4"	4-1/2"
EF171	Hex Metric	7	1.5 mm, 2.0 mm, 2.5 mm, 3.0 mm, 4.0 mm, 5.0 mm, 6.0 mm	3-3/4"
EF582	Torx®	8	T6, T7, T8, T9, T10, T15, T20, T25	3-3/4"

CRL 7-in-1 Fold Up Torx® Key Set

- Seven Different Torx® Bits Ranging from T10 to T40



CAT. NO. 22571

This handy CRL 7-In-1 Fold Up Torx® Key Set contains seven of the most used Torx® key sizes all in one handle. Fold-out keys are top quality chrome nickel alloy steel, precision machined and hardened for precise fit and long life. Torx® keys fit Torx® type recessed screws. The seven sizes of Torx® keys on this tool are: T10, T15, T20, T25, T27, T30, and T40.

CRL T-Handle Allen and Hex Key Set

- Easy to Grip Handles
- Sizes From 3/32" to 3/8"
- Includes a Convenient Stand



CAT. NO. 1600369

The long reach design with loop handle of the CRL T-Handle Allen and Hex Key Set gives greater torque and ease of use. Made of top quality chrome nickel alloy steel and drawn for closest tolerance to ensure precise fit, each key is hardened and tempered by a special tempering process for maximum strength.



CRL 21 Piece Socket Set

- Reversible Ratchet 1/4" Drive
- 6-Point Sockets from 3/16" to 1/2"



CAT. NO. ST85388

This CRL Stanley 21 Piece 1/4" Drive Socket Set includes the following items in a handy molded carrying case:

- Reversible Ratchet 1/4" Drive;
- Spinner Handle 1/4" Drive;
- 3" Extension 1/4" Drive;
- Extension 1/4" Drive;
- 1/4" Drive Universal Joint;
- Nine 6-Point 1/4" Drive Sockets, sizes:
3/16", 7/32", 1/4", 9/32", 5/16", 11/32", 3/8", 7/16", and 1/2";
- Seven 6-Point 1/4" Drive Deep Sockets, sizes:
1/4", 9/32", 5/16", 11/32", 3/8", 7/16", and 1/2"

CRL 27 Piece All Purpose Driving Set

- Phillips, Slotted, and Allen Bits
- Hex Sockets



CAT. NO. 15561

This CRL 27 Piece Screw and Nut Driver Set offers a complete range of styles and sizes of bits. This popular set provides the tools for most every fastening need. Handy and compact, it is perfect for your car, camper, workshop-almost everywhere. Adapters included also allow use in variable-speed drills. This kit contains the following in a handy molded carrying case:

- 7" (178 mm) Multi-bit Magnetic Screwdriver;
- 90° Offset Bit Adapter;
- Socket Adapter;
- Magnetic Bit Holder (fits All Variable Speed Drills);
- 1/4" Drive Sockets, sizes:
3/16", 1/4", 9/32", 5/16", 11/32", 3/8", 7/16", and 1/2"
- 1/4" Hex Phillip Insert Bits, point sizes: 1, 2, and 3
- 1/4" Hex Slotted Insert Bits, point sizes: 3-4, 6-8, 8-10, 10-12
- 1/4" Hex Allen Insert Bits, point sizes: 5/64", 3/32", 7/64",
1/8", 9/64", 5/32", and 3/16"

CRL 25 Piece Professional Wrench Set

- 25 Piece Fractional and Metric Combination Wrench Set
- Tempered, Drop Forged Alloy Steel
- Triple Chrome Plating

CAT. NO.
326473BNA



This CRL 25 Piece Professional Wrench Set has fully polished wrenches for easier cleaning, and triple chrome plating for years of use. Both fractional and metric wrenches are included in the set. This set includes the following sizes:

- Thirteen Fractional: 1/4", 5/16", 11/32", 3/8", 7/16", 1/2", 9/16", 5/8", 11/16", 3/4", 13/16", 7/8", and 1"
- Twelve Metric: 6 mm, 7 mm, 8 mm, 9 mm, 10 mm, 11 mm, 12 mm, 13 mm, 14 mm, 15 mm, 17 mm, and 19 mm

CRL 22 Piece Squeeze Wrench Set

- Gets Into Tight Places
- Made in the U.S.A.



CAT. NO. SQW5700

Our CRL 22 Piece Squeeze Wrench Set lets you get into places where a typical socket wrench won't fit. Squeeze the handle and the ratchet head turns without moving the wrench. Interchangeable bits let you change from a ratchet wrench to an Allen wrench to a screwdriver quickly and easily. All parts are heat-treated to the highest commercial standards, and packed in a sturdy carrying case. This set includes the following:

- Twelve Sockets: Six Fractional: 1/4", 5/16", 3/8", 7/16", 1/2", and 9/16"; Six Metric: 9 mm, 10 mm, 11 mm, 12 mm, 13 mm, and 14 mm;
- Six Allen Bits: 1/8", 5/32", 3/16", 7/32", 1/4", and 5/16";
- Two Phillips and Two Slotted Screwdriver Bits

CRL Adjustable Crescent Wrenches

- Drop-Forged and Heat Treated
- Five Sizes Available



These CRL Chrome Finished Adjustable Crescent Wrenches are drop-forged and heat treated for toughness and durability.

CAT. NO.	SIZE	CAPACITY
AC14	4"	1/2"
AC16	6"	3/4"
AC18	8"	15/16"
AC110	10"	1-1/8"
AC112	12"	1-5/16"

CRL Stanley MAXGRIP™ Locking Adjustable Wrench

- Combined Locking Plier and Adjustable Wrench
- Exceeds ASME Standards



CAT. NO. ST85610

The CRL Stanley MAXGRIP™ Locking Adjustable Wrench has a patented design that combines the functions of a locking plier and an adjustable wrench. The 10" (254 mm) wrench is forged and chrome plated. It exceeds ASME standards.

CRL Five Piece Ratcheting Wrench Set

- 10 Ratcheting Fractional Sizes



CAT. NO. 440T5A

The Ratcheting Wrenches in this CRL Five Piece Wrench Set accommodate 10 sizes of nuts or bolts, and function quicker than non-ratcheting wrenches. The set is packaged in a vinyl carrying pouch, and contains the following fractional sizes:

1/4" x 5/16", 3/8" x 7/16", 1/2" x 9/16", 5/8" x 3/4", 11/16" x 7/8"

CRL 13 Piece Fractional Wrench Set

- Fractional Sizes from 1/4" to 1"



CAT. NO. 03127

This CRL 13 Piece Fractional Wrench Set is made of rugged drop-forged alloy steel with a chrome-plated finish. Each piece is constructed with an efficient 12-point box end and an offset open end. Set contains the following fractional sizes:

1/4", 5/16", 11/32", 3/8", 7/16", 1/2", 9/16", 5/8", 11/16", 3/4", 13/16", 7/8", and 1"



CRL Plastic Trim Snips

- Use with Plastic or Vinyl Trims, Weatherstripping, and Auto Side Moldings
- Replaceable, Razor Sharp Stainless Steel Blades



CAT. NO. PTS89

CRL Plastic Trim Snips are a real time saver when working with plastic and vinyl trims or weatherstrips. The razor sharp blade makes quick cuts to leave precise edges and can be replaced if needed. The compound action handle is coated for a comfortable grip, and provides plenty of leverage to cut smoothly through rigid vinyl trim or auto side moldings. This knife comes with one each additional blade already packed inside the handle. For replacement blades order Cat. No. PTS89B.

CRL Pro-Snip Offset Snips

- Forged Steel Blades Keeps Hand Safely Above the Work

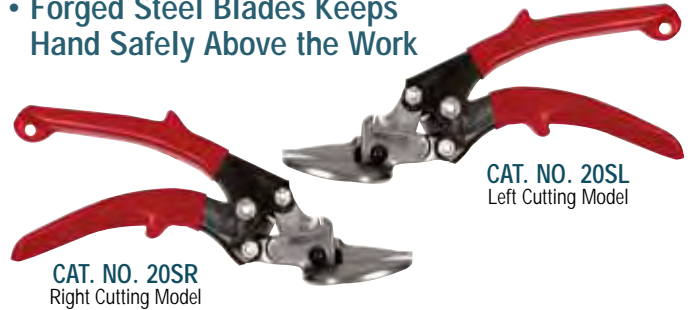

CAT. NO. 20SR
Right Cutting Model

CAT. NO. 20SL
Left Cutting Model

CRL Pro-Snip Offset Snips can handle virtually every cutting job in sheet metal, linoleum, carpet, screen wire and other material. The forged steel blades cut in three directions, so if you buy both right and left hand models, you'll be able to make almost any straight, sharp angle or circular cut. The curved handle keeps your hand safely above cut edges.

CRL Diagonal Cutting Pliers

- Available in 6", 7", and 8" Sizes



CRL Diagonal Cutting Pliers are designed to cut heavy wire easily. This tool features a comfortable grip handle, electronically hardened long life edges with polished heads.

CAT. NO.	TYPE	LENGTH
5428C	Heavy-Duty	8" (203 mm)
5427C	Standard	7" (177 mm)
9406	Short Nose	6" (152 mm)

CRL 7" End Cutting Nippers

- Cuts Wire Flush to Surface



CAT. NO. 727C

The CRL 7" End Cutting Nipper is specially designed to cut wire flush with the surface. Hardened jaws make this a top quality tool. Overall length is 7" (177 mm).

CRL 6" Needle Nose Pliers

- Ideal for Tight Places

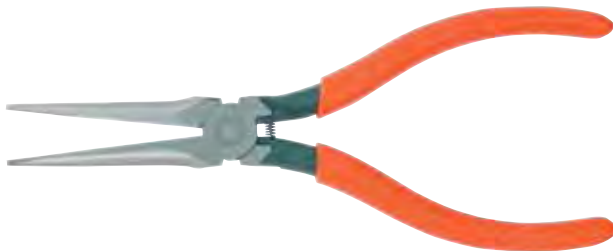

CAT. NO. 7776SC

CRL 6" Long Needle Nose Pliers have a thin nose that gives excellent gripping power in tight or narrow places. Drop-forged from fine alloy steel. Overall length is 6" (152 mm).

CRL Multiple Rib Joint Pliers

- Multi-Position Jaws for Big Gripping Jobs



CRL Multiple Rib Joint Pliers have multi-position jaws that open wide for those big gripping jobs. Choose from three available sizes.

CAT. NO.	SIZE	POSITIONS
R27C	7" (177 mm)	4
R210C	10" (254 mm)	5
R212C	12" (304 mm)	6

CRL Vise Grip Flat Jaw Sheet Metal Working Pliers

- Sheet Metal Clamping Tool with Tremendous Grip



CAT. NO. 8R

Eliminate tiresome hand gripping with CRL Vise Grip 8" Flat Jaw Sheet Metal Working Pliers. It locks with a tremendous grip, so metal can't slip. You get a smoother, more accurate bending and seaming job. Adjust it to a non-locking plier by tightening the end screw. Features an easy release. The jaws are 3-1/8" (108 mm) long. The throat adjustment is 1-3/4" (44 mm).

CRL Vise Grip Straight Jaw Pliers

- Available in 7" and 10" Lengths
- Easy Release



These CRL Vise Grip Straight Jaw Pliers can exert more than a ton of pressure between its jaws, which are adjustable to ratchet-like action. Easy release feature.

CAT. NO.	LENGTH	JAW WIDTH	THROAT ADJUSTMENT
7R	7" (17 cm)	7/16" (11.1 mm)	1-1/8" (28.6 mm)
10R	10" (25.4 cm)	5/8" (15.9 mm)	1-1/2" (38.1 mm)

CRL Vise Grip Long Nose Locking Pliers

- Jaws Have Wire Cutter
- A Very Versatile Tool

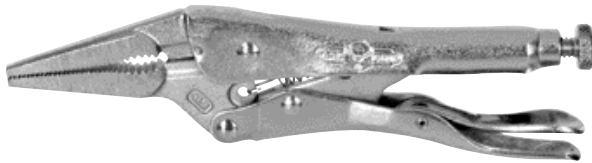

CAT. NO. 6LN

CRL Vise Grip 6" Long Nose Locking Pliers are engineered with traditional Vise Grip quality. They can do more jobs faster and easier than any other long nose pliers. The jaws are 1-3/4" (44 mm) long, and taper from 5/16" to 1/8" (7 mm to 3 mm) at the tip. The throat adjustment is 2-1/4" (57 mm). A wire cutter inserted in the jaws cuts heavy gauge wire.

CRL Vise Grip "C" Clamps

- Available in Two Sizes
- Easy Release

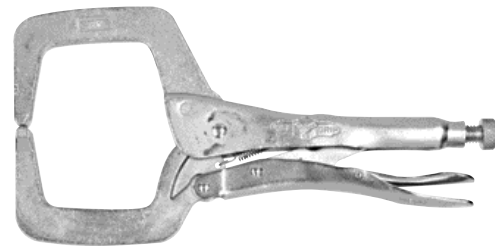

Just a turn of the end screw lets you properly adjust the jaws on the CRL Vise Grip "C" Clamp. To lock, just squeeze the handles. You can then apply the clamp with one hand and work with the other. A small jaw area at the contact points is ideal for close quarters. Made of special alloy steel, hardened and tempered.

CAT. NO.	LENGTH	JAW WIDTH
6R	6" (152 mm)	2" (51 mm)
11R	11" (279 mm)	3-3/4" (95 mm)

CRL Vise Grip Curved Jaw Pliers

- Easy Release Handle
- Made of Special Heat Treated Alloy Steel
- Available with or without Wire Cutter



Without Wire Cutter

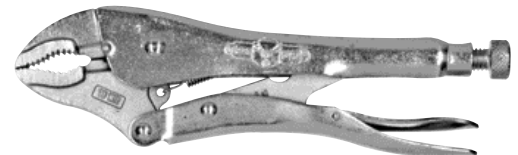

With Wire Cutter

CRL Vise Grip Curved Jaw Pliers are made of special alloy steel and heat treated for toughness. The curved jaw gives tooth contact on four points of nuts, and increases tooth contact on round work. Thin tapered nose permits work in close quarters.

CAT. NO.	WIRE CUTTER	LENGTH	JAW WIDTH	THROAT ADJUSTMENT
7CR	No	7" (177.8 mm)	7/16" (11.1 mm)	1-1/8" (28.6 mm)
10CR	No	10" (254 mm)	5/8" (15.9 mm)	1-1/2" (38.1 mm)
7WR	Yes	7" (177.8 mm)	7/16" (11.1 mm)	1-1/8" (28.6 mm)
10WR	Yes	10" (254 mm)	5/8" (15.9 mm)	1-1/2" (38.1 mm)



CRL Deluxe Spring Clamps

- Vinyl Coated Tips and Grip
- Bright Finish Resists Corrosion
- Available in Three Sizes



CRL Deluxe Spring Clamps have a modern design that minimizes the spread between handle ends, and makes the "Grip" more comfortable for the user. At full opening, the point of pressure remains at the jaw tips. Heavily plated steel clamps have a smooth, bright finish to resist corrosion.

CAT. NO.	MAX. JAW OPENING	SIZE
JC3201HT	1" (25.4 mm)	4" (102 mm)
JC3202HT	2" (50.8 mm)	6" (152 mm)
JC3203HT	3" (76.2 mm)	9" (228 mm)

CRL Quick Change Quick-Grip Bar Clamp/Spreader

- Takes Only One Hand to Operate
- High-Tech Resin Construction with a Quick Change Jaw



From the makers of Vise-Grip comes the new CRL Quick-Grip Bar Clamp/Spreader, the only bar clamp that takes only one hand to operate. It converts into a spreader quick and easy, with no tools required. The Quick Change Multi-Position Jaw can be positioned anywhere on the bar, making even the most challenging clamping or spreading task a snap. The unique pistol grip handle lets you hold the clamp and adjust jaw pressure instantly with only one hand. One finger unlocks a quick-release trigger. Made of high tech resin so it is light and easy to handle, Quick-Grip has large, pliable pads that won't mar work surfaces.

CAT. NO.	JAW OPENING SIZE
506QC	6" (152 mm)
512QC	12" (305 mm)
524QC	24" (610 mm)

CRL 4" Mechanic's Bench Vise

- Rugged Cast Iron Construction
- 360° Swivel Base

CAT. NO. BV4



This CRL 4" Mechanic's Bench Vise has a large anvil surface for shaping and forming. It has a 4" (102 mm) maximum jaw opening and 360° swivel base with positive locks for easy positioning. Replaceable jaws. Rugged cast iron construction with chrome plated lead screw and handle.

CRL 2" Clamp-On Bench Vise

- Rugged Cast Iron Construction
- Clamp-On 360° Swivel Base Allows Portability

CAT. NO. 305V35



This CRL 2" Bench Vise provides positive clamping for parts being put together. It also holds pipe for cutting and threading. It has a 1-3/4" (44 mm) maximum jaw opening. The 360° swivel clamp-on base has positive locks for easy positioning. It also has replaceable jaws, and is made of rugged cast iron construction with chrome plated lead screw and handle.

CRL Multi-Wedge Pry and Level Tool Set

- Three Tools for Prying, Leveling, and Wedging
- Won't Damage Soft Materials
- Fine Tip Gets Into the Tightest Gaps

new

These CRL Multi-Wedge Pry and Level Tool Sets are designed to be used in place of damaging metal tools, like chisels, screwdrivers or pry bars when trying to pry soft or brittle materials. The plastic material is perfect for when you need to protect the surface finish on delicate parts. Each set has three tools with a built-in handle and a fine tip that will get into the tightest gaps. The Black color set is intended for use with harder woods, soft metals, and similar materials. The Orange color set is for use with soft woods, plastic, rubber, and other soft materials. Tools measure 5" to 6-3/4" (152 to 170 mm) in length, and are made in the U.S.A.



CAT. NO. MW3100
For Tough Materials

CAT. NO. MW3400
For Soft Materials

CRL Makita Standard 10" Miter Saw

- Easily Transportable
- 4,600 RPM Motor



CAT. NO. LS1030

This CRL Makita Standard 10" Miter Saw is lightweight and portable enough to bring to a jobsite or move around the shop easily. It has a big cutting capacity and weighs only 24.3 pounds (11 kg) for easy portability. The big, powerful 15 amp motor develops a no load speed of 4,600 rpm, and is double insulated for operator safety. There is an electric brake for fast stopping of the blade, and a large switch lever for ease of operation. Table adjustment for cutting up to 45° left and 52° right. Standard equipment: 10 inch (254 millimeter) miter saw, cross-cut blade, socket wrench, dust bag, triangular rule, and vertical vise.

NOTE: This tool is not designed for use with abrasive cut-off wheels.

CRL Nordic 10" 100 Tooth Carbide Tipped Saw Blade

- Tooth Pattern is Triple Chip Design
- Famous Nordic Quality



CAT. NO. CSB10X100AX

Designed with the tip inserted into the blade for maximum strength, CRL Nordic Blades cut all types of aluminum, magnesium, copper, and brass, both hard coat and standard finishes. They give clean cuts with a smooth finish. This 10" (254 mm) diameter blade has 100 teeth. Arbor size is 5/8" (15.9 mm). Other sizes and special order blades are available at crlaurence.com.

NOTE: CRL Cat. No. GS29 Lubricant should be used. Always be sure the material being cut is held down securely.

CRL Bench Grinder

- Large 6" (152 mm) Diameter Wheels



CAT. NO. B6G

This CRL Bench Grinder features a lubricated for life, shielded ball bearing motor, assuring smooth grinder performance. An enclosed capacitor starts the motor. The tool rest is adjustable for height and distance from the wheels. It has adjustable spark deflectors. The motors and wheels are dynamically balanced for even rotation, and it features oval end bells and streamlined design motor for greater grinding clearance. Dust exhausts are engineered to increase airflow. The motor uses 4.2 amps at 115V AC.

CRL Air Powered Heavy-Duty Sheet Metal Nibbler

- Cuts Up to 18 Gauge Metal
- Efficient and Powerful
- Easy to Operate and Control



CAT. NO. AK80TOOL

Get a bigger bite and better angle cuts with our Heavy-Duty Air Nibbler. Instead of shearing or sawing, this tool actually "nibbles" aluminum, cold rolled steel, plastic, and an assortment of other metals up to 18 gauge in thickness. It will not distort the edges of material being cut, and is designed so you can start cuts in the center of a panel. Tool will hold a tight 1/4" (6.4 mm) radius with great accuracy. It operates using an air supply capable of 90 psi.

NOTE: To order a replacement for a worn or damaged punch, specify Cat. No. AKRP1.



CRL Premium 12" Hacksaw

- Our Finest Hacksaw
- Vertical or Horizontal Blade Positioning
- Handle Holds Extra Blades

The CRL Premium 12 Inch Hacksaw is our finest model. The strong, yet lightweight tubular steel frame has a special blade tension device to hold the blades firmly to prevent flexing and breakage. A removable pin permits horizontal cuts. The tube provides storage for extra blades. Its heavy-duty construction will give you years of quality service. Uses 12" Hacksaw Blades shown below.



CAT. NO. 24053

CRL Standard Alloy Steel 12" Hacksaw Blades

- Flexible Blade for Mild Steel, Cast Iron, Aluminum, Copper, Etc.
- Extremely Durable



CRL Standard Alloy Hacksaw Blades can cut mild steel, cast iron, aluminum, copper, etc. Their flexible body reduces breakage and eliminates shattering. The blade cuts easily and is extremely durable. For a longer lasting more durable blade try our Cobalt Blades.

CAT. NO.	LENGTH	TEETH/INCH
SL1214	12"	14
SL1218	12"	18
SL1224	12"	24
SL1232	12"	32

Minimum order is 10
Blades of one size.
100 Blades per box.

CRL High Speed Cobalt 12" Hacksaw Blades

- Highest Quality Blades with Specially Treated Cobalt Teeth
- Excellent for Cutting Steel



These CRL High Speed Cobalt Hacksaw Blades are made of the highest quality flexible steel. They have specially treated cobalt teeth that will cut almost any material, including tool and stainless steel! The very flexible body helps to prevent breakage.

CAT. NO.	LENGTH	TEETH/INCH
MB1218	12"	18
MB1224	12"	24
MB1232	12"	32

Minimum order is 10
Blades of one size.
100 Blades per box.

CRL Coarse/Smooth 10" Combination Aluminum File

- High Quality Simmonds Brand File
- Smooth on One Side, Coarse on the Other



CAT. NO. CF10

This CRL Combination File is our most popular file. It has teeth that are designed to use on aluminum and various non-ferrous metals. One side is coarse and the other side is smooth.

CRL Combination File Card and Brush

- Keeps Files Working Their Best
- Mounted on a Wooden Handle



CAT. NO. FC100

The CRL Combination File Card and Brush removes filings from aluminum files. It has 1/4" (6 mm) long metal bristles on one side, and 5/8" (16 mm) nylon bristles on the other side. Mounted on a solid wood handle for stability.

CRL Draco Inline Metal Shear

- Fast Cutting in Up to 19 Gauge Mild Steel, 24 Gauge Stainless Steel, and 18 Gauge Aluminum
- Easy One-Handed Operation
- Excellent for Sunroof and Van Window Cut-Outs



CAT. NO. SD5

This CRL Draco Inline Metal Shear provides fast cutting action (3,000 strokes per minute) for up to 19 gauge mild steel, 24 gauge stainless steel, and 18 gauge aluminum. It provides a minimum outside cutting radius of 2" (51 mm) for close right or left curve cuts with a smooth edge. Removes a continuous metal curl with no material distortion. This unit also features a sliding on/off thumb switch for easy one-handed operation.

CRL Bosch Unishear

- A Super Tool for Sunroof Cut-Outs
- Cuts Up to 14 Gauge Aluminum at 5,000 Strokes Per Minute
- Cuts Aluminum and Stainless Steel Quickly and Efficiently

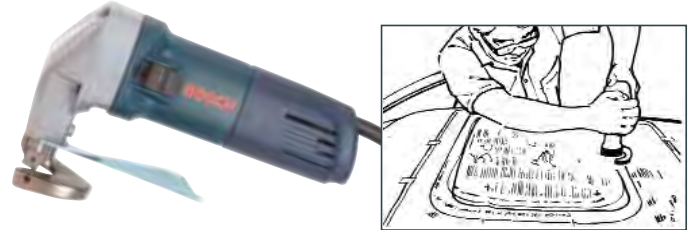

CAT. NO. B1500

The CRL Bosch Unishear Tool is a lightweight easy-to-manuever electric shear for mild and stainless steel, and aluminum. Small in size and well balanced, it is designed to cut up to 14 gauge aluminum efficiently and quickly at up to 5,000 strokes per minute. The cutting head allows full visibility of the blade so that the intended cut-out can be made precisely on the template markings. This is especially helpful when using the Unishear for sunroof cut-outs, where tolerances must be exact. Unishear is double insulated for operator safety, and plugs into grounded 115V AC outlets.

CRL Kett Electric Power Shears

- Produces Smooth, Even Cuts
- Ideal for Sunroof Installation or Metal Duct Work
- Cuts Up to 180" Per Minute



CAT. NO. K200

Save up to 90% on hand shearing time with this double cut CRL Kett Electric Power Shear. Cuts 180" (457 cm) per minute of 18 gauge and lighter sheet metal. The 3/32" (2.4 mm) waste curl leaves both sides of the cut straight and clean, with no distortion. No need to deburr. This is the ideal tool for the tinner, roofer, and auto body shop worker. Also excellent for ductwork or aluminum and steel siding installation. Replacement Center and Side Blades are available at crlaurence.com.

CRL Kett Cordless Power Shear Kit

new

- Completely Portable
- Produces Clean, Burr-Free Edges
- Ideal for Auto Body Projects



CAT. NO. KB342K

The CRL Kett Cordless Power Shear is designed to make contour cuts on 16 gauge mild steel or 18 gauge stainless. The Shear's 14.4 volt motor and close clearance heavy-duty blades provide smooth cutting action, without burring or buckling the material. The patented shearing action curls the 3/32" (2.3 mm) wide waste strip into a handy coil for fast cleanup. Powerful enough to cut truck or bus panels, metal siding or steel doors. The extended run time NiCad battery recharges quickly. The Kett Cordless Power Shear Kit includes carrying case, one NiCad battery, and one battery charger.



CRL Shop Vac® Quiet Series Wet/Dry Vac

- Powerful, Portable Hand Held Compact Design Stores Anywhere
- Quickly Converts Into a Blower

This compact yet powerful and quiet Wet/Dry Vac is great for mobile van use or any small cleanup jobs. Its compact design takes up very little room, and with onboard accessory storage, cord storage and super light weight, it travels effortlessly. Powerful 2.0 peak HP motor provides plenty of suction and quickly converts into a blower for added versatility. This 2.5 gallon Wet/Dry Vac includes the following:

- 4' x 1-1/4" Hose
- Gulper Nozzle
- Crevice Tool
- Foam Sleeve
- Reusable Dry Filter Bag
- On-Board Tool Holder



CAT. NO. 5860262
2.5 Gallon Poly Tank 2.0 HP

CRL Shop Vac® Industrial Wet/Dry Vacs

- Industrial Duty Unit with Super Quiet Longer Lasting Motor
- No Messy Filters to Change
- Improved Anti-Tip Design
- Positive Connection Hose System
- Large Top Carrying Handle
- On-Board Cord Wrap
- 18 Foot Power Cord

Both of these 10 gallon and 16 gallon capacity Shop Vac® Wet/Dry Vacs are industrial units equipped with longer lasting motors than found in consumer models. The high quality cartridge filter for wet or dry pick-up means no changing of messy filters. Both models also include a high quality drywall collection bag for fine dust pick-up, which ensures no blow-through when picking up drywall dust. Both the 10 and 16 gallon Industrial Wet/Dry Vacs include the following accessories:

- 6' x 2-1/2" Heavy Duty Hose
- Two 2-1/2" Extension Wands
- 8" Utility Nozzle
- 14" Floor Nozzle with Squeegee
- Crevice Tool
- High Quality Cartridge Filter
- Drywall Filter Bag
- Oversized On-Board Tool Storage



CAT. NO. 9254010
10 Gallon Poly Tank 3.0 HP

CAT. NO. 9254210
16 Gallon Poly Tank 5.0 HP

CRL Wood's Powr-Grip Vacuum Cups

- Pump-Actuated Vacuum
- Quick Release Trigger
- Red Indicator in Plunger Warns Against Pending Vacuum Loss

CRL proudly offers you the unique line of Wood's Powr-Grip Vacuum Cups, the safest hand vacuum cups available on the market today. These specially designed, hand actuated cups operate on a pump system, and create a vacuum under their gripping pad section. The pump plunger has a red band to indicate suction level at all times. When it shows less than 100% vacuum left, simply pump the plunger until you reach the original vacuum pressure - without removing the cup from the glass! To release, just depress a trigger on the opposite end of the handle from the plunger. There are four models of the basic Wood's Powr-Grip Vacuum Cup. All come with a vacuum-molded carrying case to protect the cup when not in use. For more information on the complete line of Wood's Vacuum Lifting Equipment, go to crlaurence.com.

The Safest Cup Made



CRL 8" Powr-Grip Flat Vacuum Cup with Metal Handle

- This is the Basic Cup Used the World Over
- Best Seller Preferred by Glaziers
- Metal Pump Cylinder and Handle
- 50 Square Inches of Gripping Surface



CAT. NO. W4950

CRL 8" Powr-Grip Flat Vacuum Cup with Lexan Handle

- High Impact Black Lexan Handle
- Economical Price
- Lightweight Storage Case
- 50 Square Inches of Gripping Surface



CAT. NO. W4000

CRL 9" Powr-Grip Flexible Edge Vacuum Cup with Metal Handle

- More Edge Flexibility Makes This Unit More Universal
- Safe and Easy to Use on Any Non-Porous Surface
- 60 Square Inches of Gripping Surface



CAT. NO. W5450

CRL 10" Powr-Grip Concave Vacuum Cup with Metal Handle

- 70 Square Inches of Gripping Surface
- Specially Designed for Curved or Irregular Surfaces
- Lightweight Storage Case



CAT. NO. W6450



CRL Brand Heavy-Duty Vacuum Cups

- Large 5" Diameter Pads
- Heavy-Duty Cast Construction
- Made by CRL in the U.S.A.

These Heavy-Duty CRL Vacuum Cups have the industry-proven design that has been a favorite of the glass industry for decades. Their cast frames have a smooth yet durable finish that resists corrosion and the abuse that comes from everyday use. The large 5" (127 mm) diameter rubber pads get a good grip on glass, marble, granite or any smooth surface material. These are a practical and affordable material handling system that will give you years of good service. They're quality made by CRL in the U.S.A.



CAT. NO. 550
Double Cup



CAT. NO. 555
Triple Cup



CAT. NO. 505
Single Cup



CAT. NO. 550A
Cross-Handle
Double Cup

CAT. NO.	DESCRIPTION	CUPS	WEIGHT CAPACITY*
505	Single Vacuum Cup	1	40 lbs. (18 kg)
550	Double Vacuum Cup	2	125 lbs. (56 kg)
550A	Cross-Handle Vacuum Cup	2	100 lbs. (45 kg)
555	Triple Vacuum Cup	3	150 lbs. (68 kg)
RR150	Replacement Rubber		

* Recommended maximum weight capacity under ideal conditions using unblemished cups on clean surfaces. Always observe safe lifting practices.

CRL Veribor Blue Line Lever-Actuated Vacuum Cups

- Four Models to Choose From
- Durable Metal Construction

CRL Veribor Blue Line Vacuum Cups are easy to use with their simple lever action. Their high quality rubber pads develop a tremendous amount of vacuum for maximum lifting power. They will adhere to any smooth, non-porous surface such as glass, mirror, steel, aluminum, laminates, and plastics. The durable metal construction and hard coating make them tough enough for everyday use, and years of reliable service. Rubber vacuum pads measure 4-5/8" (117 mm), and are easy replaced when worn or damaged.

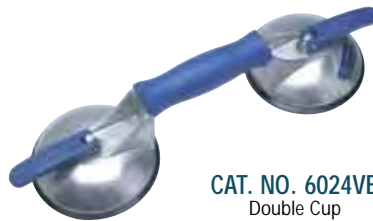

CAT. NO. 6024VB
Double Cup



CAT. NO. 6030VB
Triple Cup



CAT. NO. 6000VB
Single Cup



CAT. NO. 6020VB
Cross-Handle
Double Cup

CAT. NO.	DESCRIPTION	CUPS	WEIGHT CAPACITY*
6000VB	Single Vacuum Cup	1	66 lbs. (30 kg)
6024VB	Double Vacuum Cup	2	132 lbs. (60 kg)
6020VB	Cross-Handle Vacuum Cup	2	154 lbs. (70 kg)
6030VB	Triple Vacuum Cup	3	220 lbs. (100 kg)
V612	Replacement Rubber Pad and Trigger		

* Recommended maximum weight capacity under ideal conditions using unblemished cups on clean surfaces. Always observe safe lifting practices.

CRL Brand GripPro Impact Performance Gloves

new

- Shock Absorbing Impact-X™ Padding
- Heavy-Duty Elastic Velcro® Closure
- Lightweight and Durable RhinoTex™ Synthetic Leather Palm

CRL Brand GripPro Impact Performance Gloves provide superior protection against injury-causing shock and impact. Made with the finest materials available, they are designed to endure demanding environments while providing operator comfort. They are also machine washable.

Padded areas on our GripPro's are right where you need them, in the palm and knuckle areas. Finger tips feature G-Grip™ anti-slip traction patches for maximum grip. The breathable spandex back provides great fit and retains the glove's shape, even after repeated washings. GripPro Gloves are available in medium, large, and extra large sizes.

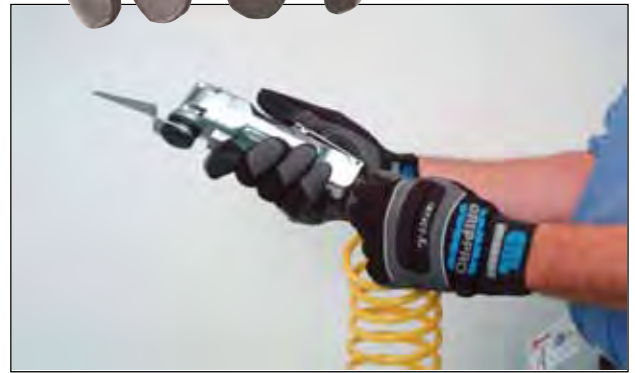

CAT. NO.	SIZE
GR1PM	Medium
GR1PL	Large
GR1PXL	X-Large



Sold only by the pair. Sizes can be combined for quantity pricing.

CRL Brand Knit Fit Gloves

new

- Comfortable Poly Cotton Knit with Durable Wrinkle Finish Palms and Fingers for a Secure Grip on All Surfaces
- Quick and Easy On and Off
- Machine Washable and Dryable

CRL Brand Knit Fit Gloves have wrinkled finish latex coated palms that are ideal for handling all smooth surfaces, even wet glass. The seamless knit liner makes them form fitting for increased comfort, and the uncoated back section allows your hand to breathe. Machine washable, CRL Brand Knit Fit Gloves will provide you with the gripping power, dexterity, durability, and protection you need on the job. Knit Fit Gloves are available in small, medium, large, and extra large sizes to fit any size hand comfortably.



CAT. NO.	SIZE
KF1TS	Small
KF1TM	Medium
KF1TL	Large
KF1TXL	X-Large



Sold only by the pair. Sizes can be combined for quantity pricing.



LOG ON TO crlaurence.com FOR BUSINESS-TO-BUSINESS SERVICES

A388 | PHONE (800) 421-6144 | FAX (800) 262-3299 TOLL FREE FROM ANYWHERE IN THE U.S.A. OR CANADA

CRL Atlas Fit Gloves



- Excellent Choice for Glass Handling
- Flexible, Form-Fitting and Ventilated
- A Great Glove for Yardwork or Household Chores

The CRL Atlas Fit Glove is perfect for light lifting situations where hand protection is needed. The poly/cotton glove is latex covered for maximum durability, and protects your hands while providing ventilation through the back and wrists. Specially formulated latex palm provides maximum wet gripping power while it guards against punctures and abrasions. Both versatile and economical, the CRL Atlas Fit Glove is a sure winner in hand protection. Four sizes available for the perfect fit. Sold only by the pair.

CAT. NO.	SIZES
300AFS	Small
300AFM	Medium
300AFL	Large
300AFXL	X-Large

CRL Fuzzy Duck® PVC Gloves

- Breathable PVC Coating Keeps Hands Cool
- Two-Piece Jersey Liner for Comfort
- Excellent Gripping Properties on Glass
- Four Sizes to Assure a Perfect Fit



CRL Fuzzy Duck® PVC Gloves have a breathable PVC coating on a soft, cool, comfortable, two-piece jersey liner. Their textured coating provides an excellent grip on glass, and minimizes absorption of water, oil and grease. Although not a true anti-vibration glove, they tend to absorb and minimize shock. Fuzzy Duck® Gloves outwear and replace cotton, light-to-medium weight leather, and goatskin gloves in a wide variety of applications. Sold only by the pair.

CAT. NO.	SIZES
962FDS	Small
962FDM	Medium
962FDL	Large
962FDXL	X-Large

CRL D-Flex® Cut Resistant Glass Handling Gloves and Sleeves

- D-Flex® has Three Times the Cut Resistance of Kevlar®, Ounce for Ounce
- Coated with Natural Rubber Dots for a Secure Grip
- Can be Laundered and Bleached without Losing Their Protective Qualities

CRL's new line of D-Flex® Cut Resistant Glass Handling Gloves and Sleeves raises the safety level for you and your crew. Made from tough Dyneema® or Spectra® fibers, these gloves and sleeves are more cut resistant and more comfortable than other products of their kind. They can be laundered and bleached over and over without losing their protective qualities. We offer D-Flex® Cut Resistant Glass Gloves in the two most popular sizes and in three material weights. D-Flex® Sleeves are 21" long, with a hook and loop fastener on top to adjust to any arm size. All D-Flex® products are sold only by the pair.

CAT. NO.	SIZE	DESCRIPTION
910CM	Medium	Light Weight D-Flex® Cut Resistant Gloves
910CL	Large	Light Weight D-Flex® Cut Resistant Gloves
917CM	Medium	Medium Weight D-Flex® Cut Resistant Gloves
917CL	Large	Medium Weight D-Flex® Cut Resistant Gloves
927CM	Medium	Heavy Weight D-Flex® Supreme Cut Resistant Gloves
927CL	Large	Heavy Weight D-Flex® Supreme Cut Resistant Gloves
927S	21" (53 cm)	Heavy Weight D-Flex® Supreme Cut Resistant Sleeves

All D-Flex® Cut Resistant Gloves and Sleeves can be combined for quantity pricing.



D-Flex® Gloves



D-Flex® Sleeves

CRL Glass and Material Handling Gloves

• Our Most Popular Styles

Natural Rubber Palm and Fingers

Wrinkle Finish Palm and Fingers



CAT. NO. 10
Knit Wrist Gloves



CAT. NO. 12
Gauntlet Cuff Gloves



CAT. NO. 63PNFW
Knit Wrist Gloves



CAT. NO. 66NFW
Gauntlet Cuff Gloves

- For Handling Glass and Sheet Metal
- Smooth Rubber Coating for Glass Use

CRL Glass Handling Work Gloves have a special natural rubber coating on the palm side. Their flexible back allows freedom for hand movement. The interior is lined for comfort with soft, fleece-like material. Available in full gauntlet cuff or loose knit wrist styles.

- For Handling Glass or Sheet Metal
- Wrinkled to Prevent Slippage

These wrinkle finish Glass Handling Gloves offer you improved wet or dry gripping. Natural rubber gives you higher cut and snag resistance, with more flexibility and increased wear. Soft lining for your comfort. Choice of a soft, loosely knitted wrist band, or with a 2-1/2" gauntlet cuff.

CRL Insulated Gloves for Glass Handling

- Cushioned Warmth and Comfort for Working in Colder Climates
- Foam Insulated

Fully insulated with a cushioned foam liner, CRL Insulated Glass Handling Gloves are ideal for working outside in cold climates, in snow, sleet or wet weather. You can also wear them and work in comfort inside cold storage or refrigerated compartments. Their highly flexible latex coating gives them high cut and snag resistance and durability. They come in knitted wrist band or gauntlet cuff styles.



CAT. NO. 93NFW
Knit Wrist Gloves



CAT. NO. 96NFW
Gauntlet Cuff Gloves

CRL Mechanix Wear® Gloves

CRL Mechanix Wear® Gloves may be most comfortable gloves you will ever work in. CRL is the exclusive distributor to the glass industry for these popular gloves. Available in three styles: M-Pact Gloves, which absorb vibration and are great for use with power tools; the original Mechanix Gloves with velcro cuffs; Fast-Fit Gloves, which offer the best value with an uncompromising fit.

- The Tool That Fits Like a Glove
- Absorb Vibration from Power Tools



- The Original with Superior Fit and Feel



- Quick On and Off Elastic Cuffs
- Best Value



CAT. NO.	DESCRIPTION	SIZE
MP010	Black M-Pact Gloves	Large
MP011	Black M-Pact Gloves	X-Large
MP012	Black M-Pact Gloves	XX-Large

Sold only by the pair.

CAT. NO.	DESCRIPTION	SIZE
MG03010	Blue Mechanix Gloves	Large
MG05010	Black Mechanix Gloves	Large
MG03011	Blue Mechanix Gloves	X-Large
MG05011	Black Mechanix Gloves	X-Large

Sold only by the pair.

CAT. NO.	DESCRIPTION	SIZE
MFF03010	Blue Fast-Fit Gloves	Large
MFF05010	Black Fast-Fit Gloves	Large
MFF03011	Blue Fast-Fit Gloves	X-Large
MFF05011	Black Fast-Fit Gloves	X-Large

Sold only by the pair.



LOG ON TO crlaurence.com FOR BUSINESS-TO-BUSINESS SERVICES

A390 | PHONE (800) 421-6144 | FAX (800) 262-3299 TOLL FREE FROM ANYWHERE IN THE U.S.A. OR CANADA

CRL Disposable Latex Rubber Gloves

- Natural Latex Rubber
- All-Purpose and Practical
- One Size Fits All and Can be Worn on Either Hand



These CRL Disposable Latex Gloves are made of natural latex rubber, and fit to give optimum touch sensitivity and finger dexterity. Molded to be worn on either hand, they have a rolled cuff that makes them easy to put on or remove. One size fits all hands. Gloves are lightly powdered for easy removal.

CAT. NO.	QTY/BOX
1005ML	100
<small>Minimum Order: 1 Box.</small>	

CRL Disposable Nitrile Gloves

- Provide Resistance Against Solvents and Other Chemicals
- Powder Free
- Exam Grade
- One Size Fits All



100% Nitrile Gloves provide better protection against solvents, and resist a broad range of chemicals where more splash protection is required than you can get with latex gloves. Nitrile compound gives greater puncture resistance than comparable natural rubber and vinyl disposable gloves, and reduces hand pressure and fatigue caused by elastomeric stress (that means they feel good on your hands).

CAT. NO.	QTY/BOX
7005NG	100
<small>Minimum Order: 1 Box.</small>	

CRL Lint-Free Nylon Gloves

- A Must for Insulating Glass Fabrication
- Keeps Fingerprints Off Glass



CRL Lint-Free Nylon Gloves are perfect for handling glass or mirrors without oily fingerprints or other contaminations. An absolute must for handling glass during insulated glass fabrication. Two sizes available to fit most anyone's hands.

CAT. NO.	SIZE
NG170	Small
NG171	Large
<small>Minimum Order: one dozen pairs.</small>	

CRL Knit Wrist Cotton Gloves

- For Light Duty Work
- Washable
- Knitted Wrist Bands



These white, CRL 100% Cotton Gloves are excellent for light duty shop work or clean up. Knitted wrist bands for easy removal. Also ideal for home and garden use. They offer only minimum protection against cuts or abrasions. Minimum Order: one pair.

CAT. NO. 8K

CRL Leather Gloves

- All Leather Palm, Thumb, Forefinger and Fingertips
- Gauntlet Cuff with Elastic Wrist Band

Heavy-duty CRL Leather Gloves with all leather palm, thumb, forefinger and fingertips. The rubberized, waterproof safety cuff, leather knuckle strap and elastic wrist band make them comfortable to wear. They offer strong, rugged protection. Minimum order: one pair.



CAT. NO. LG5231

CRL Leather Gloves

- Full Leather Palm and Thumb
- Knit Wrist for Comfort

Heavy-duty, rugged CRL Leather Gloves with split leather palm and thumb. Full canvas back and knit wrist add comfort and convenience. Minimum Order: one pair.



CAT. NO. LG1201

CRL Dual-Flex Wrist Supports

new

- Lightweight Design
- Machine Washable
- Can be Worn on Either Hand

CRL Dual-Flex Wrist Supports have a high-grade ribbed support featuring an adjustable hook and loop closure for a precise, custom fit. The soft, Ultralure lining removes perspiration, keeping hands warm and dry. The wrist supports have a lightweight design with strategically placed stays that restrict harmful flexing and extension. Available in four different sizes, Dual-Flex Wrist Supports may be worn on either hand, and are machine washable.



CAT. NO.	SIZE
25741S	Small
25741M	Medium
25741L	Large
25741XL	X-Large

CRL Nylon Wrist Protectors

- Lightweight and Flexible
- Available in Two Sizes
- Stitched with Kevlar®

CRL Nylon Wrist Protectors with improved cut resistance help protect you from cuts and abrasions. The nylon mesh provides ventilation, and two hook and loop strips make them easy to put on or take off. Great for general glaziers, window factory workers, or anybody who handles glass. Stitched with Kevlar®, they are comfortable to wear. Sold only by the pair.



CAT. NO.	LENGTH
4X2257M	7" (18 cm)
4X2259M	9" (23 cm)

CRL Fingerless Gloves

- Made of Top Grain Cowhide
- Stitched with Kevlar® Thread
- Hook and Loop Closure Around Wrist



Fingerless Gloves will help protect your palms and lower finger areas while handling glass or other sharp objects. Your finger tips are exposed enough to allow dexterity and handling. Sold only by the pair.

CAT. NO.	SIZE
FGS	Small
FGL	Large

CRL Flexx-Rap Protective Wrap for Hands and Fingers

- Waterproof, Flexible and Porous
- Self-Adhesive without Leaving Residue



Flexx-Rap is an innovative new tape that protects fingers from cuts and blisters. It also improves your grip when wrapped around fingers, tools or sporting equipment. Flexx-Rap is waterproof, flexible, porous, hypoallergenic, and self-adhesive. Flexx-Rap goes on easily and doesn't leave any residue when removed. It sticks to itself, so it won't come loose with movement, even when wet.

If you work with your hands, protect them with Flexx-Rap.

CAT. NO.	COLOR	ROLL SIZE
FR51	Blue	1" x 15 Ft.

CRL Back Belt with Suspenders

- Adjusts for Comfort
- Hook and Loop Quick Fit

Whether you are standing up, sitting down, reaching, bending, or lifting, our newest Back Belt with Suspenders gives you support where you need it. Professionally designed to reduce the possibility of back stress and injury, while encouraging proper body mechanics. Adjustable suspenders, plus hook and loop waist closure make it flexible and comfortable for extended wear. Breathable material keeps you cool.



CAT. NO.	COLOR	WAIST SIZES
5900SB	Black	Small 28" to 32"
5900MB	Black	Medium 32" to 38"
5900LB	Black	Large 38" to 46"
5900XLB	Black	X-Large 46" to 56"

CRL Weight Belt

- Sizes for Waists 28" to 46"
- Sturdy Metal Buckle
- Lightweight Yet Strong

Our 5" (127 mm) wide Weight Belt offers back support when doing heavy lifting. A single fastening system with a 2-1/2" (63.5 mm) nickel-plated double-tongue metal buckle allows fitting to your needs. This lightweight fiber-filled belt has a neoprene back support to provide additional comfort. Additional colors and sizes available on special order.



CAT. NO.	COLOR	WAIST SIZES
WBS2834	Blue	Small 28" to 34"
WBM3438	Blue	Medium 34" to 38"
WBL3842	Blue	Large 38" to 42"
WBXL4246	Blue	X-Large 42" to 46"



CRL Body-Cut Protection Garments

Kevlar® Jackets

- Provides Excellent Cut Protection
- Full Zipper Front
- Available With or Without Grommets in Body and Sleeves

CRL Kevlar® Jackets were designed for the safety of the glass worker in mind. Anyone working in the glass industry is presented with the dangers of glass on a daily basis. Wearing the proper safety gear is required in order to safely carry and install glass. These Jackets are made from 8 ounce Kevbest® Kevlar®, which is many times more cut resistant than comparable materials of the same weight. The metal eyelets in the grommet style jackets are strategically placed to provide additional cut and abrasion resistance in case of contact with a glass edge. The eyelets allow increased air circulation so your employees will be more willing to wear this jacket in warmer climates. Jacket has a zipper front for easy removal. The edges are bound for a neat, professional look. Great for window factories, too. This is something that no glazier should be without.

SIZE SELECTION DATA FOR KEVLAR® JACKETS

CHEST* MEASUREMENT	SLEEVE LENGTH	SELECT THIS SIZE JACKET
48" (122 cm)	29" (74 cm)	Small
50" (127 cm)	31" (79 cm)	Medium
52" (132 cm)	33" (84 cm)	Large
54" (137 cm)	35" (89 cm)	X-Large

*NOTE: Jackets are designed to be worn over clothing. We suggest you take chest measurements while wearing a light jacket or sweatshirt to make sure you'll have freedom of movement while wearing the Kevlar® Jacket.

See Pages A388-A390 for Glass Handling Gloves



CAT. NO.	GROMMETS	SIZE
C35GKVSM	Yes	Small
C35GKVMD	Yes	Medium
C35GKVLG	Yes	Large
C35GKVXL	Yes	X-Large

All Jackets can be combined for quantity pricing.



CAT. NO.	GROMMETS	SIZE
C35KVSM	No	Small
C35KVMD	No	Medium
C35KVLG	No	Large
C35KVXL	No	X-Large

All Jackets can be combined for quantity pricing.

CRL Kevbest® Protective Sleeves

- Top Notch Fabric with Metal Grommets for Safety



CRL Kevbest® Sleeves offer excellent protection from glass cuts and the added convenience of a lightweight Kevlar®, which is many times more cut resistant than comparable materials of the same weight. The metal eyelets are evenly spaced to help guard against deep cuts and punctures, while offering superior cooling by ventilation through the grommets. Sleeves are held on by two separate elastic straps (included) front and rear. Sold only in pairs.

CAT. NO.	SLEEVE LENGTH
S30KV25	25" (64 cm)
S30KV27	27" (69 cm)
S30KV29	29" (74 cm)

Sizes can be combined for quantity pricing.

See Pages A388-A390 for Glass Handling Gloves

CRL Kevlar® Protective Leg Chaps

- Made from Two Different Materials for Maximum Protection



- Fits Waist Sizes Up to 46" (116 cm)



CRL Kevlar® Chaps are perfect for the glazier needing that extra protection. These Protective Chaps guard against cuts and abrasions from glass and sheet metal. Made from 22 ounce Thermobest Kevlar® material at the waist, and 8 ounce Kevbest® Kevlar® legs for maximum protection and flexibility while working.

CAT. NO.	LENGTH
L49TC34	34" (86 cm)
L49TC36	36" (91 cm)
L49TC38	38" (96 cm)

Sizes can be combined for quantity pricing.

Hook and Loop closures hold the chaps to your ankles for a sure fit. Kevlar® material is lighter than leather while offering the same level of protection.

CRL Dust and Mist Respirator

- NIOSH/MSHA Approved for Dust and Mists with PEL
- Meets OSHA up to 10X PEL

For excellent balance of performance and cost, choose the CRL Dust/Mist Respirator, the first maintenance-free respirator to be approved. The ES8710 is used throughout general industry in a wide variety of applications. Protects against coal, cadmium, chromium, lead, cotton, dust, silica and other substances. NIOSH/OSHA approved for dusts and mists with PEL not less than 0.05 mg/m3. Meets OSHA Standards for use up to 10X PEL. Minimum order is one box.



CAT. NO.	QTY/BOX
ES8710	20

CRL Disposable Automotive Dust Masks

- Ideal Protection Against Dust When Sanding, Grinding and Cutting

These CRL Disposable Dust Masks protect against nuisance and nontoxic dusts, powders, pollen and other common airborne irritants. Comfortable and lightweight, they are designed to be worn with or without eyeglasses or goggles without interfering with your maximum field of vision. Ideal for sanding, grinding, and cutting. Minimum order is one box.



Caution: This mask is not suitable for use against toxic or hazardous air contaminants.

CAT. NO.	QTY/BOX
G1001	50

CRL Respirators

- Choose from Particulate (Dust) or Organic Vapor Models
- Soft, Durable Face Piece Designed for Safety and Comfort

CRL offers two types of Respirators for protection from particulates including glass grinding dust, as well as organic vapors.

The CRL ES287X Respirator comes complete with filter disks certified under NIOSH 42 CFR 84 to have a filter efficiency of 99.97% or greater against oil, non-oil aerosols, and silica (glass) dust. It also conforms to requirements for contaminants falling under OSHA substance specific standards of High Efficiency Particulate Air (HEPA) Filters.

The CRL ES285X Respirator comes with NIOSH approved cartridges for organic vapors. Common applications include degreasing, adhesive use, working with other airborne contaminants.

Particulate (Dust) Respirator and Filter Disks



CAT. NO. ES287X



Filter Disks

CAT. NO. ES286D

Minimum order is two filter disks

Organic Vapor Respirator and Cartridges



CAT. NO. ES285X



Cartridge

CAT. NO. ES286X

Minimum order is two cartridges

CRL Dry Pressurized Fire Extinguishers

- For Class A, B or C Fires

Smother fires quickly and safely with our Dry Pressurized Fire Extinguishers. Two easy-to-use sizes are available for your shop, office, home or vehicle. Both have sturdy steel cylinders with pressure gauges, and are rated to fight Class A, B or C fires.



CAT. NO.	SIZE
2025AV	2.5 Lb.
2100AH	10 Lb.

CRL 5-Pocket Machinist Apron

- Double Stitched Blue 100% Cotton Canvas

This CRL 5-Pocket Machinist Apron was designed with the machinist's needs in mind, but we found it perfect for the shop glazier. Made of heavy weight, blue 100% cotton canvas with double stitching on all pockets and stress points. Apron has two large waist pockets, two bib pencil pockets, and swing pockets for your glass cutter or running pliers.



CAT. NO. MNT27



LOG ON TO crlaurence.com FOR BUSINESS-TO-BUSINESS SERVICES

A394 | PHONE (800) 421-6144 | FAX (800) 262-3299 TOLL FREE FROM ANYWHERE IN THE U.S.A. OR CANADA

CRL Radians® Safety Eye Wear

- Great Protection
- Classic Style

CRL Radians® Classic™ Glasses feature a 100% polycarbonate lens that meets the ANSI Z87.1-1989 Standard, and is distortion-free with fog and scratch resistance built in. The adjustable temple and full 155° width provide increased protection. Minimum order is one pair.



CAT. NO. CL0210
Clear Lens



CAT. NO. CL0220
Gray Lens

CRL Radians® AV™ and Sabre™ Glasses

- 99% UV Protection
- Anti-Scratch Coating

CRL Radians® AV1110™ and Sabre™ SA2110 Glasses employ the best in eye and ear protection that meets or exceeds ANSI Standards. The lens has an anti-scratch hard coating and is 99% UV protected. They also resist fogging in all types of weather and working conditions. Each pair comes with a neck cord to hold them while not in use. JP2000 Ear Protectors are reusable, washable and conveniently replaceable. Made in the U.S.A. Minimum order is one pair.



CAT. NO. AV1110



CAT. NO. SA2110



CAT. NO. JP2000

CRL Radians® Coveralls™

- Safety and Comfort
- Economically Priced

Traditionally styled Radians® Coveralls™ give you protection at an economic price. Can be worn over prescription glasses. An excellent choice for use as "visitor" glasses. Minimum order is one pair.



CAT. NO. VS0010

CRL Lightweight Spectacles

- Wrap-Around Shields
- Distortion Free Lens

Extremely comfortable CRL Lightweight Spectacles can be worn with or without prescription glasses. They feature exclusive wrap-around side shields, and an anti-glare brow guard. The distortion free, clear lenses are .080 inch thick for added protection. Minimum order is one pair.



CAT. NO. ES461

CRL Protective Goggles

- Soft Vinyl Frame
- Distortion Free Lens

CRL Protective Goggles offer comfort and protection against flying particles, dust and splash. Injection molded from soft, pliable, non-irritating vinyl, these goggles fit all sizes and shapes, and fit comfortably even over large size prescription glasses. They have a soft vinyl frame with perforations for maximum ventilation. Optical quality, distortion-free, replaceable polycarbonate lens. Available individually boxed or bulk packed 50 per carton.



CAT. NO.	PACKAGING
ES432	1 Pair
ES435	Carton of 50 Pair

CRL Deluxe Safety Spectacles

- Designer Styling
- 99% UV Protection

CRL Deluxe Safety Spectacles have designer styling that makes them attractive as well as functional. The clear lenses provide 99% protection from UV. The soft brown plastic frames have side shields for added protection, wire-reinforced temples, and sturdy metal hinges. Certified ANSI Z87.1-1979. Minimum order is one pair.



CAT. NO. ES384

CRL First Aid Kits

Large Shop Kit

- Services 25 to 50 People
- OSHA Approved



This CRL Large First Aid Kit comes with a molded rubber gasket, providing a dust-proof, all weather seal. Complies with OSHA first aid kit requirements.

Kit Contains:

- Abdominal Pads
- Adhesive Fingertip Bandages
- Adhesive Knuckle Bandages
- Ammonia Inhalant Pads
- Antiseptic Prep Pads
- Bezalkonium Chloride Antiseptic Towelettes
- Compress Bandage (4")
- Cotton Tipped Applicators (3")
- CPR Rescue Breather with One Way Valve
- Eye Pads
- Eye Wash
- Eye Wipes
- First Aid Booklet (English/Spanish)
- First Aid Ointment
- Gauze Pads
- Hand Cleansing Towelettes
- Instant Ice Pack
- Medical Exam Gloves
- Plastic Strip Adhesive Bandages (1" x 3")
- Plastic Strip Adhesive Bandages (7/8" x 3")
- Plastic Strip Adhesive Bandages (Mini Strip)
- Rubber Elastic Bandage (2")
- Rubber Elastic Bandage (3")
- Safety Pins
- Scissors
- Sterile Gauze Bandage (2" x 6 yd.)
- Sting Stop Prep Pads
- Triangle Bandage
- Tweezers
- Weatherproof Adhesive Tape

CAT. NO. ES534

Small Shop Kit

- Services 25 People
- OSHA Approved



This CRL Small First Aid Kit comes with a molded rubber gasket, providing a dust-proof, all weather seal. Complies with OSHA first aid kit requirements.

Kit Contains:

- Abdominal Pads
- Adhesive Fingertip Bandages
- Adhesive Knuckle Bandages
- Antiseptic Prep Pads
- Bezalkonium Chloride Antiseptic Towelettes
- Eye Pads
- Eye Wash
- First Aid Instruction Card
- First Aid Ointment
- Gauze Pads
- Hand Cleansing Towelettes
- Instant Ice Pack
- Medical Exam Gloves
- Plastic Strip Adhesive Bandages (1" x 3")
- Plastic Strip Adhesive Bandages (7/8" x 3")
- Rubber Elastic Bandage
- Safety Pins
- Scissors
- Sterile Gauze Bandage (2" x 6 yd.)
- Sting Stop Prep Pads
- Triangle Bandage
- Tweezers
- Weatherproof Adhesive Tape

CAT. NO. ES530

Compact Kit

- Ideal for Mobile Use
- Compact and Convenient



Carry this CRL Compact First Aid Kit everywhere. It will come in handy on picnics, leisure time activities, or anywhere you need first aid help in a hurry. The tough and compact plastic carrying case has a convenient carrying handle, so it goes with you when you're ready.

Kit Contains:

- Bezalkonium Chloride Antiseptic Towelettes
- First Aid Ointment
- Gauze Pads
- Medical Exam Gloves
- Plastic Strip Adhesive Bandages
- Sterile Abdominal Pad
- Triangular Bandage
- Weatherproof Adhesive Tape

CAT. NO. ES529

- CRL Carries an Extensive Line of Safety Equipment and Supplies to Protect You and Your Co-Workers. For the Complete Selection, Visit the CRL Web Site at crlaurence.com

CRL Elastic Strips

- Comfortable, Breathable Strips with Non-Stick Center Pads

CRL Elastic Strips are individually wrapped, ultra-comfortable and flexible adhesive bandages with non-stick center pads. Keep a box nearby in your shop, office, home or truck. 30 each 1" by 3" strips per box. Minimum order is one box.



CAT. NO. ES164



LOG ON TO crlaurence.com FOR BUSINESS-TO-BUSINESS SERVICES

A396 | PHONE (800) 421-6144 | FAX (800) 262-3299 TOLL FREE FROM ANYWHERE IN THE U.S.A. OR CANADA



ISO 9001 Design • Engineering • Quality

Quality Built in the U.S.A.



CRL Manufacturing is a supplier to several Original Equipment Manufacturers, and many of the glass industry's major distributors. We are located in Vernon, California, just five minutes from the corporate headquarters of

C.R. Laurence Company, and ten minutes from downtown Los Angeles.

In this modern 270,000 square foot facility we build our automotive products under the most strict standards. We use progressive and certified QS-9000 manufacturing processes to ensure that we give every product our full attention to detail. Being an ISO-9001:2000 Certified company reflects the commitment of our employees. That's your assurance that when you select a product made by CRL Manufacturing you have made the best possible choice.

Ask for Them by Name

The C.R. Laurence brand name means something in the Automotive Window business - quality products. That's why so many major glass distributors, van converters, and installation facilities nationwide offer C.R. Laurence sliders, sunroofs, and van conversion windows to their customers. They know that when they install a CRL product it's going to last the life of their customer's vehicle. They know that the installation will be fast and easy, reducing labor expense and their customer's waiting time. They know that the quality materials and workmanship put into a CRL product virtually guarantees there won't be any "call-backs" or complaints to deal with. They also know that the advanced design and styling techniques used by CRL has created a window they can be proud to install, and that their customers will find pleasing to the eye. They know all this because the C.R. Laurence name is on the product, and it represents quality throughout. So when it's time to choose a slider, sunroof or van window, ask for it by the brand name that means something in this industry, C.R. Laurence.



Leadership

C.R. Laurence Company has provided new and innovative automotive accessories for more than 30 years. CRL is recognized as the premier manufacturer of sliding rear windows, including the exclusive POWR-Slider, the original electric sliding rear window for pick-up trucks. In 1988, Chevrolet began manufacturing trucks with bonded rear windows, completely changing the design and installation requirements of rear truck windows. CRL met the challenge and was the first to introduce bonded rear sliders, recognized as the industry's best. Since the introduction of bonded sliders, C.R. Laurence was also first to introduce sliders for many new trucks including the 2002 Dodge Ram, the 2004 Chevy/GMC 'C' Series, the 2003 Chevy Kodiak, and the 2004 Nissan Titan. Following these successes, CRL has introduced our latest "Perfect Fit" Slider for the 2004 Ford F-150/F-250, featuring factory-like bolt-in installation and smooth, flush appearance.

Continuing Innovation

Following the success of our new self-centering Dodge Ram Slider, we now manufacture Tri-Vents and POWR-Sliders for the 2003+ Chevy Kodiak/GMC Topkick, 2004+ Chevy Colorado/GMC Canyon, 2004+ Ford F-150, and 2004 Nissan Titan. Coming up are new models for the 2005+ Toyota Tacoma and 2005+ Nissan Frontier. Most feature our innovative "Perfect Fit" frame with the soft flange that gently hugs the contours of each truck for a 'customer satisfied' fit. All feature famous CRL quality that makes us the leader in truck sliders.

Meeting the Needs of OEM's

CRL's ISO9001: 2000 Certified manufacturing facilities produce custom windows for major original equipment manufacturers such as Ford, Toyota, Navistar, Peterbilt, Freightliner, and John Deere, and we can meet your custom window needs as well. CRL offers versatility in design, and progressive QS-9000 manufacturing processes to produce high quality windows in the shape, glass color, and operating functions that will enhance your vehicles.

Our engineers have developed many innovative products, such as our Frameless "All Glass Look" Big Rig Cab Windows with crank-out ventilating panels. We will work with you to provide windows on which you will be proud to put your name. For more information, or to discuss your custom window needs, please contact our Automotive Technical Sales Division at Extension 7780, or e-mail techsales@crlaurence.com.

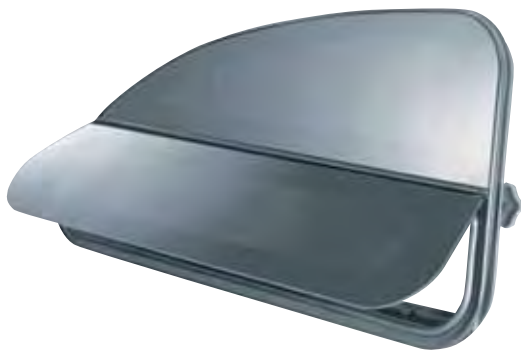

"Business-To-Business" Web Site



crlaurence.com was designed as a "business-to-business" information source that's easy to navigate because there's so much to see, and so much you can do. It's the quickest way to get product information and support, check prices and company policies, get tech bulletins, request catalogs or other literature, check the status of

your account, or even place an order. The extensive and easy-to-use A to Z Product Index guides you to over 25,000 products, with new products added weekly. You can also use NAGS numbers to look up many CRL Automotive Windows.

crlaurence.com can be viewed in English, French, Spanish, and German. There's a place where you can offer your opinions, comments, and questions. We're always glad to hear from you, and we'll do all we can to answer your questions quickly.

crlaurence.com is a constantly evolving web site that brings you information on new products, special offers, and other industry services that you can use to improve your business. We have an in-house Web Center whose mission is to add to and improve the features of the site, increasing its value to business users. It's an efficient way to order and speed delivery of what you need, and we encourage you to move up to this next level of CRL service.



LOG ON TO crlaurence.com FOR BUSINESS-TO-BUSINESS SERVICES

A398 | PHONE (800) 421-6144 | FAX (800) 262-3299 TOLL FREE FROM ANYWHERE IN THE U.S.A. OR CANADA

CRL Truck Slider Numbers

CRL's Truck Sliders have catalog numbers that are meant to help you determine the slider configuration and installation type. See the chart below for explanations that will assist with your orders and installations. Starting with older sliders and working towards the newer models, you will see how easy it is to know what you are ordering, plus what tools and products may be required.

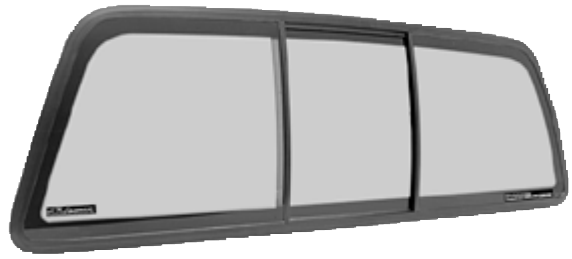

Electric POWR-Slider

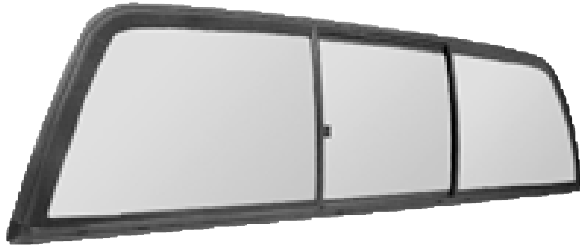

Three Panel Tri-Vent

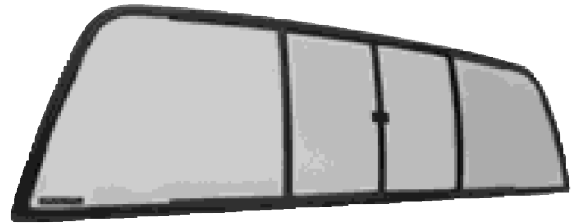

Four Panel Duo-Vent

CAT. NO. PREFIX	SLIDER TYPE	DESCRIPTION OF SLIDER	INSTALLATION
DVW	Duo-Vent	Traditional Four Panel Slider	Gasket Set
EDV	Bonded Duo-Vent	Same as DVW, but bonded to body	Urethane Bonded
TSW	Older Model Truck Slider	DVW for truck models out of production for 10 years or more	Gasket Set
BRW	Big Rig Slider	Slider for large commercial trucks	Gasket Set or Urethane Bonded
TRV	Tri-Vent	Three Panel Slider	Gasket Set
TRC	Deluxe Tri-Vent	Same as TRV, only with curved glass	Gasket Set
ETRV	Bonded Tri-Vent	Same as TRV, but bonded to body	Urethane Bonded
ECT	Deluxe Bonded Tri-Vent	Same as ETRV, only with curved glass	Urethane Bonded
PS	POWR-Slider	Electrically Powered Tri-Vent	Gasket Set
PSC	Deluxe POWR-Slider	Same as PS, only with curved glass	Gasket Set
EPS	Bonded POWR-Slider	Same as PS, but bonded to body	Urethane Bonded
EPC	Deluxe Bonded POWR-Slider	Same as EPS, only with curved glass	Urethane Bonded

Light Transmittance By Glass Type

*% Of Light Transmittance



Suffix B = Clear Glass

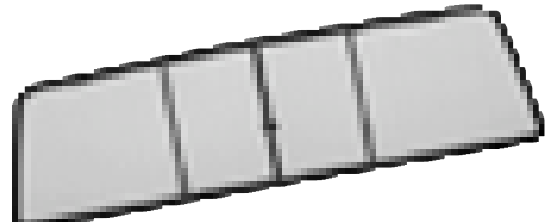

Suffix LT = 55% *Light Gray Tint Glass

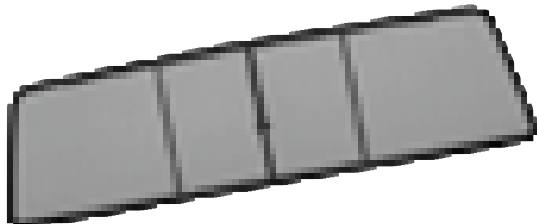

Suffix BT = 31% *Dark Gray Tint Glass

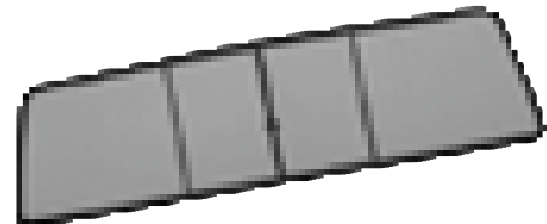

Suffix S = 28% *Solar Glass

Over 55 Years of Truck Sliders

C.R. Laurence is the only manufacturer to offer truck sliding windows to the industry for over 55 model years. We are proud to be the industry leader. Remaining on top of an ever-changing industry is a challenge, and for the 2004 model year, CRL once again meets that challenge with exciting new products. CRL has taken our most popular sliders and created the "Perfect Fit" Flexible Flange Frame. The soft rubber flange of these new sliders hugs the body of the vehicle, and guarantees a customer satisfied fit every time. This slider frame design also fits closer into the opening for that "Flush Glass" look. These new sliders are now available on the Dodge Ram and Dakota, Chevy/GMC Silverado/Sierra, Kodiak/Topkick, and Colorado/Canyon, the new Nissan Titan, and the Toyota Tundra. With truck sales at an all time high, don't be left out of the demand for the best sliders on the market. Offer CRL Sliders, and see the difference it makes to your customers.



Traditional Framed Sliders

• Exact Fit Frames

Our slider frames are contoured to match the shape of the truck cab, model by model, make by make. Our Deluxe Sliders utilize contoured frames and molded curved glass to achieve a factory appearance.

• Fade Away Silk Screen Glass Borders

Some models have silk screened fade away borders to conceal interior trim and pinchweld areas, again to achieve a factory-installed appearance.

• Our Exclusive Self-Locking Latch

Is now standard on all Tri-Vents, making opening and closing a one-finger operation.

• No Exposed Weep Holes

This new design is now available on all current model Sliders, providing a smooth, sleek appearance.

• Choice of Four Glass Colors

Clear, Light Tint, Dark Tint and Solar Privacy Glass is available on most models.

• Slimline Frame and Narrow Vertical Stiles

Allow maximum glass area and increase rear-view visibility.

• Two-Stage Glass Sliding Track

Track design provides the smoothest sliding operation and reduces wind noise.

• ABS Interior Trim Covers

Specifically for '95-'97 Dodge Ram Extended Cab and '87-'96 Dodge Dakota Extended Cab Trucks.

• Vent Weather Guard

Found on '94+ Dodge Ram and '97+ Ford F-Series, this feature conceals and protects the interior headliner when the window is open.

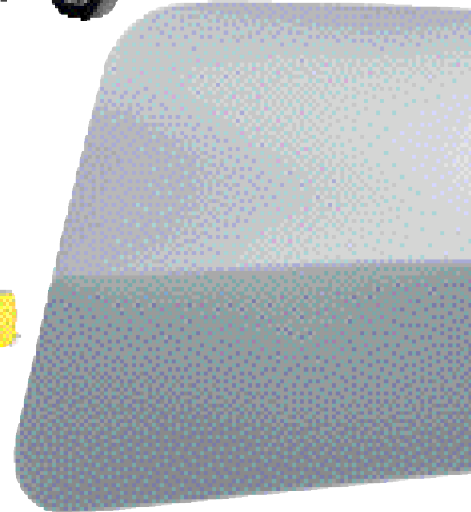

Ever Improving Quality and Features Make C.R. Laurence Today's Choice for High-Quality Automotive Windows

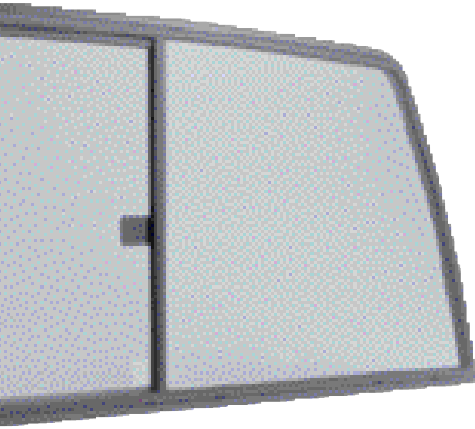

New "Perfect Fit" Low Profile Sliders

- Customer Satisfied Fit, Every Time
- Low Profile "Flush Glass" Look
- Soft Flexible Flange Hugs Body Contours
- Curved Glass Eliminates Reflection, and Follows Cab Contours

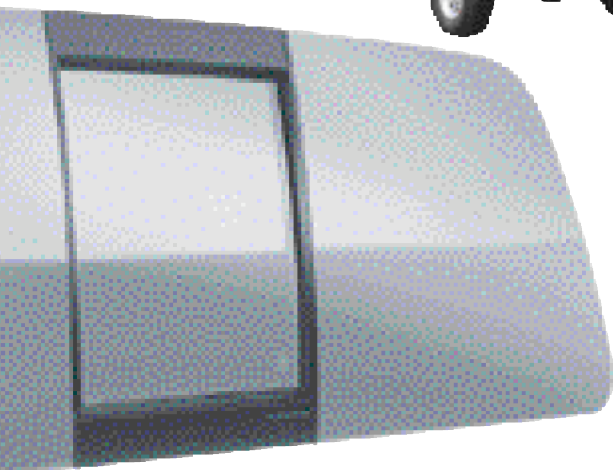

How Far Back Do We Go?

1948 ...Chevy/GMC	1978 ...Subaru
1953 ...Ford	1979 ...Mitsubishi
1963 ...International	1980 ...Volkswagen
1967 ...Datsun, Dodge, Jeep	1981 ...Isuzu
1969 ...Toyota	1986 ...Nissan
1972 ...Mazda	2002 ...Lincoln

"All Glass Look" Sliders for 1997+ Ford F-150/F-250

- **OEM-Style Appearance**
No exposed frame for a factory installed look.
- **Installs Just Like the Factory Back Glass**
Utilizes existing fasteners; bolts-in just like original equipment.
- **Curved Solar Glass Matches Body Contours**
- **Our Exclusive Self-Locking Latch**
Makes opening and closing a one-finger operation.
- **Narrow Stiles Allow Maximum Glass Area**



Another First for CRL — Next Generation Truck Sliders with a Perfect Fit

CRL has re-invigorated the truck slider market with our newest slider design. The "Perfect Fit" Slider with the Flexible Flange represents a huge step forward in truck slider design and function. Offering you a no-nonsense, trouble-free, customer satisfied fit every time. Guaranteed.

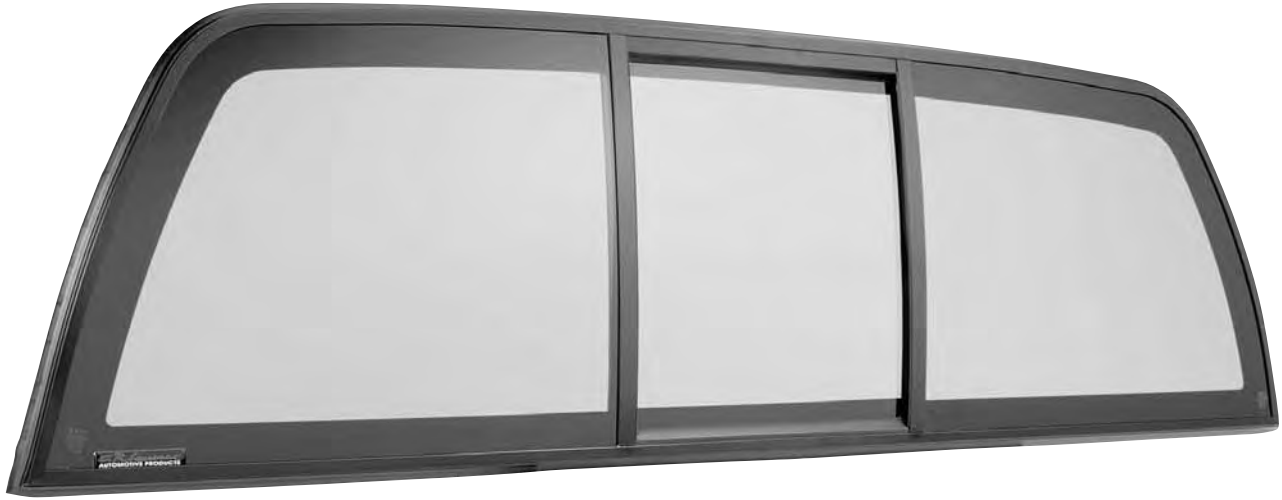

- Available in Both Manual Tri-Vent and Electrically Operated POWR-Slider Models



This design allows the bonding area of the frame to set further into the pinchweld area, with less projection on the exterior for that "flush glass look" everyone is asking for.

CRL has "Perfect Fit" Sliders available now for popular Chevy/GMC, Dodge, Ford, Nissan and Toyota trucks.

- Low Profile "Flush Glass" Look
- Curve Glass Eliminates Reflection, and Follows Cab Contours



LOG ON TO crlaurence.com FOR BUSINESS-TO-BUSINESS SERVICES

A402 | PHONE (800) 421-6144 | FAX (800) 262-3299 TOLL FREE FROM ANYWHERE IN THE U.S.A. OR CANADA

“Perfect Fit” Sliders

Sliders Then

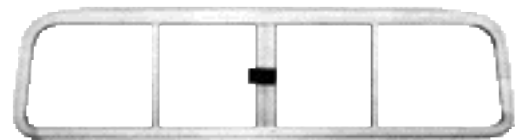
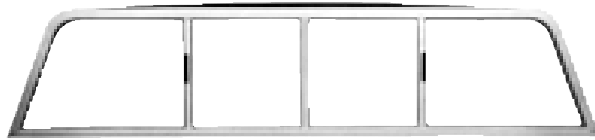

If you follow the transition that truck sliders have made through the last 30 years it's hard to believe the changes. Today's truck sliders are a completely different product than that of their predecessors. The original slider was designed more for ventilation into non-air conditioned cabs than for style. These sliders had heavy aluminum frames, filler strips, and flat clear tempered glass. Wide vertical stiles and interlocks made these sliders look almost bulletproof. If you see an old truck on the road today with one of these old sliders, you really

notice the difference when compared with current model sliders with their slim lines, smooth powder-coated frames, and dark curved glass panels.

CRL has always been an innovator in truck sliders, leading the market in new designs, and offering the most complete line in the world. Innovation has brought the truck slider of yesterday to the 21st Century, and CRL carries the torch with the introduction of our new line of “Perfect Fit” Sliders.

Sliders Now

FLEX-FLANGE DESIGN
For 1999+ Chevy/GMC Silverado/Sierra, and 2003+ Kodiak/Top Kick

FLEX-FLANGE DESIGN
For 1994+ Dodge Ram and 1997+ Dakota, 1994+ Chevy/GMC “S” Series, Toyota Tundra, and 2004+ Ford F-150

FLEX-SEAL SELF-CENTERING FRAME DESIGN
For 2002 Dodge Ram 1500, 2003 Dodge Ram 2500/3500, and 2004+ Nissan Titan

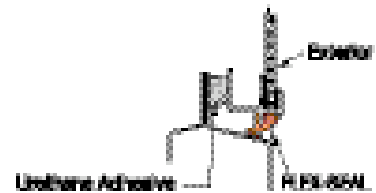
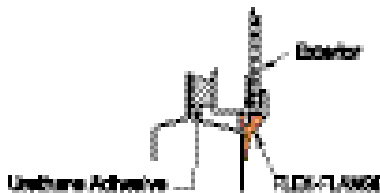

- **Soft Flexible Flange Hugs Body Contours**

Not only has the exterior design of our sliders been updated for the 21st Century, but CRL has also made installations easier. We've added bend-over tabs on the interior side of the frame for fast, easy alignment to the pinchweld, and to hold the slider in place for the

urethane bond to cure. This speeds up the installation time, makes for a trouble-free installation, and gets the truck back on the road faster. Another first from CRL, the leader in slider technology.

- **Choice of Glass Colors for Most Models**

Check out our complete truck slider selection in the following pages and see for yourself why CRL Sliders should be asked for by name when you want the finest truck sliders available.



POWR-Sliders, Tri-Vents, and Duo-Vents for New and Older Model Ford Trucks



- “Perfect Fit” Frame with Flexible Flange on New 2004+ Ford F-150
- Original Equipment Style Bolt-In Installation for 1997-2003 F-150/F-250 Models
- Choice of Up to Four Glass Colors in Our Four-Panel Duo-Vents

Ford’s F-Series trucks are the top sellers, and C.R. Laurence keeps pace with our new “Perfect Fit” Sliders with the Flexible Flange for 2004+ F-150 models and our popular “All Glass Look” Sliders for '97 to '03 F-150 and F-250 Regular Duty models. CRL Sliders for Super Duty and Ranger models also offer the latest features. Our Self-Locking Latch, exclusive to CRL Tri-Vents, allows easy, one-hand opening and closing, while our POWR-Slider offers the convenience and safety of one touch electric-powered operation. Our traditionally styled Four-Panel Duo-Vents offer the largest possible opening, and come in models to fit most popular full size and mid-size Ford pickups.

Ford POWR-Slider



Ford “All Glass Look” Tri-Vent

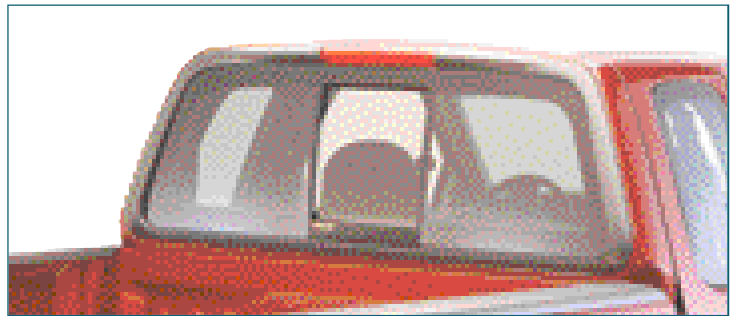

Ford Duo-Vent

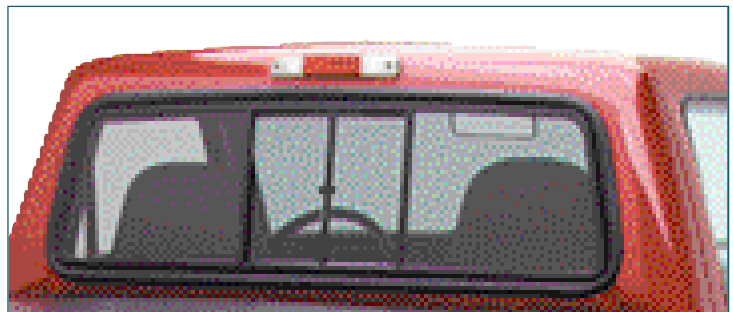

CRL 2004+ Ford F-150 Sliders

new

- OEM Style and Appearance
- Available with Full Power for the Ultimate in Convenience

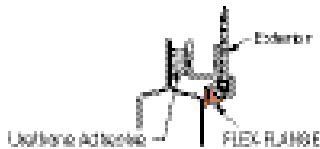
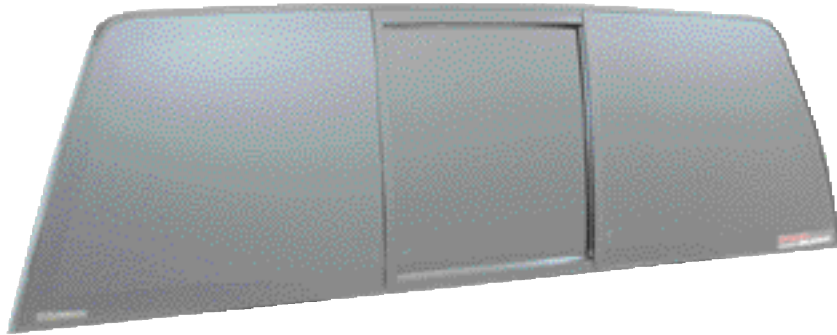

- Flexible Flange for a Perfect Fit without Modifications

America's number one selling truck, the Ford F-150, is all new for 2004. Whether your customer has a basic model for use as a work truck, or the top-of-the-line Lariat, our "Perfect Fit" Sliders will improve the look and ventilation of these big cabs. Both manual and electric models feature solar privacy glass to help keep the sun off your back. All 2004 models have four doors, and that makes our POWR-Slider the perfect accessory for this truck. The convenience of a dash-mounted switch to open and close the rear slider is something truck owners will want. Best of all, these new sliders have our years of experience as the premier builder of quality sliders for America's trucks.



YEARS	MODEL	THREE PANEL CRL TRI-VENT			POWR-SLIDER
		LIGHT TINT	SOLAR	SOLAR	SOLAR
2004+	New F-150	ECT994LT	ECT994S	EPC994S	EPC994S

See Page A410 for a Complete Listing of All Ford Models.

CRL 1997-2003 F-150/F-250 Light Duty, Super Crew, 2004+ Heritage, and 2002-2003 Lincoln Blackwood Sliders

- OEM Style "All Glass Look" with No Visible Frame
- Close-Fitting Tolerance Ensures "Gap Free" Fit
- Installs Just Like the Factory Backglass

Our sliders for these popular Fords have an OEM "All Glass Look" with no visible frame around the window. Features include curved glass technology; black silk screen frit edges, and our exclusive Self-Locking Latch for convenient one-hand operation. It installs without modifications to the cab interior, with close-fitting tolerances to ensure an OEM fit. This is one of the easiest installations to perform, and we provide the butyl tape kit needed for an OEM seal. For the ultimate in convenience, we suggest the electrically operated Deluxe POWR-Slider.

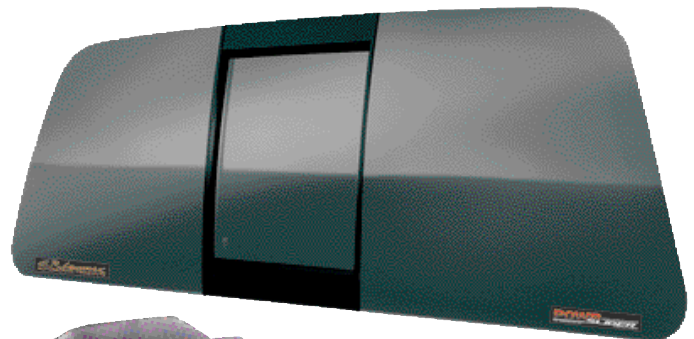

This Slider also fits the 2002+ Lincoln Blackwood

YEARS	MODEL	THREE PANEL CRL TRI-VENT			POWR-SLIDER
		CLEAR	LIGHT TINT	SOLAR	SOLAR
1997-2003	F-150/250 Light Duty, Super Crew	ECT990B	ECT990LT	ECT990S	EPC990S
2004	F-150 Heritage	ECT990B	ECT990LT	ECT990S	EPC990S
2002-2003	Lincoln Blackwood	ECT990B	ECT990LT	ECT990S	EPC990S

See Page A410 for a Complete Listing of All Ford/Lincoln Models.



CRL 1999+ Ford F-250HD, F-350, F-450, and F-550; 2000+ F-250, F-650, and F-750 Super Duty Truck Sliders

- Gasket Set, Fully Contoured, Black Powder-Coated Aluminum Frame Fits Cab Without Modifications
- Solar Privacy Glass

CRL Sliders are perfect to replace the OEM glass for these Super Duty trucks. Our Sliders have many innovative features that only CRL, the leader in truck sliders, can offer. From curved solar privacy glass surrounded by a black finish aluminum frame that fits without modifications, to our exclusive Self-Locking Latch for convenient one-hand operation. CRL Sliders install without modifications to the cab interior, with close-fitting tolerances to ensure an OEM fit. This is one of the easiest installations to perform, even for the first time installer.

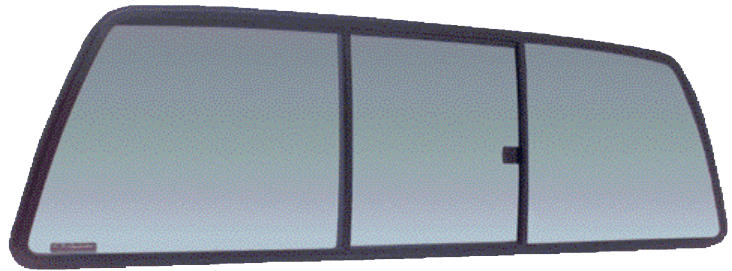

YEARS	MODEL	THREE PANEL CRL TRI-VENT		POWR-SLIDER	GASKET
		SOLAR		SOLAR	
1999+	F-Series Super Duty	TRC998S		PSC998S	WBL450*

See Page A410 for a Complete Listing of All Ford Models. *Gasket included with POWR-Slider.

CRL 1998+ Ranger and 1999+ Ranger Quad Sliders

- Fully Contoured, Black Powder-Coated Aluminum Frame with Narrow Stiles and Tight-Sealing Weatherstrip
- Three or Four Panel Sliders in Up to Three Glass Colors

CRL's Sliders are designed to integrate beautifully with today's luxurious truck cab interiors, as if they were original equipment. CRL manufactures sliders in the most popular frame styles and glass colors for the Ford Ranger, giving you the product depth you need to satisfy your customer's requests. Three Panel Tri-Vents and Four Panel Duo-Vents, along with our patented POWR-Slider, will cover just about any Ranger owner's needs.

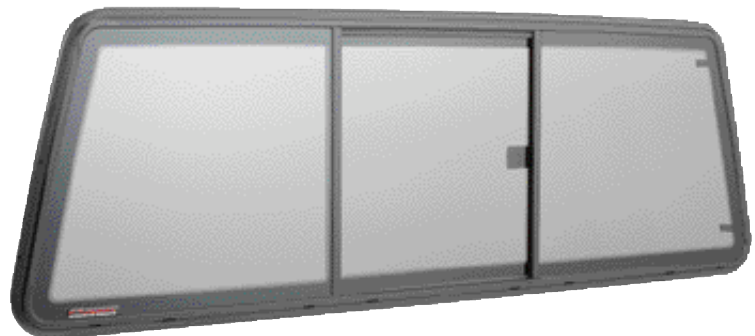

YEARS	MODEL	FOUR PANEL CRL DUO-VENT		THREE PANEL CRL TRI-VENT			POWR-SLIDER
		CLEAR	DARK TINT	LIGHT TINT	DARK TINT	SOLAR	SOLAR
1998+	All Ranger	EDV965B	EDV965BT	ETRV965LT	ETRV965BT	ETRV965S	EPS965S
1999+	Ranger Quad	EDV965B	EDV965BT	ETRV965LT	ETRV965BT	ETRV965S	EPS965SQ

See Page A410 for a Complete Listing of All Ford Models.



CRL 1997-1998 Ford F-250 Heavy-Duty/F-350 2-Door Standard, Super and 4-Door Crew Cab Sliders

- Available in Duo-Vent, Tri-Vent, or POWR-Slider
- Fully Contoured, Black Powder-Coated Aluminum Frame
- Some Models in Up to Four Glass Colors

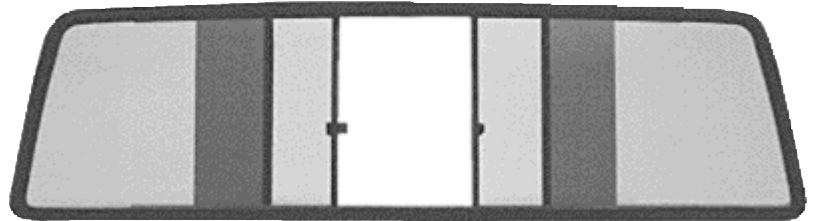

These heavy-duty sliders are made with fully contoured, thin profile, powder-coated aluminum frames with narrow stiles for maximum rear view, and tight-sealing weatherstrips to protect the interior. If you want a slider with better than factory quality style and function, insist on sliders manufactured by C.R. Laurence.



YEARS	MODEL	CLEAR	FOUR PANEL CRL DUO-VENT				THREE PANEL CRL TRI-VENT			POWR-SLIDER DARK TINT	GASKET
			LIGHT TINT	DARK TINT	SOLAR	DARK TINT	SOLAR				
1997-1998	F-250/F-350 Heavy-Duty	DVW950B	DVW950LT	DVW950BT	DVW950S	TRV950BT	TRV950S	PS950	WBL1158		

See Page **A410** for a Complete Listing of All Ford Models.

CRL 1983-1997 Ranger and 1986-1997 Ranger Super Cab Sliders

- Fully Contoured, Black Powder-Coated Aluminum Frame with Tight-Sealing Weatherstrip
- Three or Four Panel Sliders in Up to Three Glass Colors

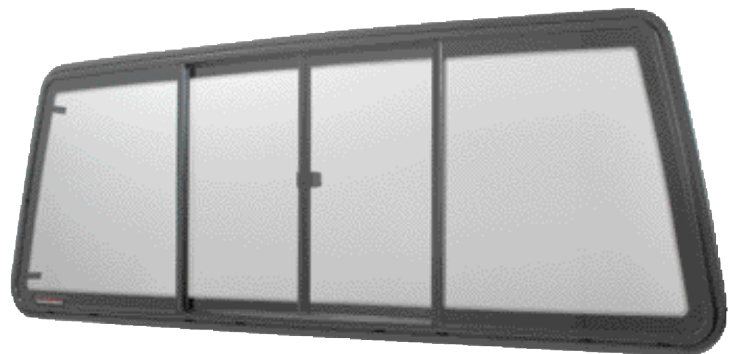

CRL's Sliders are designed to integrate perfectly into this popular Ford truck, and come in the most popular frame styles and glass colors. Three Panel Tri-Vents and Four Panel Duo-Vents, plus our electrically-operated POWR-Sliders are all available for these very popular Ford trucks.



YEARS	MODEL	FOUR PANEL CRL DUO-VENT			THREE PANEL CRL TRI-VENT			POWR-SLIDER		GASKET
		CLEAR	LIGHT TINT	DARK TINT	LIGHT TINT	DARK TINT	SOLAR	DARK TINT	SOLAR	
1983-1997	Ranger Standard	DVW1200B	DVW1200LT	DVW1200BT	TRV1200BT	TRV1200S	PS1200		WBL1163	
1986-1997	Ranger Super	EDV965B	EDV965LT	EDV965BT	ETRV965LT	ETRV965BT	ETRV965S	EPS965S		

See Page **A410** for a Complete Listing of All Ford Models.

CRL OEM Sliders for 1973-1996 Ford F-Series and 1983-1997 Ranger Standard Cab

- Replaces "Original" OEM Sliders
- Pre-Set in Gasket for Fast and Easy Installation
- Available in Light Green and Dark Gray Tint Glass

CRL OEM Replacement Truck Sliders let you offer your customers an OEM styled gasketed slider at a reduced cost. These sliders are built with a fully integrated frame within the gasket for quick and easy rope-in installation, and a straight from the factory look. Your choice of light green tint or dark gray tint glass is available for either truck.



YEARS	MODEL	FOUR PANEL OEM SLIDER	
		LIGHT GREEN TINT	DARK GRAY TINT
1983-1997	Ranger Standard	7140ET	7140EP
1973-1996	F-Series	7130ET	7130EP

See Page **A410** for a Complete Listing of All Ford Models.

CRL Sliders for Popular Older Ford Trucks

- Fully Contoured, Black Powder-Coated Aluminum Frame with Tight-Sealing Weatherstrip
- Some Models Available in Up to Four Glass Colors

These CRL Sliders fit the tens of thousands of older Ford F-Series trucks still on the job. They have state-of-the-art fully contoured, thin profile, powder-coated aluminum frames with narrow stiles for maximum rear view, and tight-sealing weatherstrips to protect the interior, plus tempered safety glass in up to four color choices. These features make CRL Sliders stand out from any others. If you want a slider with better than factory quality and function for an older model Ford, insist on sliders manufactured by C.R. Laurence.



YEARS	MODEL	CLEAR	FOUR PANEL CRL DUO-VENT		SOLAR	THREE PANEL CRL TRI-VENT		POWR-SLIDER DARK TINT	GASKET
			LIGHT TINT	DARK TINT		DARK TINT	SOLAR		
1973-1996	F-Series	DVW950B	DVW950LT	DVW950BT	DVW950S	TRV950BT	TRV950S	PS950	WBL1158 WBL1089
1967-1972	All	TSW200B	TSW200LT	TSW200BT					

See Page **A410** for a Complete Listing of All Ford Models.



CRL Sliders for Ford Golden Oldies

- Models for Ford Trucks as Far Back as 1953
- Specially Built for These Classic Older Fords

CRL has sliders for virtually any Ford pickup on the road. All feature smooth operating contoured frames with a long-lasting black powder-coated finish. It's our attention to the details that make our Oldies Sliders so special. So if you want a slider with better than factory quality style and function, choose sliders manufactured by C.R. Laurence.

When replacing the back glass in an older pickup, it's not uncommon for the old gasket to be worn and cracked. If so, it may not withstand the stretching that comes with a new installation. We have Replacement Gaskets for just such an occasion. See the chart below for gasket catalog numbers to match the slider being ordered.



YEARS	MODEL	FOUR PANEL CRL DUO-VENT			GASKET
		CLEAR	LIGHT TINT	DARK TINT	
1977-1982	Courier		TSW375LT	TSW375BT	WBL1148
1976.5-1977	Courier			TSW1319T	
1972-1979	Ranchero			TSW1750T	
1972-1976	Courier	TSW1810			WBL1052
1961-1966	All	TSW1450			
1957-1960	All	TSW1827		TSW1827T	
1953-1956	All			TSW1826T	WBL1103



See Page **A410** for a Complete Listing of All Ford Models.

CRL Ford Side-Sliders for SUV's

- Replace Original Equipment Fixed Side Glass
- No Modifications Required for Installation

The CRL Side-Slider replaces original equipment fixed side glass in many older model sport utility vehicles. They fit the original gasket and opening, so no modifications are required for installation. These fully framed sliders have 31% dark gray tinted, D.O.T. approved glass surrounded by a black finish extruded aluminum frame. Sliding panels operate easily: open for cooling ventilation; closed for security. Locking latches are included for safety. The Side-Slider's rugged construction will withstand rough off-road use, and full weatherstripping will prevent rattling while keeping drafts out of the interior. Sold only by the pair.



YEARS	MODEL	TYPE	CAT. NO.
1980-1996	Bronco	2 Panel	MSS909
1966-1977	Bronco	2 Panel	MSS404



CRL Ford/Lincoln Truck Slider Application Guide



YEARS	MODEL	FOUR PANEL CRL DUO-VENT				THREE PANEL CRL TRI-VENT				CRL POWR-SLIDER	GASKET
		CLEAR	LIGHT	DARK	SOLAR	CLEAR	LIGHT	DARK	SOLAR		
2004+	New F-150								ECT994S	EPC994S	
2004+	F-150 Heritage					ECT990B	ECT990LT		ECT990S	EPC990S	
2002-2003	Lincoln Blackwood					ECT990B	ECT990LT		ECT990S	EPC990S	
2000+	F-250/F-650/F-750 4 Door Crew								TRC998S	PSC998S	WBL450
1999+	F-250 HD, F-350 4 Door Crew								TRC998S	PSC998S	WBL450
1999+	Ranger Quad	EDV965B		EDV965BT			ETRV965LT	ETRV965BT	ETRV965S	EPS965SQ	
1998+	All Ranger	EDV965B		EDV965BT			ETRV965LT	ETRV965BT	ETRV965S	EPS965S	
1997-1998	F-250/F-350 2-DR, Super and 4-DR Crew Cabs	DVW950B	DVW950LT	DVW950BT	DVW950S			TRV950BT	TRV950S	PS950	WBL1158
1997- 2003	F-150/F-250 Light Duty All Trucks					ECT990B	ECT990LT		ECT990S	EPC990S	
1986-1997	Ranger Super	EDV965B		EDV965BT			ETRV965LT	ETRV965BT	ETRV965S	EPS965S	
1983-1997	Ranger Standard	DVW1200B	DVW1200LT	DVW1200BT				TRV1200BT		PS1200	WBL1163
1983-1997	Ranger Standard		7140ET Δ	7140EP Δ							Provided
1977-1982	Courier		TSW375LT	TSW375BT							WBL1148
1976.5-1977	Courier			TSW1319T							
1973-1996	F-Series	DVW950B	DVW950LT	DVW950BT	DVW950S			TRV950BT	TRV950S	PS950	WBL1158
1973-1996	F-Series		7130ETΔ	7130EPΔ							Provided
1972-1979	Ranchero			TSW1750T							
1972-1976	Courier	TSW1810									
1967-1972	All	TSW200B	TSW200LT	TSW200BT							WBL1089
1961-1966	All	TSW1450									WBL1052
1957-1960	All	TSW1827		TSW1827T							WBL1015
1953-1956	All			TSW1826T							WBL1103

Δ OEM Style Replacement Slider. Please Refer to Pages A434-A441 for a Complete Application Guide Listing All Makes and Models.

SFC/CRL Sunroofs

- Quality, Variety, and Ease of Installation



See Pages A450-A456 for a Complete Listing of All SFC/CRL Sunroofs.

SFC/CRL Sunroofs offer quality, variety, and ease of installation. From the traditional styling of the AutoPort, the contemporary styling of the NewPort, and all the way to the Genesis, the most advanced pop-up sunroof in the industry, SFC/CRL offers an "open air" application for just about any pickup.



NewPort



AutoPort



LOG ON TO crlaurence.com FOR BUSINESS-TO-BUSINESS SERVICES

A410 | PHONE (800) 421-6144 | FAX (800) 262-3299 TOLL FREE FROM ANYWHERE IN THE U.S.A. OR CANADA

Gasket Installed Rear Glass

- Push Out Rear Glass and Gasket
- Clean Pinchweld Area Before Re-Installing Gasket
- Install Gasket Around Slider
- Insert 1/8" Nylon Rope in Gasket Channel
- Fit Slider Into Opening
- Pull Rope Ends to Lift Lip of Gasket Over Pinchweld



Push Out Rear Glass

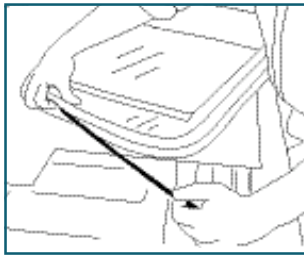

Insert Rope

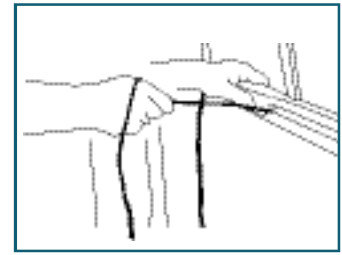

Fit Slider and Pull Rope



CAT. NO. RT752
Rope Installation Tool



CAT. NO. CP253
Hook Tool



CAT. NO. DV1K
Slider Installation Kit



CAT. NO. CRL216
Tapered Tip Stick Tool



CAT. NO. CRL220
Chisel Tipped Stick Tool

Bonded Rear Glass

- Remove Rear Glass Using Power Cut-Out Tool
- Trim Existing Urethane Bead
- Dry-Fit Slider to Check for Proper Fit
- Prep Cab and Prime Frame with Appropriate Urethane Primer
- Apply New Bead of Urethane
- Place Slider Into Opening, Then Bend Tabs or Install Clips



Cut Out Rear Glass

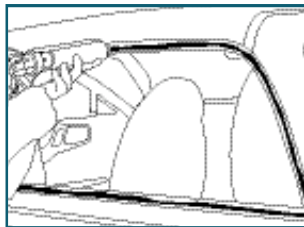

Apply Urethane

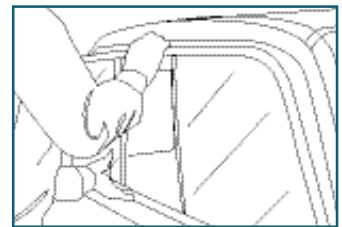

Secure Slider Into Opening



CAT. NO. AK70



CAT. NO. CG482N1



CAT. NO. CRL900HV



CAT. NO. BST1

Bolted-In Rear Glass

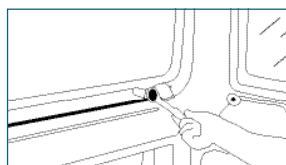

Remove Nuts

- Remove Nuts Holding Rear Glass
- Push Out Rear Glass and Remove Existing Butyl
- Dry Fit Slider to Check for Proper Fit
- Apply Butyl to Frame
- Place Slider Into Opening
- Re-Install Nuts to Secure Slider

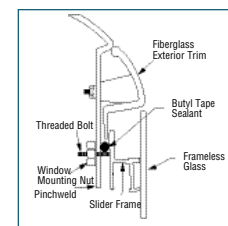

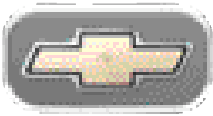

POWR-Sliders, Tri-Vents, and Duo-Vents for New and Older Model Chevy/GMC Pickups

Chevy/GMC POWR-Slider

- Automatically Locks in Position When You Release the Switch
- Slim Line Three Panel Design
- Quiet and Fast Micro Drive Motor
- Dark Tint or Solar Privacy Glass
- "Perfect Fit" Frame with Flexible Flange on Selected Models

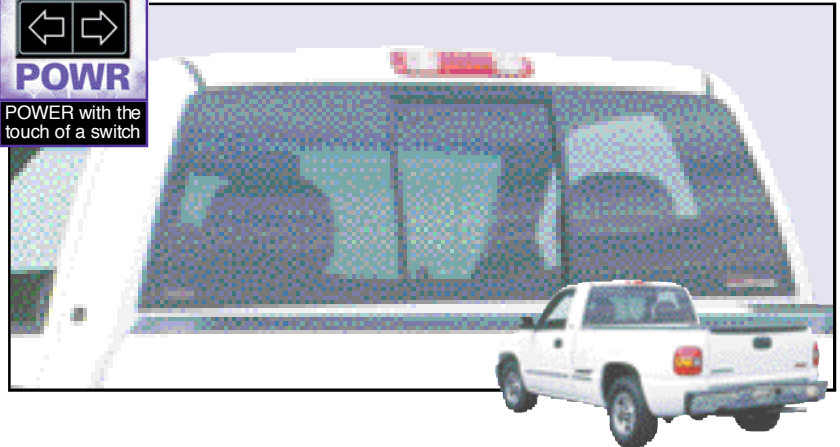

Chevy/GMC Tri-Vent

- Original Equipment Three Panel Design
- Up to Three Glass Color Choices
- "Perfect Fit" Frame with Flexible Flange on Selected Models
- Exclusive Self-Locking Latch
- Slim Line Frame Provides Greatest Visibility

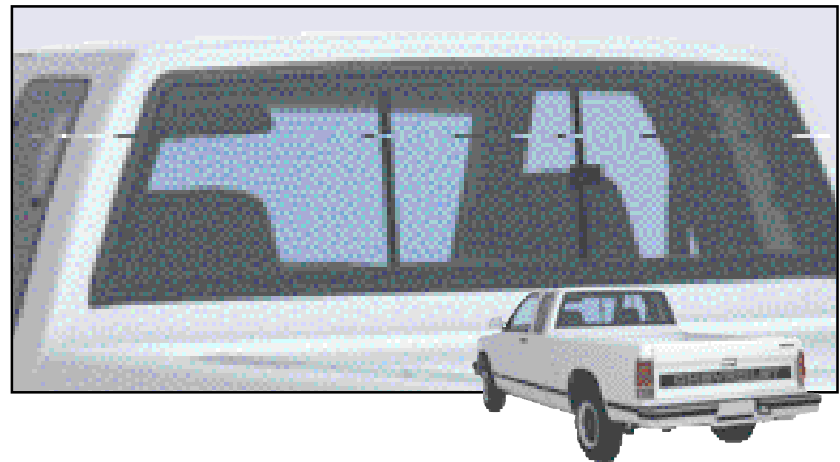

Chevy/GMC Duo-Vent

- Classic Four Panel Design with the Largest Pass Through Opening
- Up to Four Glass Color Options on Some Models
- Metal Locking Latches for Security

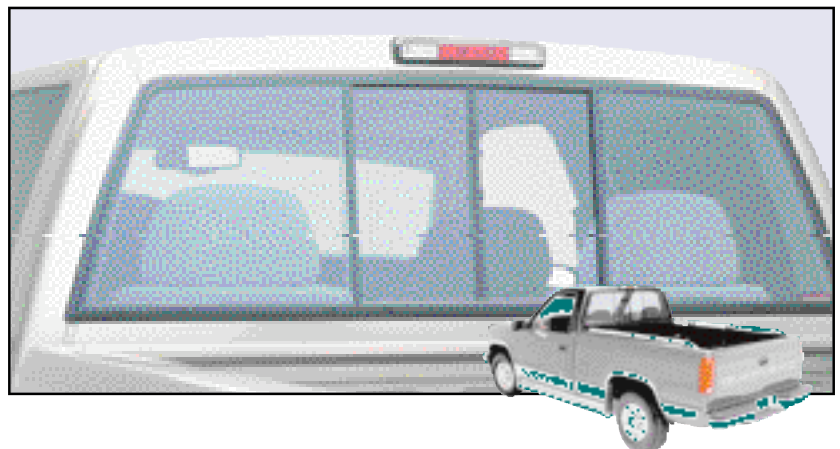

CRL 2004+ Chevy/GMC Colorado/Canyon Sliders **new**

- OEM Style and Appearance
- Solar Privacy Glass Opens or Closes Quietly
- Fully Contoured "Perfect Fit" Frame with Flexible Flange

After 10 successful years as one of America's most popular mid-sized trucks the Chevy/GMC 'S' Series was replaced by the Colorado/Canyon mid-size truck. CRL has "Perfect Fit" Sliders for these trucks featuring sleek lines, black powder-coated frames for a long-lasting finish, and smooth operation. All CRL Sliders are inspected to meet strict tolerances and specifications that are required for maintaining CRL's QS-9000 quality rating. If you want a slider that has better than factory quality, style and function, insist on sliders manufactured in the U.S.A. by C.R. Laurence.

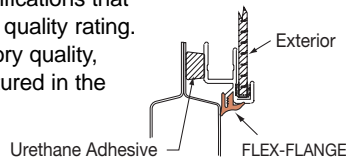

YEARS	MODEL	THREE PANEL CRL TRI-VENT			POWR-SLIDER SOLAR
		CLEAR	LIGHT TINT	SOLAR	
2004+	Colorado/Canyon	ECT804B	ECT804LT	ECT804S	EPC804S

See Page A417 for a Complete Listing of All Chevy/GMC Models.

CRL 2003+ Chevy/GMC Kodiak/Topkick Sliders **new**

- OEM Style and Appearance for This Big New Truck
- "Perfect Fit" Frame with Flexible Flange
- Solar Privacy Glass

The big Kodiak/Topkick was new to the truck market in 2003. This heavy-duty truck is a favorite of fifth-wheel owners, tow truck operators, and other specialty markets. CRL has paid careful attention to detail on our new "Perfect Fit" Tri-Vent Truck Slider for the Kodiak/Topkick. The flexible soft rubber flange hugs the contours of the body, conceals the weep holes, and helps to reduce road noise. This CRL Slider has bend-over mounting tabs that align the slider in the opening and provide a quick securing system.

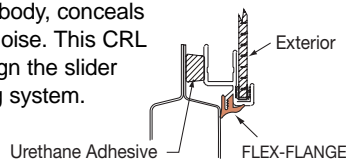

YEARS	MODEL	THREE PANEL CRL TRI-VENT		POWR-SLIDER SOLAR
		SOLAR	SOLAR	
2003+	Kodiak/Topkick	ETRV877S		EPS877S

See Page A417 for a Complete Listing of All Chevy/GMC Models.

CRL 1999+ Chevy/GMC Silverado/Sierra Sliders

- The Original Fully Contoured "Perfect Fit" Frame
- Flexible Flange, Narrow Stiles, and Tight-Sealing Weatherstrip for OEM Style and Appearance

This is one of our best selling sliders, the first of our "Perfect Fit" Tri-Vent Truck Sliders with the exclusive Flexible Flange that provides a customer satisfied fit every time. The flexible soft rubber flange hugs the contours of the body, conceals weep holes, and helps to reduce road noise. This design provides larger viewing area than factory glass, and our new bend-over mounting tabs provide for faster installations. They align the slider in the opening, providing a quick securing system for these bonded sliders.

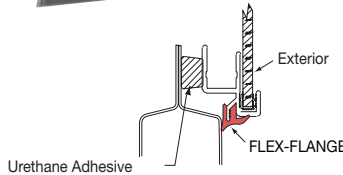

YEARS	MODEL	THREE PANEL CRL TRI-VENT			POWR-SLIDER SOLAR
		CLEAR	LIGHT TINT	SOLAR	
1999+	Silverado/Sierra	ECT899B	ECT899LT	ECT899S	EPC899S

See Page [A417](#) for a Complete Listing of All Chevy/GMC Models.

CRL 1988 – 2000 Chevy/GMC 'C/K' Series Sliders

- Available in Duo-Vent, Tri-Vent, and Electric POWR-Slider Models
- Curved Profile Matches Body Contours
- State-of-the-Art Powder-Coated Frame

There are more Chevy/GMC Trucks on the road today than ever before, and this model is one of the most popular. CRL has a full line of sliders to fit this truck, all featuring sleek lines, black powder-coated frames for a long-lasting finish, and smooth operation. All CRL Sliders are inspected to meet strict tolerances and specifications required to maintain our QS-9000 quality rating. From the traditional gasket-mounted to the contemporary bonded installation, if you want a slider with better than factory quality, style, and function, insist on sliders manufactured in the U.S.A. by C.R. Laurence.



YEARS	MODEL	CLEAR	FOUR PANEL CRL DUO-VENT			THREE PANEL CRL TRI-VENT		POWR-SLIDER SOLAR
			LIGHT TINT	DARK TINT	SOLAR	DARK TINT	SOLAR	
1988-2000	'C/K' Cabs	EDV880B	EDV880LT	EDV880BT	EDV880S	ETRV880BT	ETRV880S	EPS880

See Page [A417](#) for a Complete Listing of All Chevy/GMC Models.



CRL 1994+ 'S' Series Sliders

- Fully Contoured "Perfect Fit" Frame with Flexible Flange
- Narrow Stiles and Tight-Sealing Weatherstrip
- OEM Style and Appearance

Sliders with CRL's exclusive "Perfect Fit" Frame are made to fit this very popular mid-size truck from Chevy/GMC in either our manual Tri-Vent or electrically operated POWR-Slider models. CRL's Sliders feature sleek lines, black powder-coated frames, and smooth operation. All CRL Sliders are inspected to meet strict tolerances and specifications required for maintaining CRL's QS-9000 quality rating. If you want the best slider for the 'S' Series truck, you can't go wrong with this slider made in the U.S.A. by C.R. Laurence.

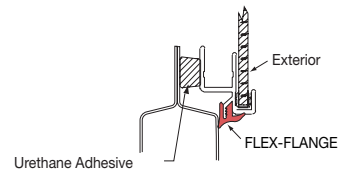
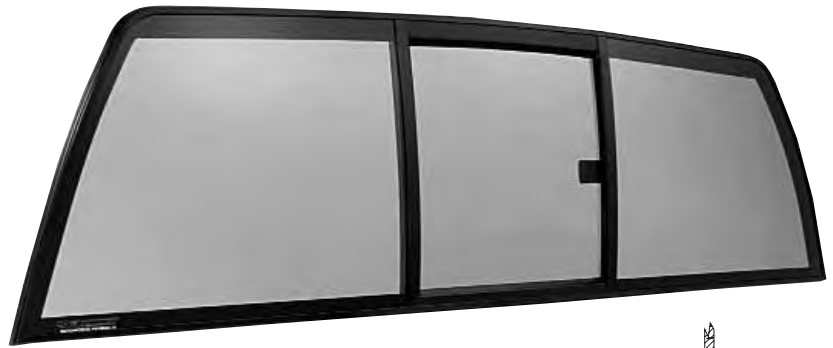

YEARS	MODEL	THREE PANEL CRL TRI-VENT			POWR-SLIDER
		CLEAR	LIGHT TINT	SOLAR	SOLAR
1994-2003	'S' Series	ECT894B	ECT894LT	ECT894S	EPC894S

See Page A417 for a Complete Listing of All Chevy/GMC Models.

CRL's Most Popular Chevy/GMC Oldies Sliders

- Models for Trucks as Far Back as 1967
- 1988 – 1992 'R/V' Cab
- 1982 – 1993 'S' Series
- 1973 – 1987 'C/K' Cab
- 1967 – 1972 Standard Cab



CRL provides you with over 56 model years of Chevy/GMC Truck Sliders. That is quite a depth in product range and something CRL is happy to offer our customers. Our standard features (sleek lines, black powder-coated frames for a long-lasting finish, and smooth operation) are all trademarks of CRL Sliders. Every one is inspected to meet strict tolerances and specifications required to maintain our QS-9000 quality rating.

YEARS	MODEL	CLEAR	FOUR PANEL CRL DUO-VENT		SOLAR	POWR-SLIDER
			LIGHT TINT	DARK TINT		DARK TINT
1988-1992	'R/V' Cabs	TSW850B	TSW850LT	TSW850BT		PS850
1982-1993	S-10/S-15	TSW875B	TSW875LT	TSW875BT	TSW875S	PS875
1973-1987	'C/K' Cabs	TSW850B	TSW850LT	TSW850BT		PS850
1967-1972	Standard Cab	TSW100B	TSW100LT	TSW100BT		PS100

See Page A417 for a Complete Listing of All Chevy/GMC Models.



CRL Sliders for Classic Chevy/GMC Pickups

- Models Specially Built for Classic Older Trucks as Far Back as 1948
- Powder-Coated Aluminum Frames
- Narrow Stiles and Tight-Sealing Weatherstrip

Classic older trucks are being pampered and painted for that Saturday night drive, and CRL truck sliders are keeping their cabs cooler with the extra ventilation only a truck slider can provide. All the great features found in our sliders for today's trucks can be found in these models for classic Chevy/GMC pickups as far back as 1948. All fit the original cab opening without modification.

When replacing the back glass in an older pickup, it's not uncommon for the old gasket to be worn and cracked. If so, it may not withstand the stretching that comes with a new installation. We have Replacement Gaskets for just such an occasion. See the chart below for gasket catalog numbers to match the slider being ordered.

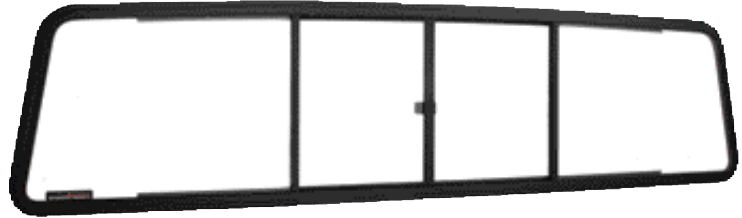

YEARS	MODEL	FOUR PANEL CRL DUO-VENT			GASKET
		CLEAR	LIGHT TINT	DARK TINT	
1981-1983	Luv	TSW575B	TSW575LT	TSW575BT	
1973-1977	El Camino/Sprint			TSW1824T	
1972-1980	Luv	TSW550B	TSW550LT	TSW550BT	
1968-1972	El Camino/Sprint			TSW1823T	
1967-1972	Small Window	TSW1832			WBL1091
1960-1966	Custom Cab	TSW1825			WKT6266
1960-1966	Small Window	TSW1816			WKT4266
1955.5-1959	Standard Cab			TSW1835T	WKT4266
1948-1955	Standard Cab			TSW1829T	WKT4266

See Page A417 for a Complete Listing of All Chevy/GMC Models.

CRL Chevy/GMC Side-Sliders for SUV's

- Replace Original Equipment Fixed Side Glass
- No Modifications Required for Installation

The CRL Side-Slider replaces original equipment fixed side glass in many older model sport utility vehicles. They fit the original gasket and opening, so no modifications are required for installation. These fully framed sliders have 31% dark gray tinted, D.O.T. approved glass surrounded by a black finish extruded aluminum frame. Sliding panels operate easily: Open for cooling ventilation; closed for security. Locking latches are included for safety. The Side-Slider's rugged construction will withstand rough off-road use, and full weatherstripping will prevent rattling while keeping drafts out of the interior. Sold only in pairs.

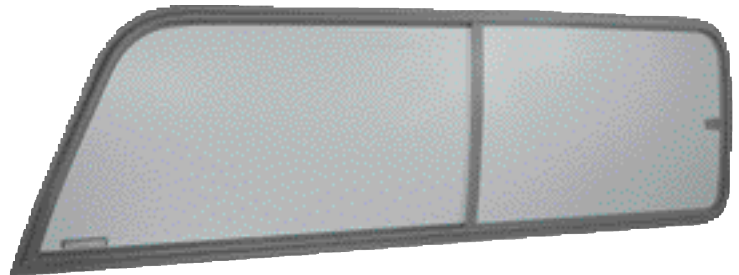

YEARS	MODEL	CAT. NO.
1973-1991	Chevy/GMC Suburban	MSS606
1973-1991	Chevy/GMC Blazer/Jimmy	MSS808



Chevy/GMC Truck Slider Application Guide

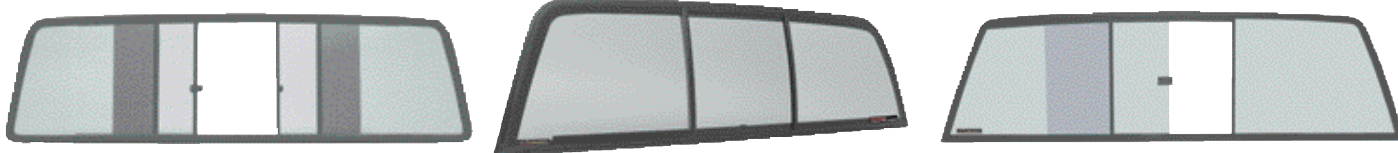
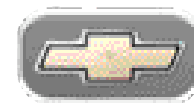

YEARS	MODEL	DIMENSIONS	FOUR PANEL CRL DUO-VENT				THREE PANEL CRL TRI-VENT				CRL		
			CLEAR	LIGHT TINT	DARK TINT	SOLAR	CLEAR	LIGHT TINT	DARK TINT	SOLAR	POWR-SLIDER	GASKET	
2004+	Colorado/Canyon	53-15/16" x 13-15/16"					ECT804B	ECT804LT		ECT804S	EPC804S		
2003+	Kodiak/Topkick	53" x 1/2" x 22"								ETRV877S	EPS877S		
1999+	Silverado/Sierra	64-3/4" x 18-1/8"					ECT899B	ECT899LT		ECT899S	EPC899S		
1994-2003	'S' Series	55-13/16" x 15-3/4"					ECT894B	ECT894LT		ECT894S	EPC894S		
1988-2000	'C/K'	64-1/8" x 18-1/2"	EDV880B	EDV880LT	EDV880BT	EDV880S				ETRV880BT	ETRV880S	EPS880	
1988-1992	'R/V'	62-3/4" x 14-1/2"	TSW850B	TSW850LT	TSW850BT							PS850	WBL1135
1982-1993	S-10/S-15	52-13/16" x 13-15/16"	TSW875B	TSW875LT	TSW875BT	TSW875S						PS875	WBL6425
1981-1983	Luv	46-3/4" x 12-1/4"	TSW575B	TSW575LT	TSW575BT								
1973-1987	'C/K'	62-3/4" x 14-1/2"	TSW850B	TSW850LT	TSW850BT							PS850	WBL1135
1973-1977	El Camino/Sprint	51-5/8" x 12-3/4"				TSW1824T							
1972-1980	Luv	46-1/8" x 13-1/16"	TSW550B	TSW550LT	TSW550BT								
1968-1972	El Camino/Sprint	55-1/4" x 14-11/16"				TSW1823T							
1967-1972	Standard Cab	58-7/8" x 13-15/16"	TSW100B	TSW100LT	TSW100BT							PS100	WBL1092
1967-1972	Small Window	41-1/8" x 11"	TSW1832										WBL1091
1960-1966	Custom Cab	60-1/2" x 14-3/4"	TSW1825										WKT6266
1960-1966	Small Window	36-7/8" x 9-7/8"	TSW1816										WKT4266
1955.5 -1959	Standard Cab	35" x 10-5/8"				TSW1835T							WKT4266
1948-1955	Standard Cab	31-1/8" x 10-3/8"				TSW1829T							WKT4266

Please Refer to Pages A434-A441 for a Complete Application Guide Listing All Makes and Models.

CRL Slider Application Charts

Our Slider Application Chart is the quick and easy way for your sales people to reference the correct CRL Slider for your customers. We show both CRL catalog numbers and NAGS® part numbers. Slider Application Charts are also available with your company logo imprinted on top. Contact CRL Customer Service for details.

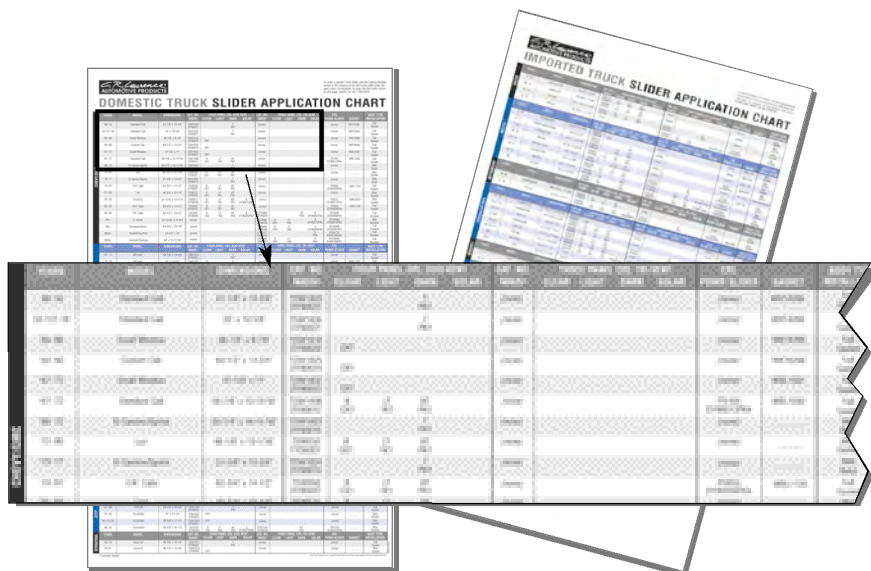

CAT. NO.	DESCRIPTION
AVD6244C	Application Chart
AVD6244L	Application Chart w/Your Logo



Gasket Installed Rear Glass

- Push Out Rear Glass and Gasket
- Clean Pinchweld Area Before Re-Installing Gasket
- Install Gasket Around Slider
- Insert 1/8" Nylon Rope in Gasket Channel
- Fit Slider Into Opening
- Pull Rope Ends to Lift Lip of Gasket Over Pinchweld



Push Out Rear Glass



Insert Rope

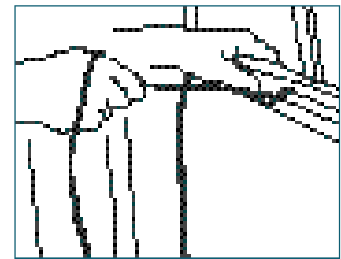

Fit Slider and Pull Rope



CAT. NO. RT752
Rope Insert Tool



CAT. NO. CP253
Hook Tool



CAT. NO. DV1K
Slider Installation Kit



CAT. NO. CRL216
Tapered Tip Stick Tool



CAT. NO. CRL220
Chisel Tipped Stick Tool

Bonded Rear Glass

- Remove Rear Glass Using Power Cut-Out Tool
- Trim Existing Urethane Bead
- Dry-Fit Slider to Check for Proper Fit
- Prep Cab and Prime Frame with Appropriate Urethane Primer
- Apply New Bead of Urethane
- Place Slider Into Opening, Then Bend Tabs or Install Clips



Cut Out Rear Glass

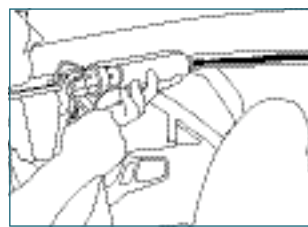

Apply Urethane

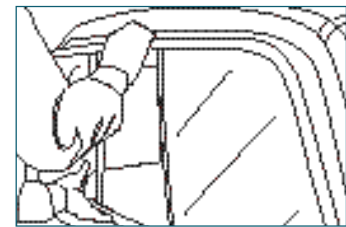

Secure Slider Into Opening



CAT. NO. AK70
Wildcat Knife Kit



CAT. NO. CG482N1
Cordless Caulking Gun

CAT. NO. CRL900HV
Urethane Adhesive



CAT. NO. BST1
Slider Buddy Installation Tool



SFC/CRL Sunroofs

- Factory Style Low Profile Frames
- Long Lasting Powder-Coat Finish
- High Performance Glass

No matter the year, model or size of Chevy/GMC truck, there is a SFC/CRL Sunroof to fit. Our sunroofs offer quality, a variety of sizes, and easy installation. From the traditional styling of the AutoPort, the contemporary styling of the NewPort, and all the way to Genesis, the most advanced pop-up sunroof in the industry, SFC/CRL offers an "open air" application for your vehicle.

If you're looking for the ultimate in sunroofs the CRL Electric Spoiler Sunroof is for you. It is available in two sizes: the 18" x 31" ES100 model for mid-size pickups, or the 20" x 32" ES300/500 for full-size trucks.

Overhead console in the way of a sunroof? Not when you use our His 'N Hers Sunroofs, which allow individual adjustment of airflow. A perfect example of how SFC/CRL Sunroofs have you covered.

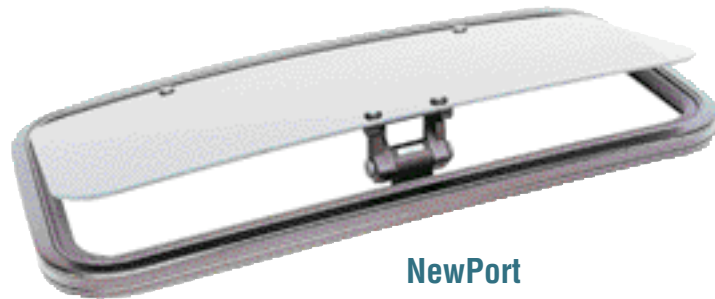

NewPort

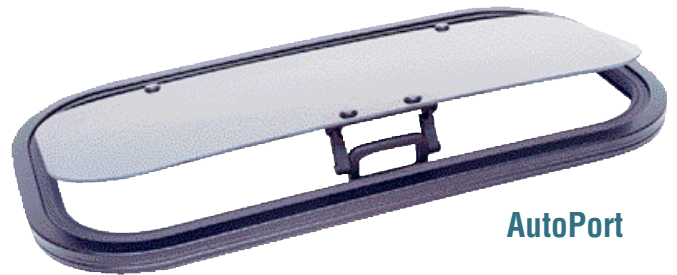

AutoPort



Genesis



His 'N Hers Sunroofs



See Pages **A450-A456** for a Complete Listing of All SFC/CRL Sunroofs.

Ram, Dakota, and D-50 Truck Sliders Back to '67



CRL offers over 35 years of Dodge truck sliders. Models include the original Duo-Vent four panel slider, the progressive three panel Tri-Vent, and our "top-of-the-line" electrically operated POWR-Slider rear sliding window.

Dodge has a history of making tough trucks. Trucks that have created a loyal following of Dodge owners that "drive'em til they drop", then fix them up and drive them some more.

We can make your Dodge truck more comfortable and stylish with a selection of sliders for every Dodge full size, mid-size, and mini truck. All are built to our tough standards for fit and finish, and are designed to replace the original backglass without modifications to the cab. For quality and style-conscious Dodge truck owners, CRL offers the best slider choices.

Dodge POWR-Slider

- Quick and Quiet Micro-Drive Motor
- Slim Line Three Panel Design
- Dark Tint or Solar Privacy Glass Maintains Cab Comfort
- Compound Curved Glass and "Perfect Fit" Frame on All Newer Model Years



Dodge Tri-Vent

- Original Equipment Three Panel Design Provides Largest Viewing Area
- "Perfect Fit" Flexible Flange Frame on Newer Models
- Dark Tint or Solar Privacy Glass Reduces Cab Heat Build-Up
- Exclusive Self-Locking Latch

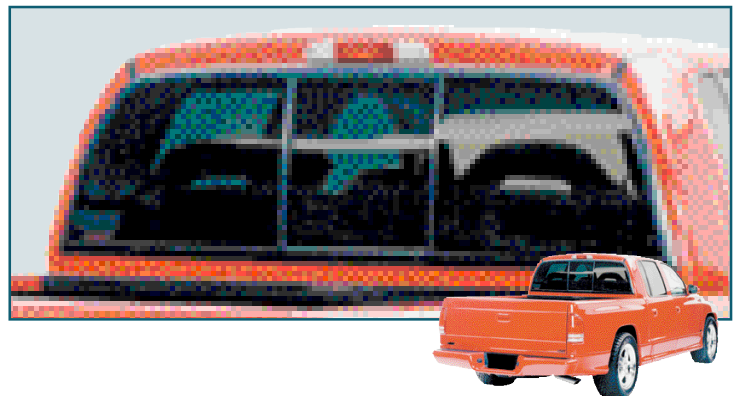

Dodge Duo-Vent

- Classic Four Panel Design Creates Largest Pass Through Opening
- Slim Line Frame for a Flush Fit
- Metal Locking Latches for Security
- Up to Four Glass Color Options on Some Models

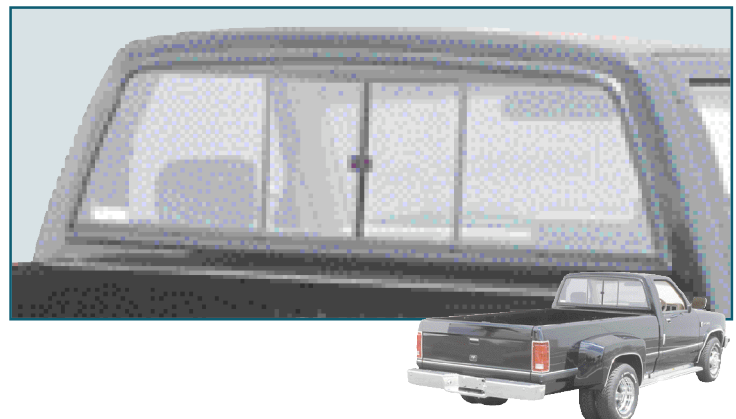

CRL Sliders for 2002 Dodge Ram 1500 and All 2003+ Dodge Rams

- Fully Contoured "Perfect Fit" Frame with Self-Centering Molding
- Solar Privacy Glass Opens and Closes Quietly
- Narrow Stiles and Tight-Sealing Weatherstrip

CRL "Perfect Fit" Tri-Vent Truck Sliders for the 2002+ Dodge Ram 1500 and all 2003+ Rams have the exclusive Channel Molding Edge that provides a customer-satisfied fit every time. The flexible soft rubber molding self-centers the slider in the body opening, conceals the weep holes, and helps to reduce road noise. Look for faster installations of CRL Sliders with our bend-over mounting tabs. They align the slider in the opening, and provide a quick securing system for bonded sliders.

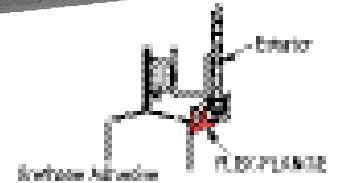
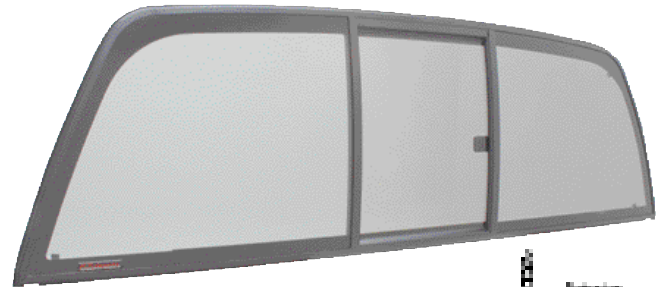

YEARS	MODEL	THREE PANEL CRL TRI-VENT			POWR-SLIDER
		CLEAR	LIGHT TINT	SOLAR	SOLAR
2003+	All Ram Cabs	ECT924B	ECT924LT	ECT924S	EPC924S
2002	Ram 1500 Only	ECT924B	ECT924LT	ECT924S	EPC924S

See Page **A424** for a Complete Listing of All Dodge Models.



CRL Sliders for 1994 - 2002 Dodge Ram (Except 2002 Ram 1500)

- Coated Aluminum Frame with Narrow Stiles and Tight-Sealing Weatherstrip
- "Perfect Fit" Frame with Flexible Flange

CRL's "Perfect Fit" Tri-Vent Truck Sliders have the exclusive Flexible Flange that provides a customer satisfied fit every time. The flexible soft rubber flange hugs the contours of the body, conceals the weep holes, and helps to reduce road noise. Look for faster installations of CRL Sliders with our bend-over mounting tabs. They align the slider in the opening, and provide a quick securing system for bonded sliders.

Please refer to our ECT924B, ECT924LT, and ECT924S Sliders above for 2002+ Dodge Ram 1500 Cabs, and our ECT944S Slider for 1995-1997 Dodge Ram Extended Cabs.

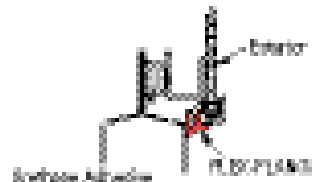
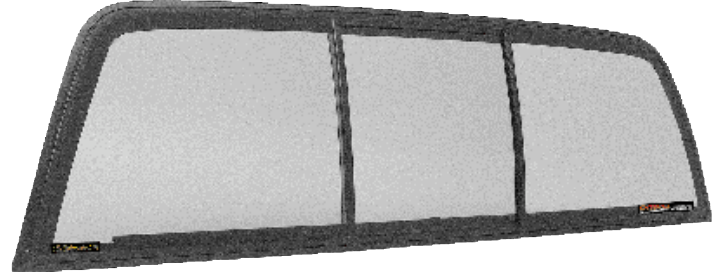

YEARS	MODEL	THREE PANEL CRL TRI-VENT	POWR-SLIDER
		SOLAR	SOLAR
1994 - 2002	All Ram Cabs Except '02 1500	ECT904S	EPC904S
1995 - 1997	Extended Cab	ECT944S	EPC944S

See Page **A424** for a Complete Listing of All Dodge Models.



CRL Sliders for 1997+ Dodge Dakota

- Fully Contoured "Perfect Fit" Frame with Flexible Flange
- Narrow Stiles and Tight-Sealing Weatherstrip

No truck manufacturer has done more to improve their pickups in the last few years than Dodge. The full-size Ram was completely redesigned in 1994, and the response by truck owners astounded the industry. Dodge followed up this success in 1997 with the restyled Dakota pickup, which became a hit with drivers who prefer a mid-sized truck. Clearly Dodge has the spirit of innovation.

C.R. Laurence has always been the leader in innovative truck accessories. First-to-the-industry successes such as POWR-Slider, the original full power rear sliding window, are testimony to the innovative spirit that drives C.R. Laurence to continually improve and expand our selection of accessories for Dodge trucks.

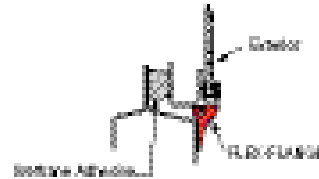
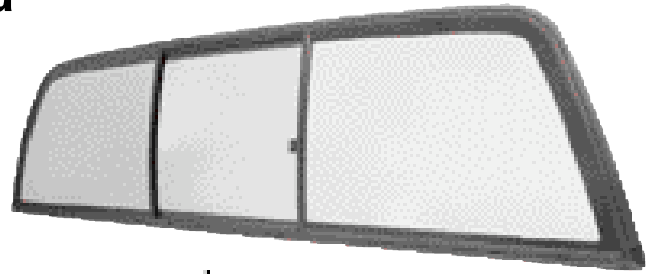

YEARS	MODEL	THREE PANEL CRL TRI-VENT			POWR-SLIDER SOLAR
		CLEAR	LIGHT TINT	SOLAR	
1997+	All Dakota Cabs	ECT410B	ECT410LT	ECT410S	EPC410S

See Page A424 for a Complete Listing of All Dodge Models.

CRL Sliders for 1986-1993 Dakota Standard Cab and 1986-1996 Dakota Extended Cab

CRL Truck Sliders for the Dodge Dakota includes the newest design features: state-of-the-art fully contoured, thin profile powder-coated aluminum frames; narrow stiles for maximum rear view; tight sealing weatherstrips to protect the interior. It is our attention to the details that make CRL Sliders stand out from any others. For better than factory quality style and function, insist on sliders manufactured by C.R. Laurence Co., Inc.

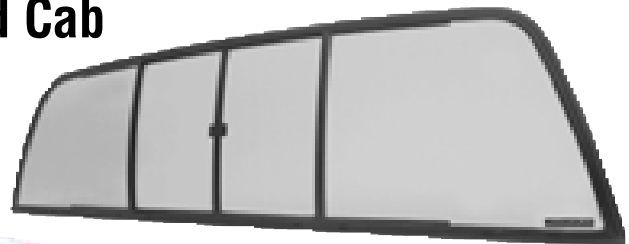

YEARS	MODEL	CLEAR	FOUR PANEL CRL DUO-VENT			THREE PANEL CRL TRI-VENT		POWR-SLIDER DARK TINT	GASKET
			LIGHT TINT	DARK TINT	SOLAR	DARK TINT	SOLAR		
1994-1996	Dakota Standard Cab (bonded glass)	EDV910B	EDV910LT	EDV910BT		ETRV910BT	ETRV910S	EPS910	
1986-1996	Dakota Extended Cab (bonded glass)						ETRV911S	EPS911	
1986-1993	Dakota Standard Cab (gasket set)	DVW910B	DVW910LT	DVW910BT	DVW910S	TRV910BT	TRV910S	PS910	WBL7158
1986-1996	Dakota Extended Cab (gasket set)	DVW910B	DVW910LT	DVW910BT	DVW910S	TRV910BT	TRV910S	PS910	WBL7158

See Page A424 for a Complete Listing of All Dodge Models.



CRL Sliders for 1975.5 - 1993 Dodge Ram

- Black Powder-Coated Narrow Stile Frame
- Self-Locking Latch on Tri-Vent
- One Touch Electric Operation on POWR-Slider



We make Four-Panel Duo-Vents and the Electric POWR-Slider for these classic Ram Pickups. Dodge built these trucks to last, and we make a slider that's just as durable. Black finish aluminum frames surround tempered glass in up to three color choices. They install with a rubber gasket, just like the factory glass, so you might want to check the existing gasket, because if it's old and cracked we have a replacement for that too.



YEARS	MODEL	FOUR PANEL CRL DUO-VENT			POWR-SLIDER	GASKET
		CLEAR	LIGHT TINT	DARK TINT	DARK TINT	
1975.5-1993	All Ram Cabs	TSW900B	TSW900LT	TSW900BT	PS900	WBL1129

See Page [A424](#) for a Complete Listing of All Dodge Models.

CRL Sliders for 1979 - 1996 Dodge D-50

- Fully Contoured Powder-Coated Aluminum Frame
- Narrow Stiles and Tight-Sealing Weatherstrip
- Some Models Available in Up to Four Glass Colors

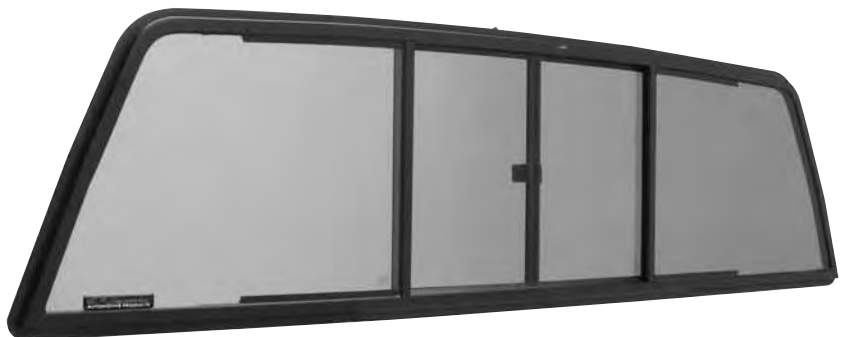

We offer CRL Sliders for the full range of Dodge D-50 trucks built from 1979 to 1996. All of the features that make CRL Sliders so popular can be found in our Four Panel Duo-Vents and Three Panel Tri-Vents designed exclusively for the D-50.

YEARS	MODEL	CLEAR	FOUR PANEL CRL DUO-VENT			THREE PANEL CRL TRI-VENT	GASKET
			LIGHT TINT	DARK TINT	SOLAR	DARK TINT	
1987-1996	D-50	DVW935B	DVW935LT	DVW935BT	DVW935S	TRV935BT	WBL3429
1979-1986	D-50	TSW925B	TSW925LT	TSW925BT			

See Page [A424](#) for a Complete Listing of All Dodge Models.

CRL Dodge Slider Application Guide

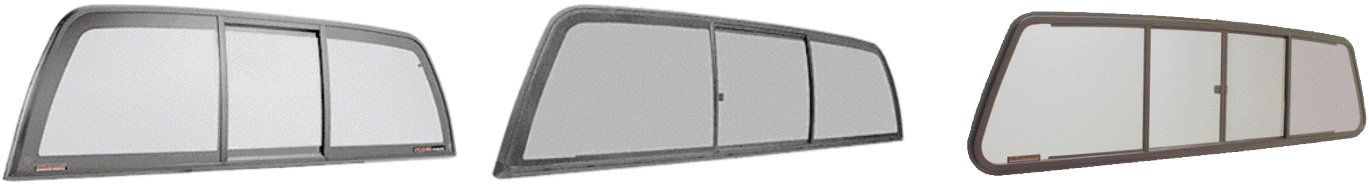

YEARS	MODEL	FOUR PANEL CRL DUO-VENT				THREE PANEL CRL TRI-VENT				CRL	
		CLEAR	LIGHT TINT	DARK TINT	SOLAR	CLEAR	LIGHT TINT	DARK TINT	SOLAR	POWR-SLIDER	GASKET
2003+	All Ram Cabs					ECT924B	ECT924LT		ECT924S	EPC924S	
2002	Ram 1500 Only					ECT924B	ECT924LT		ECT924S	EPC924S	
1997+	All Dakota Cabs					ECT410B	ECT410LT		ECT410S	EPC410S	
1994-2002	All Ram Cabs Except 2002 1500								ECT904S	EPC904S	
1995-1997	Ram Extended Cab								ECT944S	EPC944S	
1994-1996	Dakota Standard Cab	EDV910B	EDV910LT	EDV910BT				ETRV910BT	ETRV910S	EPS910	
1987-1996	D-50	DVW935B	DVW935LT	DVW935BT	DVW935S			TRV935BT			WBL3429
1986-1996	Dakota Extended Cab								ETRV911S	EPS911	
1986-1996	Dakota Extended Cab	DVW910B	DVW910LT	DVW910BT	DVW910S			TRV910BT	TRV910S	PS910	WBL7158
1986-1993	Dakota Standard Cab	DVW910B	DVW910LT	DVW910BT	DVW910S			TRV910BT	TRV910S	PS910	WBL7158
1979-1986	D-50	TSW925B	TSW925LT	TSW925BT							
1975.5-1993	All Ram Cabs	TSW900B	TSW900LT	TSW900BT						PS900	WBL1129
1972-1975	All Cabs			TSW1307T							WBL1129
1967-1971	All Cabs			TSW1814T							

Please refer to Pages **A434-A441** for a complete application guide listing all makes and models.

CRL Slider Application Charts

Our Slider Application Charts make it easy for you to quickly reference the correct slider to fit your customer's truck. Models for both domestic and imported trucks are listed, some as far back as 1948. We show both CRL catalog numbers and NAGS® part numbers. Charts are also available with your logo and address.

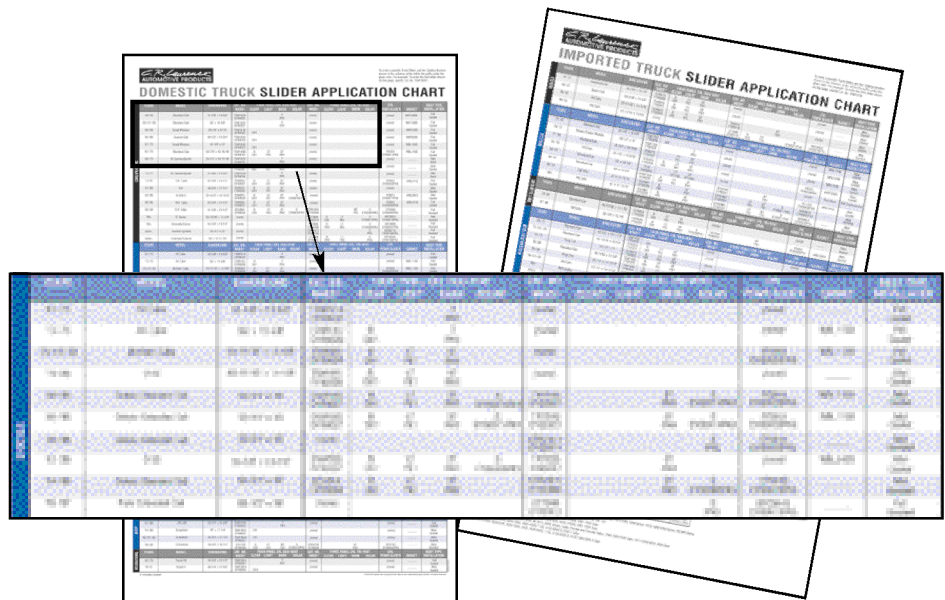

CAT. NO.	DESCRIPTION
AVD6244C	Application Chart
AVD6244L	Application Chart w/Logo



LOG ON TO crlaurence.com FOR BUSINESS-TO-BUSINESS SERVICES

A424 | PHONE (800) 421-6144 | FAX (800) 262-3299 TOLL FREE FROM ANYWHERE IN THE U.S.A. OR CANADA

Gasket Installed Rear Glass

- Push Out Rear Glass and Gasket
- Clean Pinchweld Area Before Re-Installing Gasket
- Install Gasket Around Slider
- Insert 1/8" Nylon Rope in Gasket Channel
- Fit Slider Into Opening
- Pull Rope Ends to Lift Lip of Gasket Over Pinchweld

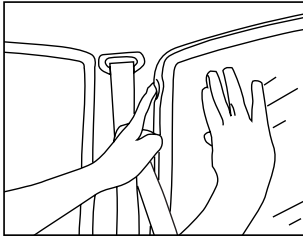

Push Out Rear Glass



CAT. NO. RT752
Rope Installation Tool



CAT. NO. CP253
Hook Tool

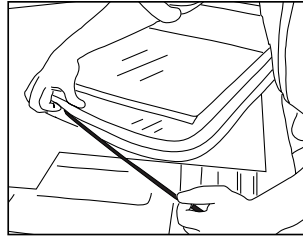

Insert Rope



CAT. NO. DV1K
Slider Installation Kit

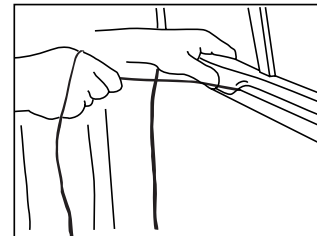

Fit Slider and Pull Rope



CAT. NO. CRL216
Tapered Tip Stick Tool



CAT. NO. CRL220
Chisel Tipped Stick Tool

Bonded Rear Glass

- Remove Rear Glass Using Power Cut-Out Tool
- Trim Existing Urethane Bead
- Dry-Fit Slider to Check for Proper Fit
- Prep Cab and Prime Frame with Appropriate Urethane Primer
- Apply New Bead of Urethane
- Place Slider Into Opening, Then Bend Tabs or Install Clips

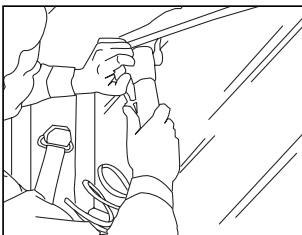

Cut Out Rear Glass



CAT. NO. AK60T00L

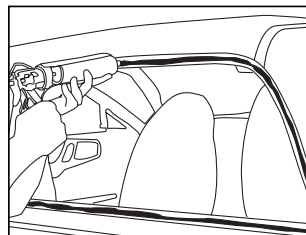

Apply Urethane

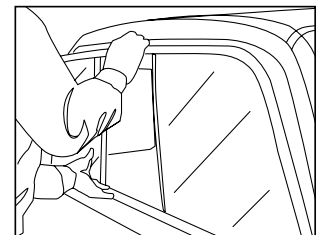

Secure Slider Into Opening



CAT. NO. RD924

- Uses All Oscillating Cut-Out Blades with Six or Twelve Sided Mounts

This CRL POWER-Cat Pneumatic Oscillating Cut-Out Knife has the power you need to remove auto glass. POWER-Cat is a heavy-duty pneumatic tool featuring a large, industrial grade air motor which delivers 20,000 oscillations per minute, plenty of power for your toughest cut-out needs. For details, see page A184.

- Oscillating Cut-Out Blade Lets You Remove Glass without Removing Headliner

This CRL Oscillating Cut-Out Blade for Wildcat, POWER-Cat or other oscillating cut-out knives has double machined edges to produce the thinnest and sharpest cuts possible. This blade allows the removal of the Dodge Ram rear sliding encapsulated window without removing the headliner, saving you lots of time on what is usually a complicated removal. For details, see page A186.

SFC/CRL Sunroofs

- Factory Style Low Profile Frames
- Long Lasting Powder-Coat Finish
- High Performance Glass

Dodge Pick-Up Trucks, from the "good old days" to current models, deserve the best quality sunroof. No matter the year, model or size of Dodge truck you have, there is always a CRL Sunroof that's just right for it. SFC/CRL Sunroofs offer quality in a variety of sizes, and ease of installation to add versatility to our product line. From the traditional styling of the AutoPort, the contemporary styling of the Newport, and all the way to Genesis, the most advanced pop-up sunroof in the industry, SFC/CRL offers an "open air" application for your vehicle.

If you're looking for the ultimate in sunroofs the CRL Electric Spoiler Sunroof is for you. It is available in two sizes: the 18" x 31" ES100 model for mid-size pick-ups, or the 20" x 32" ES300/500 for full-size trucks. Overhead console in the way of a sunroof? Not when you use our His 'N Hers Sunroofs, which allow individual adjustment of airflow. A perfect example of how SFC/CRL sunroofs have you covered.



See Pages **A450-A456** for a Complete Listing of All SFC/CRL Sunroofs.

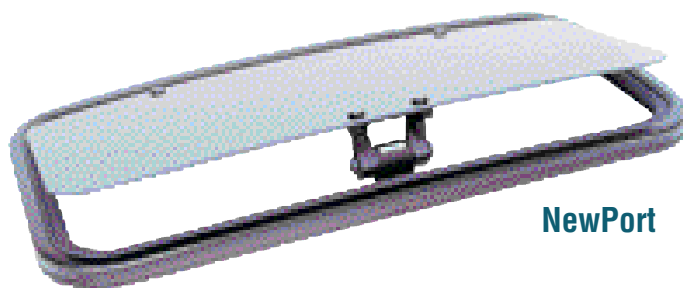

NewPort

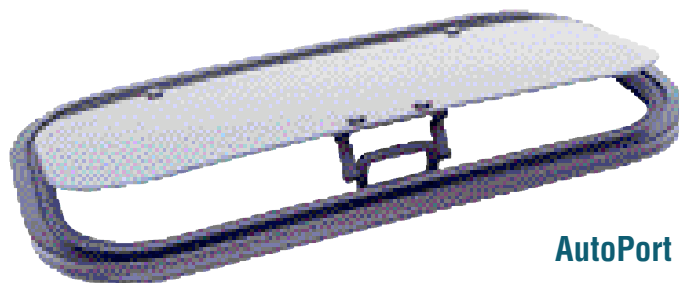

AutoPort

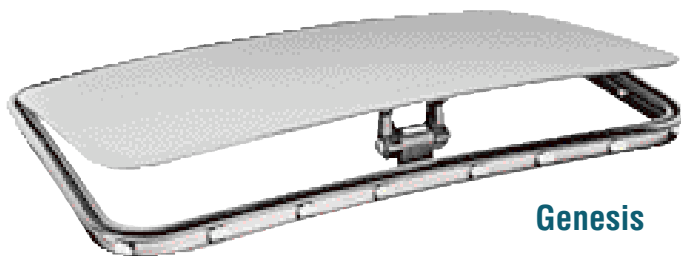

Genesis



His 'N Hers



CRL "Oldies" Sliders

- Available for Trucks Back to 1948
- Update Your Old Slider in Your Restored Vehicle
- Models Available with Clear, Dark Tint or Light Tint Glass

CRL offers the most extensive line of "Oldies" Sliders. These sliders offer you the quickest and easiest way to update that older model aluminum slider with a new powder-coated black-framed slider that your restored vehicle deserves. We cover all the popular trucks, some dating back to 1948. All are designed to fit the factory gasket and install without modification to the cab. Models with clear, light tint, and dark tint glass come standard with black finished frames. All have locking latches for security. Only CRL offers you a selection like this. See the Slider Application Chart on pages A434-A441 for a complete listing of "Oldies" Sliders. Catalog numbers for all "Oldies" Sliders begin with TSW.



CRL "Big Rig" Sliders

- Slider Convenience and Increased Cab Ventilation for Many Popular Big Rig Trucks
- Four Panel Frames with Clear Glass

With CRL Big Rig Sliders cab occupants enjoy a comfortable, flow through breeze. All Big Rig Sliders fit in the factory gasket without modification to the cab. Each slider has a traditional four panel black finish frame surrounding clear glass, and a locking latch for security.



MAKE	YEARS	MODEL	DIMENSIONS	CLEAR GLASS
GMC	1973-1980	Conv. Cab	38"x12"	BRW1831 DY90002CK1
GMC	1976-1988	Conv. Cab	48"x20"	BRW1845 DY90003CK1
Ford	1961-1990	Cab Over	58"x16"	BRW1838 DY90063CK1
Ford	1970-1998	Conv. Cab	52"x16"	BRW1850 DY90034CK1
Autocar	1967-1987	Conv. Cab	32"x16"	BRW1842 DY90001CK1
Brockway	1965-1971	Cab Over	50"x16"	BRW1844
Mack	1963-1971	CA47/CAS48		DY90058CK1
Mack Δ	1963+	Conv. Cab	44"x18"	BRW1843
		Cab Over		DY90057CK1
Freightliner#	1976+	FLC120	37"x21"	BRW1846 DY90047CK1
Freightliner C.O.E.	1979-1999	WFC120	26"x10"	BRW1847 DY90048CK1
Kenworth®	1965+	Short Window	28"x12"	BRW1840 DY90056CK1
Kenworth©	1965+	Tall Window	28"x17"	BRW1841 DY90055CK1
Navistar □ (International)	1971-2000	Conv. Cab	36"x20"	BRW1848 DY90059CK1
Navistar * (International)	1976-1978	Conv. Cab	49-1/2"x13-3/8"	BRW1849 DY90060CK1
Navistar ± (International)	1978-1993	Conv. Cab	50-1/4"x14-1/4"	BRW1851 DY90079CK1
Navistar	2001+	Conv. Cab	57-13/16"x18-5/8"	BRW1852@ DY90111PK4

NAGS Part Numbers are Copyright ©2002 National Auto Glass Specifications (NAGS) All Rights Reserved. Please refer to pages A434-A441 for a complete application guide listing all makes and models.



Δ 1963-1982 (CA47/CAS48/CA49 SERIES); 1965-1998 (CA49, DM,DMM,R,RB,RD,RL,RS,RW,U SERIES); 1975-1983 (CAW SERIES); 1979+ (MC/MR SERIES)
 # 1976-1987 (WFC 120); 1979+ (FLC 120, RAISED ROOF, SILVER AERO); 1993+ (CLASSIC XL, FLD 112, FLD 120)
 ® 1965+ (C500, C800, T450, T600, T800, W900); 1965-1999, (T400, K100, K100E)
 © 1965+ (C500, C800, T450, T600, T800, W900); 1965-1999, (T400, K100, K100E)
 □ 1971-1999 (4200,4300,5000,8500,9200, ALL 9370,9400, CONCO, EAGLE, PAYSTAR AND TRANSTAR CABS); 1989-2000 (9100 CABS); 1971-2000 (9200,9400 CABS)
 * 1976-1978 (1600-2100,2300-2600,3000,4600-4900,7100,8100-8300 S, 2200 S CABS)
 ± 1978-1993 (1600-2100,2300-2600,3000,4600-4900,7100,8100-8300 S); 1978-1989 (2200 S CABS)
 @ Encapsulated Installation

Duo-Vents, Tri-Vents and POWR-Sliders for New and Older Model Import Pickups

- Models as Far Back as 1967
- Slimline Frame and Vertical Stiles
- Install Just Like the Factory Glass
- Exclusive Self-Locking Latch on Tri-Vents
- Electric Operation on POWR-Slider

Import pickups have come a long way since they were first introduced to the American market, and CRL Sliders have kept up every step of the way. Our slimline main frame and narrow vertical stiles make for a smooth, sleek look. Enhanced weatherstrips and seals keep away wind, noise and water. Powder-coated finishing means long-lasting beauty. All Tri-Vents feature our exclusive Self-Locking Latch for convenient one-hand operation. The four-panel Duo-Vent gives you the largest possible opening. Our unique Micro-Drive Motor provides smooth and quiet electric operation for the POWR-Slider. Whichever model you choose, CRL provides the state-of-the-art in sliding rear windows for import pickups.

Duo-Vent

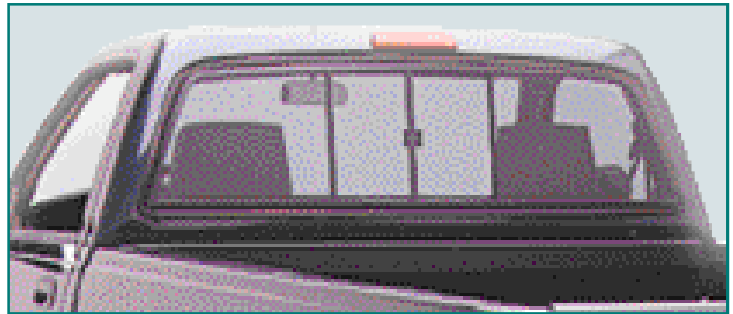

Tri-Vent

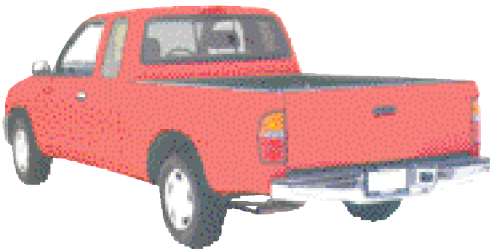

POWR-Slider



CRL Sliders for 1999+ Toyota Tundra

- Fully Contoured “Perfect Fit” Frame with Flexible Flange
- Solar Glass for Added Cab Comfort

Toyota Tundra owners should consider our Tri-Vents and POWR-Sliders as the number one option for their trucks. Easy to install and beautiful to look at, these sliders make all the difference in comfort and appearance. Our electric POWR-Slider provides the ultimate in convenience with touch-of-a-button control for added ventilation and wind noise reduction when the side windows are rolled down. All Tundra sliders feature our exclusive “Perfect Fit” frame with the Flexible Flange for a customer satisfied fit every time.

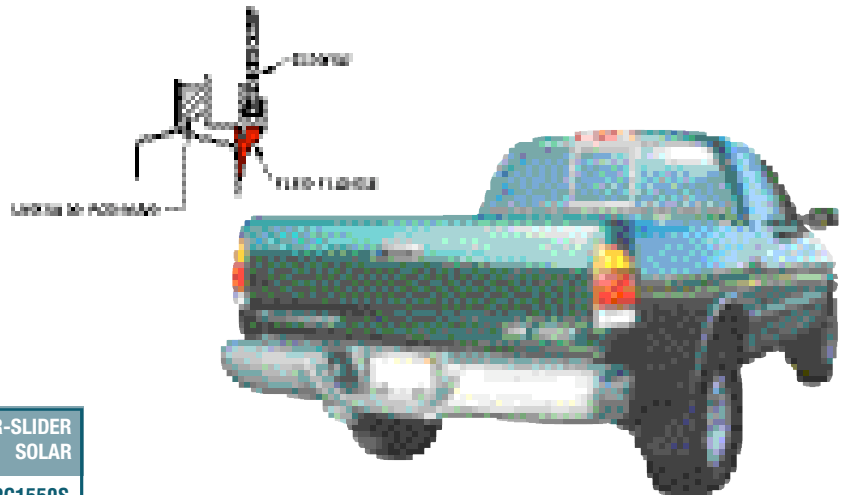
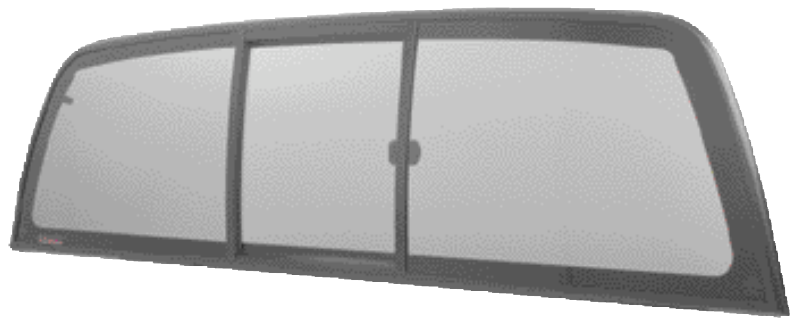

YEARS	MODEL	THREE PANEL CRL TRI-VENT SOLAR	POWR-SLIDER SOLAR
1999+	Tundra	ECT1550S	EPC1550S

See Pages **A432-A433** for a Complete Listing of All Import Models.

CRL Sliders for 1995-2004 Toyota Tacoma

- Powder-Coated Black Aluminum Frame Designed to Fit Like the OEM Back Glass
- Choice of Up to Four Glass Colors

This truck is so popular we built our complete range of sliders for it. Duo-Vent and Tri-Vent manual sliders, as well as the popular POWR-Slider all feature black powder-coated frames, narrow vertical stiles, and smooth operation with state-of-the-art weather tight seals. Our quiet, smooth operating POWR-Slider is the perfect choice for the extended cab owner because it provides easy access for quick ventilation.

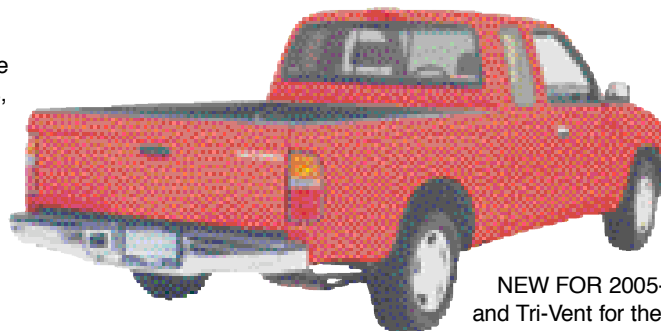
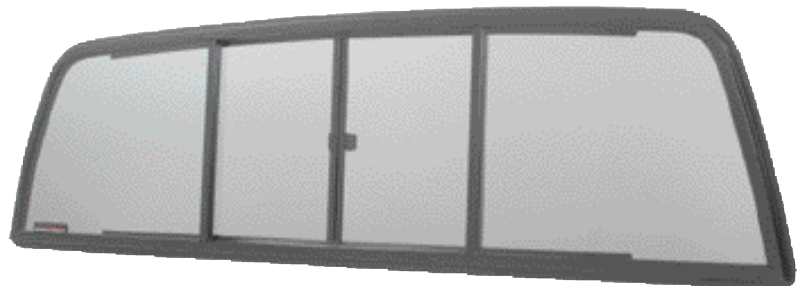

NEW FOR 2005-CRL POWR-Slider and Tri-Vent for the 2005+ Tacoma will be available in late 2004. See page A432 for model listing by manufacturer.

YEARS	MODEL	CLEAR	FOUR PANEL CRL DUO-VENT LIGHT TINT	DARK TINT	SOLAR	THREE PANEL CRL TRI-VENT DARK TINT	SOLAR	POWR-SLIDER SOLAR
1995-2004	Tacoma	DVW1500B	DVW1500LT	DVW1500BT	DVW1500S	TRV1500BT	TRV1500S	PS1500S

See Pages **A432-A433** for a Complete Listing of All Import Models.

CRL Sliders for 2004+ Nissan Titan

- Fully Contoured "Perfect Fit" Frame with Flexible Flange
- Narrow Stiles and Tight-Sealing Weatherstrip

The Titan is Nissan's first entry into the full size truck market, and we've got it covered with a CRL POWR-Slider and Tri-Vent Slider. As always, expect CRL's advanced slider features, such as our black powder-coated frame and narrow vertical stiles to give that wide open feeling, and dark solar glass to prevent heat buildup. Best of all, Titan Sliders all have our "Perfect Fit" Flexible Flange design for a customer satisfied fit, every time.

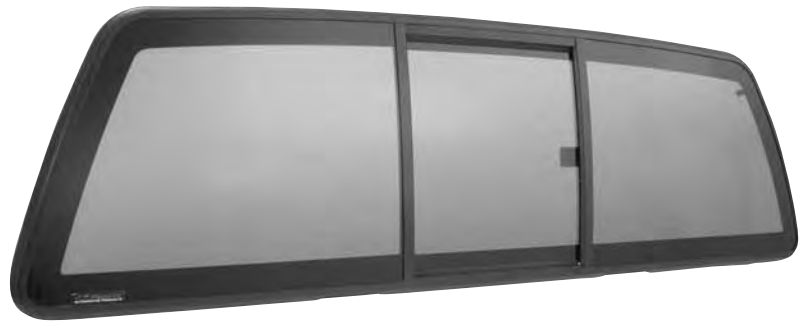
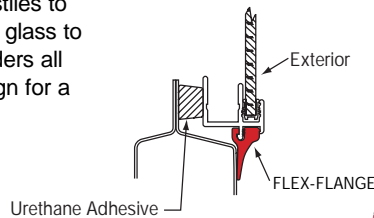

YEARS	MODEL	THREE PANEL CRL TRI-VENT SOLAR	POWR-SLIDER SOLAR
2004+	Titan	ECT664S	EPC664S

See Page **A432-A433** for a Complete Listing of All Import Models.

CRL Sliders for 1998-2004 Nissan Frontier

- Fully Contoured Powder-Coated Aluminum Frame with Narrow Stiles and Tight-Sealing Weatherstrip
- Quiet, Smooth Operating Glass Panel

CRL Sliders for the Nissan Frontier fit like a glove and provide the extra comfort level today's truck owners are looking for. The electrically operated POWR-Slider model gives drivers the added convenience of power. The dash-mounted switch allows you to open and close a slider on an extended cab truck without leaving the seat. The quiet, smooth operation makes it a pleasure to own. The manually operated Tri-Vent offers three glass colors, including solar gray to help keep the interior cooler.

NEW FOR 2005 - CRL POWR-Slider and Tri-Vent for the 2005+ Frontier will be available in late 2004. See page A432 for model listing by manufacturer.



YEARS	MODEL	THREE PANEL CRL TRI-VENT CLEAR	THREE PANEL CRL TRI-VENT LIGHT TINT	THREE PANEL CRL TRI-VENT SOLAR	POWR-SLIDER SOLAR
1998-2004	All Frontier	ETRV660B	ETRV660LT	ETRV660S	EPS660S

See Pages **A432-A433** for a Complete Listing of All Import Models.



CRL Sliders for 1998+ Mazda

- Fully Contoured Powder-Coated Aluminum Frame with Tempered Glass, Narrow Stiles, and Tight-Sealing Weatherstrip
- Also Fit All 1994-1997 Mazda Plus Cab Models

CRL Sliders for all 1998+ Mazda Standard and 1994 to 1997 Plus Cabs are the perfect choice whether you are replacing the back glass or a factory OEM slider. You just can't beat the features and quality of our manual Duo-Vent or Tri-Vent, or the electrically operated POWR-Slider. Built to last, our sliders provide styling and function for the life of the installation. Black powder-coated frames, tempered glass, and weather tight, smooth operating glass panels will provide you with a satisfied customer, every time.

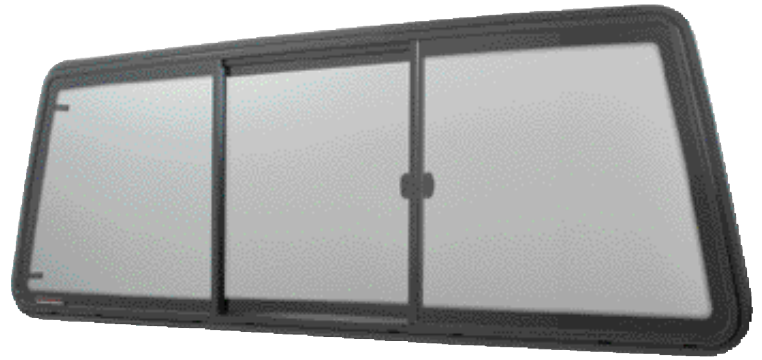

YEARS	MODEL	FOUR PANEL CRL DUO-VENT		THREE PANEL CRL TRI-VENT			POWR-SLIDER
		CLEAR	DARK TINT	LIGHT TINT	DARK TINT	SOLAR	SOLAR
1998+	All	EDV965B	EDV965BT	ETR965LT	ETR965BT	ETR965S	EPS965S

See Pages **A432-A433** for a Complete Listing of All Import Models.

CRL Sliders for 1996-2003 Isuzu

- Perfect Fit Flexible Flange for a Customer Satisfied Fit Every Time

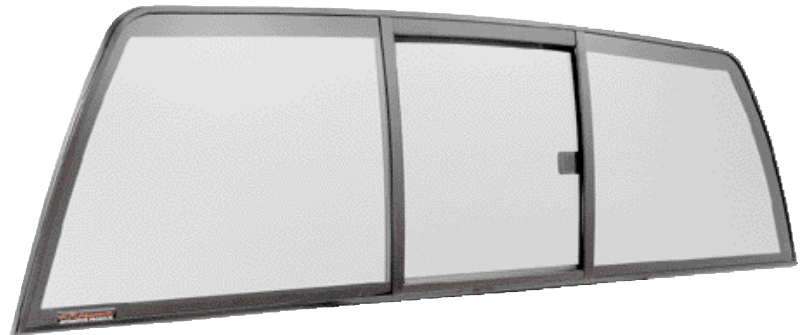
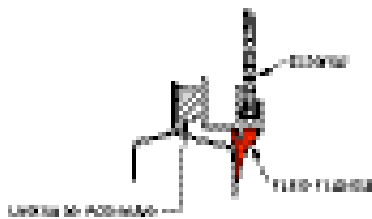

CRL builds two different sliders for Isuzu trucks, the manual three-panel Tri-Vent and electric POWR-Slider. We offer three glass colors in the Tri-Vent; Clear, Light Gray Tint, and Solar Tint. All POWR-Sliders come with Solar Tint glass. Black powder-coated frames provide a lifetime of protection. The tight weatherstrips and glass run channels provide easy operation and a quiet, smooth sliding panel. Whichever model you choose, you can be assured it's the right choice for your customer's Isuzu.



YEARS	MODEL	THREE PANEL CRL TRI-VENT			POWR-SLIDER
		CLEAR	LIGHT TINT	SOLAR	SOLAR
1996-2003	All	ECT894B	ECT894LT	ECT894S	EPC894S

See Pages **A432-A433** for a Complete Listing of All Import Models.

CRL POWR-Sliders

- Automatically Locks in Position with Release of the Switch
- Fast and Quiet Micro-Drive Motor
- Dark Tint or Solar Privacy Glass
- Slimline Black Frame

CRL Tri-Vents

- Original Equipment Three Panel Design
- Slimline Black Frame Provides Greatest Visibility
- All Models Available in Dark Tint or Solar Privacy Glass to Increase Cab Comfort

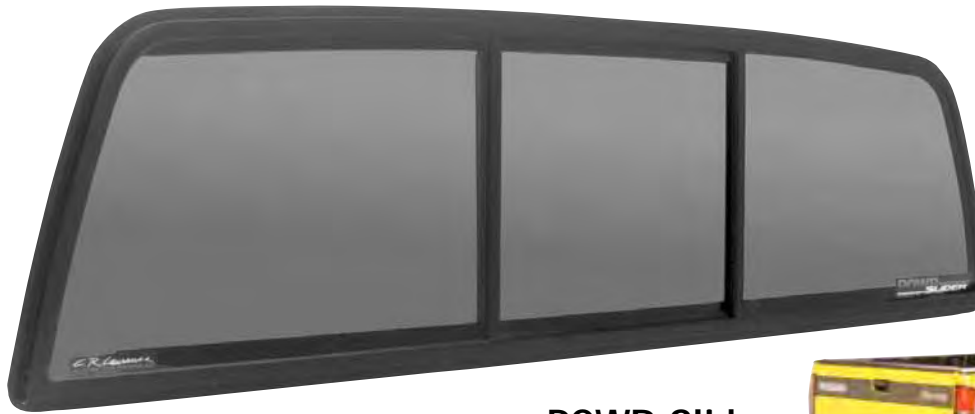

POWR-Slider



CRL offers sliders for seven import truck manufacturers. The CRL product line includes our progressive three panel Tri-Vent, traditional four panel Duo-Vent, and the exclusive POWR-Slider, the original electrically-powered rear truck slider. Each of our models are manufactured with strict quality standards, and designed to enhance the original factory styling.

BODY TYPE & INSTALLATION	YEARS	MODEL	DIMENSIONS (W x H)	CLEAR	THREE PANEL CRL TRI-VENT LIGHT TINT	THREE PANEL CRL TRI-VENT DARK TINT	SOLAR	CRL POWR-SLIDER
ISUZU								
Mid/Bonded	1996-2003	All Cabs	55-13/16" x 15-3/4"	ECT894B □	ECT894LT □		ECT894S □	EPC894S □
Mini/Gasket	1988-1995	All Cabs	52-11/16" x 14-3/16"			TRV610BT		
MAZDA								
Mid/Bonded	1998+	All Cabs	53" x 17-13/16"		ETRV965LT	ETRV965BT	ETRV965S	EPS965S
Mid/Bonded	1994-1997	Plus Cab	53" x 17-13/16"		ETRV965LT	ETRV965BT	ETRV965S	EPS965S
Mid/Gasket	1994-1997	Standard Cab	49" x 14-3/8"			TRV1200BT		PS1200
Mini/Gasket	1986-1993	All Cabs	50-1/8" x 14-9/16"					PS325
MITSUBISHI								
Mini/Gasket	1987-1996	All Cabs	53-1/8" x 13-7/8"			TRV935BT		
NISSAN/DATSUN								
Mini/Bonded	2005+	All Frontier	54-3/8" x 15-1/8"		ECT655LT		ECT655S	EPC655S
Full/Bonded	2004+	All Titan	63-11/16" x 17-11/16"		ECT664LT		ECT664S	EPC664S
Mini/Bonded	1998-2004	All Frontier	53-7/8" x 15-1/8"	ETRV660B	ETRV660LT		ETRV660S	EPS660S
Mini/Gasket	1986.5-1997	All Cabs	53-1/2" x 14-15/16"			TRV1060BT		PS1060
Mini/Gasket	1980-1986	Standard Cab	49-1/16" x 12-3/4"					PS1080
TOYOTA								
Mid/Bonded	2005+	All Tacoma	55-7/16" x 15"		ECT1510LT		ECT1510S	EPC1510S
Full/Bonded	1999+	All Tundra	60" x 16-1/2"				ECT1550S □	EPC1550S □
Mid/Gasket	1995-2004	All Tacoma	50-3/16" x 13-1/4"			TRV1500BT	TRV1500S	PS1500S
Mini/Gasket	1993-1998	All T100	58-3/8" x 14-7/8"			TRV500BT		PS500
Mini/Gasket	1989-1995	SR5 Xtra	50-1/2" x 14-7/8"			TRV1460BT		PS1460
Mini/Gasket	1984-1995	SR5 Standard	50-3/16" x 13-3/16"			TRV1400BT		PS1400
Mini/Gasket	1984-1988	SR5 Extended	51-1/4" x 15-13/16"					PS1425

Please Refer to Pages **A434-A441** for a Complete Application Guide Listing All Makes and Models.

□ *Perfect Fit* Flexible Flange Frame



LOG ON TO crlaurence.com FOR BUSINESS-TO-BUSINESS SERVICES

A432 | PHONE (800) 421-6144 | FAX (800) 262-3299 TOLL FREE FROM ANYWHERE IN THE U.S.A. OR CANADA

CRL Duo-Vents

- Classic Four Panel Design
- Up to Four Glass Options
- Largest Pass Through Opening
- Metal Locking Latches for Security
- Full Perimeter Black Frame



It's hard to believe that import pickups have been on American roads for almost 40 years, but over that time a number of foreign automobile companies have shipped in their mini, mid, and now full size pickups. Very early on CRL recognized how big this market would eventually become, and since then have been producing rear sliders to fit virtually every import pickup you can name. All CRL Sliders are produced with the same attention to detail that makes us the premier slider manufacturer. Our variety of selection assures you that if you have a customer looking for a slider for their import truck, you'll be able to fill their needs.

BODY TYPE & INSTALLATION	YEARS	MODEL	DIMENSIONS (W X H)	FOUR PANEL CRL DUO-VENT				GASKET
				CLEAR	LIGHT TINT	DARK TINT	SOLAR	
ISUZU								
Mini/Gasket	1988-1995	All Cabs	52-11/16" x 14-3/16"	TSW610B	TSW610LT	TSW610BT		
Mini/Gasket	1986-1987	Space Cab	49-3/16" x 15-5/8"	TSW600B	TSW600LT	TSW600BT		
Mini/Gasket	1981-1987	Standard Cab	46-3/4" x 12-1/4"	TSW575B	TSW575LT	TSW575BT		
MAZDA								
Mid/Bonded	1998+	All Cabs	53" x 17-13/16"	EDV965B		EDV965BT		
Mid/Bonded	1994-1997	Plus Cab	53" x 17-13/16"	EDV965B		EDV965BT		
Mid/Gasket	1994-1997	Standard Cab	49" x 14-3/8"	DVW1200B	DVW1200LT	DVW1200BT		WBL1163
OEM	1994-1997	All Cabs	49" x 14-3/8"		7140ET	7140EP		Provided
Replacement								
Mini/Gasket	1986-1993	All Cabs	50-1/8" x 14-9/16"	TSW325B	TSW325LT	TSW325BT		WCR3098
Mini/Gasket	1977-1985	Standard Cab	48-3/4" x 13-1/16"		TSW375LT	TSW375BT		WBL1148
Mini/Gasket	1974-1977	Rotary Only	46-1/2" x 13"			TSW1319T		WBL1148
Mini/Gasket	1972-1976	Standard Cab	45-1/8" x 12-5/8"	TSW1810				WBL1148
MITSUBISHI								
Mini/Gasket	1987-1996	Std. and Macro Cabs	53-1/8" x 13-7/8"	DVW935B	DVW935LT	DVW935BT	DVW935S	WBL3429
Mini/Gasket	1979-1986	Standard Cab	46-11/16" x 14-1/16"	TSW925B	TSW925LT	TSW925BT		
NISSAN/DATSUN								
Mini/Gasket	1986.5-1997	All Cabs	53-1/2" x 14-15/16"	DVW1060B	DVW1060LT	DVW1060BT	DVW1060S	WBL3230
Mini/Gasket	1980-1986	King Cab	52-1/8" x 14-15/16"	TSW1090B	TSW1090LT	TSW1090BT		WBL1989
Mini/Gasket	1980-1986	Standard Cab	49-1/16" x 12-3/4"	TSW1080B	TSW1080LT	TSW1080BT		WBL1988
Mini/Gasket	1976-1979	King Cab	48-1/8" x 13"	TSW675B	TSW675LT	TSW675BT		WBL1149
Mini/Gasket	1972.5-1979	Standard Cab	45-13/16" x 10-1/8"	TSW350B	TSW350LT	TSW350BT		WBL1142
Mini/Gasket	1967-1972	Standard Cab	42-5/8" x 10-11/16"	TSW1400				
SUBARU								
Mini/Gasket	1982-1991	Brat	46" x 13"	TSW1375B				
Mini/Gasket	1978-1981	Brat	43-1/2" x 13-1/2"	TSW1975	TSW1975T			
TOYOTA								
Mini/Gasket	1995-2004	All Tacoma	50-3/16" x 13-1/4"	DVW1500B	DVW1500LT	DVW1500BT	DVW1500S	WBLF5475
Mid/Gasket	1993-1998	All T100	58-3/8" x 14-7/8"	DVW500B	DVW500LT	DVW500BT		WBL4798
Mini/Gasket	1989-1995	SR5 Xtra	50-1/2" x 14-7/8"	TSW1460B	TSW1460LT	TSW1460BT		WBL3894
Mini/Gasket	1984-1995	SR5 Standard	50-3/16" x 13-3/16"	TSW1400B	TSW1400LT	TSW1400BT	TSW1400S	WBL2669 '84-'88 WBL2669A '89-'95
Mini/Gasket	1984-1988	SR5 Extended	51-1/4" x 15-13/16"	TSW1425B	TSW1425LT	TSW1425BT		WBL2674
Mini/Gasket	1979-1983	Standard Cab	45-3/8" x 11-1/2"	TSW1025B	TSW1025LT	TSW1025BT		WBL3971
Mini/Gasket	1973-1978	Standard Cab	44-13/16" x 12-1/16"	TSW1050B	TSW1050LT	TSW1050BT		WBL1143
Mini/Gasket	1969-1972	Standard Cab	46-1/2" x 12-1/8"			TSW1819T		
VOLKSWAGEN								
Mini/Gasket	1980-1983	Rabbit	45" x 14"	TSW1070B	TSW1070LT			

Please Refer to Pages A434-A441 for a Complete Application Guide Listing All Makes and Models.



CRL TRUCK SLIDER APPLICATION CHART

For Pricing on CRL Products, Call Toll Free (800) 421-6144, or Visit crlaurence.com



CAT. NO. DVW950S

FORD

YEARS	MODEL	DIMENSIONS	CLEAR	FOUR PANEL CRL DUO-VENT			GASKET
				LIGHT TINT	DARK TINT	SOLAR	
1999+	Ranger Quad	53" x 17-13/16"	EDV965B DY90039CK2		EDV965BT DY90039PK2		
1998+	All Ranger	53" x 17-13/16"	EDV965B DY90039CK2		EDV965BT DY90039PK2		
1997-1998	F-250/F-350 2 Door, Super and 4 Door Crew Cabs	59-3/8" x 17"	DVW950B DY90035CK1	DVW950LT DY90035YK1	DVW950BT DY90035PK1	DVW950S DY90065PK1	WBL1158
1986-1997	Ranger Super	53" x 17-13/16"	EDV965B DY90039CK2		EDV965BT DY90039PK2		
1983-1997	Ranger Standard	49" x 14-3/8"	DVW1200B DY90037CK1	DVW1200LT DY90037YK1	DVW1200BT DY90037PK1		WBL1163
1983-1997	Ranger Standard	49" x 14-3/8"		7140ETA DB08400GT1CRL	7140EP DB08400YP1CRL		Provided
1977-1982	Courier	48-3/4" x 13-1/16"		TSW375LT FY95002YK1	TSW375BT FY95002PK1		WBL1148
1976.5-1977	Courier	46-1/2" x 13"			TSW1319T FY95003PK1		
1973-1996	F-Series	59-3/8" x 17"	DVW950B DY90035CK1	DVW950LT DY90035YK1	DVW950BT DY90035PK1	DVW950S DY90065PK1	WBL1158
1973-1996	F-Series	59-3/8" x 17"		7130ETA DB08399GT1CRL	7130EP DB08399YP1CRL		Provided
1972-1979	Ranchero	54-7/8" x 12-11/16"			TSW1750T DY90041PK1		
1972-1976	Courier	45-1/8" x 12-5/8"	TSW1810 FY95004CK1				
1967-1972	All	55-5/16" x 13-3/16"	TSW200B DY90042CK1	TSW200LT DY90042YK1	TSW200BT DY90042PK1		WBL1089
1961-1966	All	49-13/16" x 13-11/16"	TSW1450 DY90044CK1				WBL1052
1957-1960	All	44-3/4" x 11"	TSW1827 DY90045CK1		TSW1827T DY90045PK1		WBL1015
1953-1956	All	50-1/4" x 11"			TSW1826T DY90046PK1		WBL1103

△ OEM Style Replacement Slider. NAGS Part Numbers are Copyright©2002 National Auto Glass Specifications (NAGS). All Rights Reserved.



LOG ON TO crlaurence.com FOR BUSINESS-TO-BUSINESS SERVICES

A434 | PHONE (800) 421-6144 | FAX (800) 262-3299 TOLL FREE FROM ANYWHERE IN THE U.S.A. OR CANADA

CRL TRUCK SLIDER APPLICATION CHART

For Pricing on CRL Products, Call Toll Free (800) 421-6144, or Visit crlaurence.com



CAT. NO. PSC998S

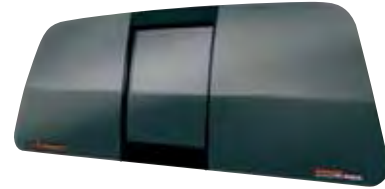

CAT. NO. EPC990S

FORD/LINCOLN

YEARS	MODEL	DIMENSIONS	CLEAR	THREE PANEL CRL TRI-VENT LIGHT TINT	DARK TINT	SOLAR	CRL POWR-SLIDER	GASKET
2004+	New F-150	63-1/2" x 16-7/8"		ECT994LT DY90109YK5		ECT994S DY90109PK5	EPC994S DY90110PK5	
2004+	F-150 Heritage	58-7/8" x 18-1/4"	ECT990B DY90086CK4	ECT990LT DY90086YK4		ECT990S DY90086PK4	EPC990S DY90093PK4	
2002-2003	Lincoln Blackwood	58-7/8" x 18-1/4"	ECT990B DY90086CK4	ECT990LT DY90086YK4		ECT990S DY90086PK4	EPC990S DY90093PK4	
2000+	F-250/F-650/F-750 4 Door Crew	64-5/8" x 18-1/2"				TRC998S DY90084PK4	PSC998S DY90085PK4	WBL450
1999+	F-Series 250 Heavy-Duty, 350 4 Door Crew Cabs	64-5/8" x 18-1/2"				TRC998S DY90084PK4	PSC998S DY90085PK4	WBL450
1999+	Ranger Quad	53" x 17-13/16"		ETRV965LT DY90039YK5	ETRV965BT DY90039PK5	ETRV965S DY90071PK5	EPS965SQ DY90098PK5	
1998+	All Ranger	53" x 17-13/16"		ETRV965LT DY90039YK5	ETRV965BT DY90039PK5	ETRV965S DY90071PK5	EPS965S DY90040PK5	
1997-1998	F-250/F-350 2 Door, Super and 4 Door Crew Cabs	59-3/8" x 17"			TRV950BT DY90035PK4	TRV950S DY90065PK4	PS950 DY90036PK4	WBL1158
1997-2003	F-150/F-250 Light Duty All Trucks	58-7/8" x 18-1/4"	ECT990B DY90086CK4	ECT990LT DY90086YK4		ECT990S DY90086PK4	EPC990S DY90093PK4	
1986-1997	Ranger Super	53" x 17-13/16"		ETRV965LT DY90039YK5	ETRV965BT DY90039PK5	ETRV965S DY90071PK5	EPS965S DY90040PK5	
1983-1997	Ranger Standard	49" x 14-3/8"			TRV1200BT DY90037PK4		PS1200 DY90038PK4	WBL1163
1973-1996	F-Series	59-3/8" x 17"			TRV950BT DY90035PK4	TRV950S DY90065PK4	PS950 DY90036PK4	WBL1158

NAGS Part Numbers are Copyright©2002 National Auto Glass Specifications (NAGS). All Rights Reserved.

Log On to crlaurence.com for the Easy Way to Select the Right CRL Rear Slider for Any Truck

The CRL Web Site has a simple to use feature that makes it easy for you to select the correct CRL Rear Slider for any truck. Simply click on the year, make, and model of the truck and we'll display your choices. What could be easier?

C.R. LAURENCE COMPANY INC.
AN ISO9000 COMPANY
Supplying the World with Glazing, Industrial, Construction, Architectural and Automotive Supplies

Product Search Here [Go] [Help]

Log in Home Contact Us Bulletin Board Documents Product of the Month View Cart and Checkout

Auto Glass and Accessories Glass Hardware and Accessories Sealants, Tools and Accessories New Product Section

Truck Slider Search

Ever Improving Quality and Features Make C.R. Laurence Today's Choice for High Quality Automotive Windows

CRL offers Sliders for almost any truck, some going back to 1948. You can quickly find the right Truck Slider by either entering your vehicle year, then make and model by moving your mouse (pointer) over each drop down menu and clicking, or by entering the NAGS Number.

When the results are displayed, read the description of the Slider you wish to view and click on the link. You will then go to a page where you can read about the Slider and make your purchase. (Businesses Only)

Search By Year, Make, and Model

Select the Year [v] Select the Make [v] Select the Model [v]

or Search By NAGS Number

[Go]

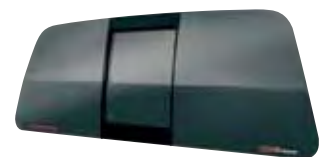

At crlaurence.com You're Just Three Clicks Away from Finding the CRL Rear Slider You Need for Any Truck!

LOG ON TO crlaurence.com FOR BUSINESS-TO-BUSINESS SERVICES

PHONE (800) 421-6144 | FAX (800) 262-3299 TOLL FREE FROM ANYWHERE IN THE U.S.A. OR CANADA | A435



CRL TRUCK SLIDER APPLICATION CHART

For Pricing on CRL Products, Call Toll Free (800) 421-6144, or Visit crlaurence.com



CAT. NO. EPC894S



CAT. NO. EDV880BT



CAT. NO. ECT899S



CHEVY/GMC

YEARS	MODEL	DIMENSIONS	FOUR PANEL CRL DUO-VENT				CRL		GASKET
			CLEAR	LIGHT TINT	DARK TINT	SOLAR	POWR-SLIDER		
1988-2000	'C/K' Cabs	64-1/8" x 18-1/2"	EDV880B DY90004CK2	EDV880LT DY90004YK2	EDV880BT DY90004PK2	EDV880S DY90005PK2	EPS880 DY90006PK5		
1988-1992	'R/V' Cabs	62-3/4" x 14-1/2"	TSW850B DY90007CK1	TSW850LT DY90007YK1	TSW850BT DY90007PK1		PS850 DY90008PK4	WBL1135	
1982-1993	S-10/S-15	52-13/16" x 13-15/16"	TSW875B DY90009CK1	TSW875LT DY90009YK1	TSW875BT DY90009PK1	TSW875S DY90010PK1	PS875 DY90011PK4	WBL6425	
1981-1983	Luv	46-3/4" x 12-1/4"	TSW575B FY95000CK1	TSW575LT FY95000YK1	TSW575BT FY95000PK1				
1973-1987	'C/K' Cabs	62-3/4" x 14-1/2"	TSW850B DY90007CK1	TSW850LT DY90007YK1	TSW850BT DY90007PK1		PS850 DY90008PK4	WBL1135	
1973-1977	El Camino/Sprint	51-5/8" x 12-3/4"			TSW1824T DY90014PK1				
1972-1980	Luv	46-1/8" x 13-1/16"	TSW550B FY95001CK1	TSW550LT FY95001YK1	TSW550BT FY95001PK1				
1968-1972	El Camino/Sprint	55-1/4" x 14-11/16"			TSW1823T DY90015PK1				
1967-1972	Standard Cab	58-7/8" x 13-15/16"	TSW100B DY90012CK1	TSW100LT DY90012YK1	TSW100BT DY90012PK1		PS100 DY90013PK4	WBL1092	
1967-1972	Small Window	41-1/8" x 11"	TSW1832 DY90023CK1					WBL1091	
1960-1966	Custom Cab	60-1/2" x 14-3/4"	TSW1825 DY90019CK1					WKT6266	
1960-1966	Small Window	36-7/8" x 9-7/8"	TSW1816 DY90020CK1					WKT4266	
1955.5-1959	Standard Cab	35" x 10-5/8"			TSW1835T DY90021PK1			WKT4266	
1948-1955	Standard Cab	31-1/8" x 10-3/8"			TSW1829T DY90022PK1			WKT4266	

YEARS	MODEL	DIMENSIONS	THREE PANEL CRL TRI-VENT			CRL		GASKET
			CLEAR	LIGHT TINT	DARK TINT	SOLAR	POWR-SLIDER	
2004+	Colorado/Canyon	53-15/16" x 13-15/16"	ECT804B DY90107CK5	ECT804LT DY90107YK5		ECT804S DY90107PK5	EPC804S DY90108PK5	
2003+	Kodiak/TopKick	53-1/2" x 22"				ETRV877S DY90105PK5	EPS877S DY90106PK5	
1999+	Silverado/Sierra	64-3/4" x 18-1/8"	ECT899B DY90096CK5	ECT899LT DY90096YK5		ECT899S DY90095PK5	EPC889S DY90097PK5	
1994-2003	S-Series	55-13/16" x 15-3/4"	ECT894B DY90076CK5	ECT894LT DY90076YK5		ECT894S DY90075PK5	EPC894S DY90018PK5	
1988-2000	'C/K' Cabs	64-1/8" x 18-1/2"			ETRV880BT DY90004PK5	ETRV880S DY90005PK5	EPS880 DY90006PK5	

NAGS Part Numbers are Copyright©2002 National Auto Glass Specifications (NAGS). All Rights Reserved.



LOG ON TO crlaurence.com FOR BUSINESS-TO-BUSINESS SERVICES

A436 | PHONE (800) 421-6144 | FAX (800) 262-3299 TOLL FREE FROM ANYWHERE IN THE U.S.A. OR CANADA

CRL TRUCK SLIDER APPLICATION CHART

For Pricing on CRL Products, Call Toll Free (800) 421-6144, or Visit crlaurence.com



CAT. NO. ECT904S



CAT. NO. ECT410S



CAT. NO. EPC924S



DODGE

YEARS	MODEL	DIMENSIONS	CLEAR	FOUR PANEL CRL DUO-VENT			SOLAR	CRL POWR-SLIDER	GASKET
				LIGHT TINT	DARK TINT				
1994-1996	Dakota Standard Cab	55-3/4" x 16"	EDV910B DY90064CK2	EDV910LT DY90064YK2	EDV910BT DY90064PK2		EPS910 DY90029PK5		
1987-1996	D-50	53-1/8" x 13-7/8"	DVW935B FY95007CK1	DVW935LT FY95007YK1	DVW935BT FY95007PK1	DVW935S FY95008PK1		WBL3429	
1986-1996	Dakota Extended Cab	55-3/4" x 16"	DVW910B DY90027CK1	DVW910LT DY90027YK1	DVW910BT DY90027PK1	DVW910S DY90074PK1	PS910 DY90028PK4	WBL7158	
1986-1993	Dakota Standard Cab	55-3/4" x 16"	DVW910B DY90027CK1	DVW910LT DY90027YK1	DVW910BT DY90027PK1	DVW910S DY90074PK1	PS910 DY90028PK4	WBL7158	
1979-1986	D-50	46-11/16" x 14-1/8"	TSW925B FY95009CK1	TSW925LT FY95009YK1	TSW925BT FY95009PK1				
1975.5-1993	All Ram Cabs	55-11/16" x 14-3/8"	TSW900B DY90024CK1	TSW900LT DY90024YK1	TSW900BT DY90024PK1		PS900 DY90025PK4	WBL1129	
1972-1975	All Cabs	55" x 13-5/8"			TSW1307T DY90026PK1			WBL1129	
1967-1971	All Cabs	58-1/8" x 13-5/8"			TSW1814T DY90032PK1				

YEARS	MODEL	DIMENSIONS	CLEAR	THREE PANEL CRL TRI-VENT			SOLAR	CRL POWR-SLIDER	GASKET
				LIGHT TINT	DARK TINT				
2003+	All Ram Cabs	65-1/2" x 19-3/8"	ECT924B DY90102CK4	ECT924LT DY90102YK4		ECT924S DY90103PK4	EPC924S DY90104PK4		
2002	Ram 1500 Only	65-1/2" x 19-3/8"	ECT924B DY90102CK4	ECT924LT DY90102YK4		ECT924S DY90103PK4	EPC924S DY90104PK4		
1997+	All Dakota Cabs	56-11/16" x 16-9/16"	ECT410B DY90082CK5	ECT410LT DY90082YK5		ECT410S DY90088PK5	EPC410S DY90083PK5		
1995-1997	Ram Extended Cab	65-1/2" x 18"				ECT944S DY90072PK5	EPC944S DY90073PK5		
1994-2002	All Ram Cabs Except '02 1500	65-1/2" x 18"				ECT904S DY90000PK5	EPC904S DY90031PK5		
1994-1996	Dakota Standard Cab	55-3/4" x 16"			ETRV910BT DY90064PK5	ETRV910S DY90066PK5	EPS910 DY90029PK5		
1987-1996	D-50	53-1/8" x 13-7/8"			TRV935BT FY95007PK4			WBL3429	
1986-1996	Dakota Extended Cab	55-3/4" x 16"				ETRV911S DY90074PK5	EPS911 DY90028PK5		
1986-1996	Dakota Extended Cab	55-3/4" x 16"			TRV910BT DY90027PK4	TRV910S DY90074PK4	PS910 DY90028PK4	WBL7158	
1986-1993	Dakota Standard Cab	55-3/4" x 16"			TRV910BT DY90027PK4	TRV910S DY90074PK4	PS910 DY90028PK4	WBL7158	

NAGS Part Numbers are Copyright © 2002 National Auto Glass Specifications (NAGS). All Rights Reserved.

The Easy Way to Select the Right CRL Rear Slider for Any Truck

The CRL Web Site at crlaurence.com has a simple to use feature that makes it easy for you to select the right CRL Rear Slider for any truck. Simply select the year, make, and model of the truck and we'll display your choices. What could be easier?

LOG ON TO crlaurence.com FOR BUSINESS-TO-BUSINESS SERVICES

PHONE (800) 421-6144 | FAX (800) 262-3299 TOLL FREE FROM ANYWHERE IN THE U.S.A. OR CANADA | A437



CRL TRUCK SLIDER APPLICATION CHART

For Pricing on CRL Products, Call Toll Free (800) 421-6144, or Visit crlaurence.com



CAT. NO. ECT1550S



CAT. NO. PS1460



CAT. NO. DVW1500S



TOYOTA

YEARS	MODEL	DIMENSIONS	FOUR PANEL CRL DUO-VENT				SOLAR	CRL POWR-SLIDER	GASKET
			CLEAR	LIGHT TINT	DARK TINT				
1995-2004	Tacoma	50-3/16" x 13-1/4"	DVW1500B	DVW1500LT	DVW1500BT	DVW1500S	PS1500S	WBLF5475	
			FY95038CK1	FY95038YK1	FY95038PK1	FY95039PK1			
1993-1998	All T100	58-3/8" x 14-7/8"	DVW500B	DVW500LT	DVW500BT		PS500	WBL4798	
			FY95024CK1	FY95024YK1	FY95024PK1		FY95025PK4		
1989-1995	SR5 Xtra	50-1/2" x 14-7/8"	TSW1460B	TSW1460LT	TSW1460BT		PS1460	WBL3894	
			FY95028CK1	FY95028YK1	FY95028PK1		FY95029PK4		
1984-1995	SR5 Standard	50-3/16" x 13-3/16"	TSW1400B	TSW1400LT	TSW1400BT	TSW1400S	PS1400	WBL2669 '84-'88	
			FY95026CK1	FY95026YK1	FY95026PK1	FY95036PK1	FY95027PK4	WBL2669A '89-'95	
1984-1988	SR5 Extended	51-1/4" x 15-13/16"	TSW1425B	TSW1425LT	TSW1425BT		PS1425	WBL2674	
			FY95030CK1	FY95030YK1	FY95030PK1		FY95031PK4		
1979-1983	Standard	45-3/8" x 11-1/2"	TSW1025B	TSW1025LT	TSW1025BT			WBL3971	
			FY95032CK1	FY95032YK1	FY95032PK1				
1973-1978	Standard	44-13/16" x 12-1/16"	TSW1050B	TSW1050LT	TSW1050BT			WBL1143	
			FY95033CK1	FY95033YK1	FY95033PK1				
1969-1972	Standard	46-1/2" x 12-1/8"			TSW1819T				
					FY95034PK1				

YEARS	MODEL	DIMENSIONS	THREE PANEL CRL TRI-VENT			SOLAR	CRL POWR-SLIDER	GASKET
			CLEAR	LIGHT TINT	DARK TINT			
2005+	Tacoma	55-7/16" x 15"		ECT1510LT FY95049YK5		ECT1510S FY95049PK5	EPC1510S FY95050PK5	
1999+	Tundra	60" x 16-1/2"				ECT1550S FY95044PK5	EPC1550S FY95045PK5	
1995-2004	Tacoma	50-1/16" x 13-3/16"			TRV1500BT FY95038PK4	TRV1500S FY95039PK4	PS1500S FY95040PK4	WBLF5475
1993-1998	All T100	58-3/8" x 14-7/8"			TRV500BT FY95024PK4		PS500 FY95025PK4	WBL4798
1989-1995	SR5 Xtra	50-1/2" x 14-7/8"			TRV1460BT FY95028PK4		PS1460 FY95029PK4	WBL3894
1984-1995	SR5 Standard	50-1/16" x 13-3/16"			TRV1400BT FY95026PK4		PS1400 FY95027PK4	WBL2669 '84-'88 WBL2669A '89-'95

NAGS Part Numbers are Copyright©2002 National Auto Glass Specifications (NAGS). All Rights Reserved.



LOG ON TO crlaurence.com FOR BUSINESS-TO-BUSINESS SERVICES

A438 | PHONE (800) 421-6144 | FAX (800) 262-3299 TOLL FREE FROM ANYWHERE IN THE U.S.A. OR CANADA

CRL TRUCK SLIDER APPLICATION CHART

For Pricing on CRL Products, Call Toll Free (800) 421-6144, or Visit crlaurence.com

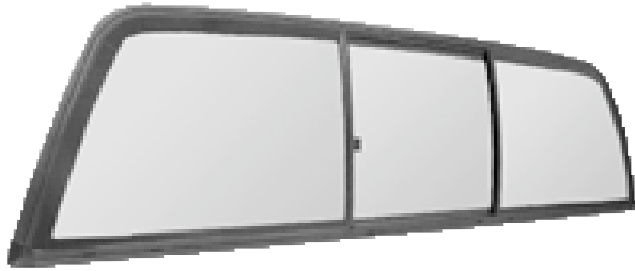

CAT. NO. ECT664S

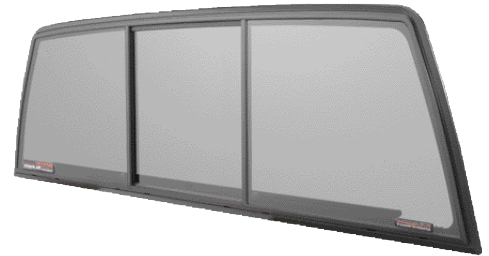

CAT. NO. EPS660S

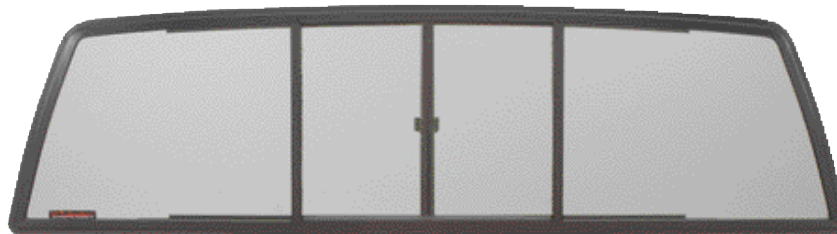

CAT. NO. DVW1060S



NISSAN/DATSUN

YEARS	MODEL	DIMENSIONS	CLEAR	FOUR PANEL CRL DUO-VENT			CRL		GASKET
				LIGHT TINT	DARK TINT	SOLAR	POWR-SLIDER		
1986.5-1997	All Cabs	53-1/2" x 14-15/16"	DVW1060B FY95016CK1	DVW1060LT FY95016YK1	DVW1060BT FY95016PK1	DVW1060S FY95035PK1	PS1060 FY95017PK4	WBL3230	
1980-1986	Standard Cab	49-1/16" x 12-3/4"	TSW1080B FY95018CK1	TSW1080LT FY95018YK1	TSW1080BT FY95018PK1		PS1080 FY95019PK4	WBL1988	
1980-1986	King Cab	52-1/8" x 14-15/16"	TSW1090B FY95020CK1	TSW1090LT FY95020YK1	TSW1090BT FY95020PK1			WBL1989	
1976-1979	King Cab	48-1/8" x 13"	TSW675B FY95022CK1	TSW675LT FY95022YK1	TSW675BT FY95022PK1			WBL1149	
1972.5-1979	Standard Cab	45-13/16" x 10-1/8"	TSW350B FY95021CK1	TSW350LT FY95021YK1	TSW350BT FY95021PK1			WBL1142	
1967-1972	Standard Cab	42-5/8" x 10-11/16"	TSW1400 FY95023CK1						

YEARS	MODEL	DIMENSIONS	CLEAR	THREE PANEL CRL TRI-VENT			CRL		GASKET
				LIGHT TINT	DARK TINT	SOLAR	POWR-SLIDER		
2005+	Frontier	54-3/8" x 15-1/8"		ECT655LT FY95051YK5		ECT655S FY95051PK5	EPC655S FY95052PK5		
2004+	Titan	63-11/16" x 17-11/16"		ECT664LT FY95047YK5		ECT664S FY95047PK5	EPC664S FY95048PK5		
1998-2004	Frontier	53-7/8" x 15-1/8"	ETRV660B FY95041CK5	ETRV660LT FY95041YK5		ETRV660S FY95042PK5	EPS660S FY95043PK5		
1986.5-1997	All Cabs	53-1/2" x 14-15/16"			TRV1060BT FY95016PK4		PS1060 FY95017PK4	WBL3230	

NAGS Part Numbers are Copyright©2002 National Auto Glass Specifications (NAGS). All Rights Reserved.

The Easy Way to Select the Right CRL Rear Slider for Any Truck

The CRL Web Site at crlaurence.com has a simple to use feature that makes it easy for you to select the right CRL Rear Slider for any truck. Simply select the year, make, and model of the truck and we'll display your choices. What could be easier?

LOG ON TO crlaurence.com FOR BUSINESS-TO-BUSINESS SERVICES

PHONE (800) 421-6144 | FAX (800) 262-3299 TOLL FREE FROM ANYWHERE IN THE U.S.A. OR CANADA | A439



CRL TRUCK SLIDER APPLICATION CHART

For Pricing on CRL Products, Call Toll Free (800) 421-6144, or Visit crlaurence.com



CAT. NO. ETRV965S

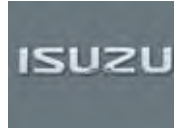

CAT. NO. EPC894S



CAT. NO. EDV965BT



MAZDA

YEARS	MODEL	DIMENSIONS	CLEAR	FOUR PANEL CRL		SOLAR	CRL	
				DUO-VENT LIGHT TINT	DUO-VENT DARK TINT		POWR-SLIDER	GASKET
1998+	All	53" x 17-13/16"	EDV965B DY90039CK2	EDV965BT DY90039PK2			EPS965S DY90040PK5	
1994-1997	Cab Plus	53" x 17-13/16"	EDV965B DY90039CK2	EDV965BT DY90039PK2			EPS965S DY90040PK5	
1994-1997	Standard	49" x 14-3/8"		7140ET Δ DB08400GT1CRL	7140EP Δ DB08400YP1CRL			Provided
1994-1997	Standard	49" x 14-3/8"	DVW1200B DY90037CK1	DVW1200LT DY90037YK1	DVW1200BT DY90037PK1		PS1200 DY90038PK4	WBL1163
1986-1993	All	50-1/8" x 14-9/16"	TSW325B FY95005CK1	TSW325LT FY95005YK1	TSW325BT FY95005PK1		PS325 FY95006PK4	WCR3098
1977-1985	Standard	48-3/4" x 13-1/16"		TSW375LT FY95002YK1	TSW375BT FY95002PK1			WBL1148
1974-1977	Rotary Engine Models	46-1/2" x 13"			TSW1319T FY95003PK1			WBL1148
1972-1976	Standard	45-1/8" x 12-5/8"	TSW1810 FY95004CK1					WBL1148

YEARS	MODEL	DIMENSIONS	CLEAR	THREE PANEL CRL		SOLAR	CRL	
				TRI-VENT LIGHT TINT	TRI-VENT DARK TINT		POWR-SLIDER	GASKET
1998+	All	53" x 17-13/16"		ETRV965LT DY90039YK5	ETRV965BT DY90039PK5	ETRV965S DY90071PK5	EPS965S DY90040PK5	
1994-1997	Cab Plus	53" x 17-13/16"		ETRV965LT DY90039YK5	ETRV965BT DY90039PK5	ETRV965S DY90071PK5	EPS965S DY90040PK5	
1994-1997	Standard	49" x 14-3/8"			TRV1200BT DY90037PK4		PS1200 DY90038PK4	WBL1163

ISUZU

YEARS	MODEL	DIMENSIONS	CLEAR	FOUR PANEL CRL		SOLAR	CRL	
				DUO-VENT LIGHT TINT	DUO-VENT DARK TINT		POWR-SLIDER	GASKET
1988-1995	All	52-11/16" x 14-3/16"	TSW610B FY95010CK1	TSW610LT FY95010YK1	TSW610BT FY95010PK1			
1986-1987	Space Cab	49-3/16" x 15-5/8"	TSW600B FY95012CK1	TSW600LT FY95012YK1	TSW600BT FY95012PK1			
1981-1987	Standard Cab	46-3/4" x 12-1/4"	TSW575B FY95000CK1	TSW575LT FY95000YK1	TSW575BT FY95000PK1			

YEARS	MODEL	DIMENSIONS	CLEAR	THREE PANEL CRL		SOLAR	CRL	
				TRI-VENT LIGHT TINT	TRI-VENT DARK TINT		POWR-SLIDER	GASKET
1996-2003	All	55-13/16" x 15-3/4"	ECT894B DY90076CK5	ECT894LT DY90076YK5		ECT894S DY90075PK5	EPC894S DY90018PK5	
1988-1995	All	52-11/16" x 14-3/16"			TRV610BT FY95010PK4			

Δ OEM Style Replacement Slider. NAGS Part Numbers are Copyright ©2002 National Auto Glass Specifications (NAGS). All Rights Reserved.



LOG ON TO crlaurence.com FOR BUSINESS-TO-BUSINESS SERVICES

A440 | PHONE (800) 421-6144 | FAX (800) 262-3299 TOLL FREE FROM ANYWHERE IN THE U.S.A. OR CANADA

CRL TRUCK SLIDER APPLICATION CHART

For Pricing on CRL Products, Call Toll Free (800) 421-6144, or Visit crlaurence.com

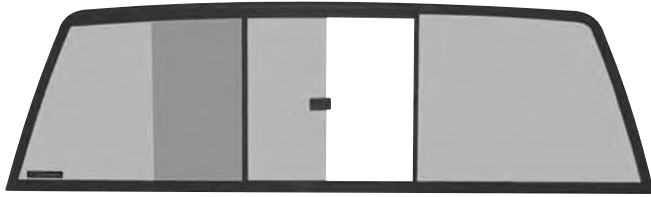

CAT. NO. TRV935BT



CAT. NO. DVW935LT



CAT. NO. EDV700BT



MITSUBISHI

YEARS	MODEL	DIMENSIONS	CLEAR	FOUR PANEL CRL DUO-VENT			SOLAR	CRL POWR-SLIDER	GASKET
				LIGHT TINT	DARK TINT				
1987-1996	All	53-1/8" x 13-7/8"	DVW935B FY95007CK1	DVW935LT FY95007YK1	DVW935BT FY95007PK1	DVW935S FY95008PK1		WBL3429	
1979-1986	Standard	46-11/16" x 14-1/16"	TSW925B FY95009CK1	TSW925LT FY95009YK1	TSW925BT FY95009PK1				
YEARS	MODEL	DIMENSIONS	CLEAR	THREE PANEL CRL TRI-VENT			SOLAR	CRL POWR-SLIDER	GASKET
				LIGHT TINT	DARK TINT				
1987-1996	All	53-1/8" x 13-7/8"			TRV935BT FY95007PK4			WBL3429	

JEEP

YEARS	MODEL	DIMENSIONS	CLEAR	FOUR PANEL CRL DUO-VENT			SOLAR	CRL POWR-SLIDER	GASKET
				LIGHT TINT	DARK TINT				
1986-1992	Comanche	56-5/8" x 16-1/4"	EDV700B DY90049CK2	EDV700LT DY90049YK2	EDV700BT DY90049PK2	EDV700S DY90070PK2			
3/1983-1986	Scrambler	46-3/4" x 17-1/4"	TSW1859 DY90051CK1						
1981-3/1983	Scrambler	47" x 17-1/4"	TSW1852 DY90052CK1						
1967-1988	J10-J20	53-1/4" x 15-3/8"			TSW1700T DY90053PK1				

INTERNATIONAL

YEARS	MODEL	DIMENSIONS	CLEAR	FOUR PANEL CRL DUO-VENT			SOLAR	CRL POWR-SLIDER	GASKET
				LIGHT TINT	DARK TINT				
1963-1978	Travel All	49-3/4" x 12-1/2"			TSW1813T DY90061PK1				

SUBARU

YEARS	MODEL	DIMENSIONS	CLEAR	FOUR PANEL CRL DUO-VENT			SOLAR	CRL POWR-SLIDER	GASKET
				LIGHT TINT	DARK TINT				
1982-1991	Brat	46" x 13"	TSW1375B FY95013CK1						
1978-1981	Brat	43-1/2" x 13-1/2"	TSW1975 FY95014CK1	TSW1975T FY95014YK1					

VOLKSWAGEN

YEARS	MODEL	DIMENSIONS	CLEAR	FOUR PANEL CRL DUO-VENT			SOLAR	CRL POWR-SLIDER	GASKET
				LIGHT TINT	DARK TINT				
1980-1983	Rabbit	45" x 14"	TSW1070B FY95015CK1	TSW1070LT FY95015YK1					

NAGS Part Numbers are Copyright ©2002 National Auto Glass Specifications (NAGS). All Rights Reserved.

LOG ON TO crlaurence.com FOR BUSINESS-TO-BUSINESS SERVICES

PHONE (800) 421-6144 | FAX (800) 262-3299 TOLL FREE FROM ANYWHERE IN THE U.S.A. OR CANADA | A441



Truck Slider Gasket Information

Prior to taking an order from your customer on a gasket set rear slider, make sure to check the information shown on the right. Even though the existing slider may have a gasket, all gaskets are not alike, and the new slider may require a new gasket. CRL Truck Sliders fit into standard OEM factory back glass gaskets.

Some pickups are equipped with a wide channel gasket (Fig. 1), on original equipment sliders. These are not acceptable for installation of CRL Truck Sliders, and must be replaced with a narrow channel gasket, such as those shown in Fig. 2.

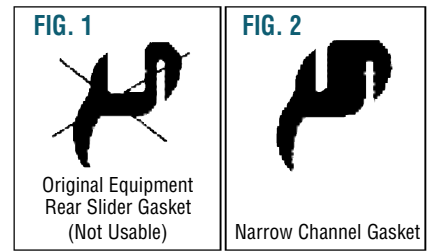

CRL Truck Slider Replacement Gaskets

- Replace Original Equipment Gaskets
- Available for Most Popular Domestic and Import Pickups

CRL Truck Slider Replacement Gaskets are made specifically for when you need to replace the original equipment gasket when installing a new backglass or rear slider. Gaskets are available for most popular domestic and import pickups. Listed below is our extensive selection of gaskets for the year, make, and model truck you are working on.



CAT. NO.	DOMESTIC TRUCK GASKETS
WKT4266	1948-1968 Chevy/GMC Small Window
WKT6266	1960-1966 Chevy/GMC Large Window
WBL1091	1967-1972 Chevy/GMC Small Window
WBL1092	1967-1972 Chevy/GMC Large Window
WBL1135	1973-1992 Chevy/GMC C/K and R/V
WBL6425	1982-1993 Chevy/GMC S-Series
WBL1103	1953-1956 Ford Full Size
WBL1015	1957-1960 Ford Full Size
WBL1052	1961-1966 Ford Full Size
WBL1089	1967-1972 Ford F-Series
WBL1158	1973-1996 Ford F-Series
WBL1148	1977-1982 Ford Courier
WBL1163	1983-1997 Ford Ranger Standard Cab
WBL1167	1994-1997 Ford Ranger Super Cab
WBL450	1999+ Ford Heavy-Duty F-Series
WBL1129	1972-1993 Dodge Ram
WBL7158	1986-1996 Dodge Dakota
WBL3429	1987-1996 Dodge D-50

CAT. NO.	IMPORT TRUCK GASKETS
WBL1148	1972-1985 All Mazda Cabs
WCR3098	1986-1993 All Mazda Cabs
WBL1163	1994-1997 Mazda Standard Cabs
WBL1167	1994-1997 Mazda Cab Plus
WBL3429	1987-1996 All Mitsubishi Cabs
WBL1142	1972-1979 Datsun Standard Cabs
WBL1149	1976-1979 Datsun/Nissan King Cabs
WBL1988	1980-1986 Datsun/Nissan Standard Cabs
WBL1989	1980-1986 Datsun/Nissan King Cabs
WBL3230	1986-1997 Nissan/Datsun All Cabs
WBL1143	1973-1978 Toyota Standard Cabs
WBL3971	1979-1983 Toyota Standard Cabs
WBL2669	1984-1988 Toyota Standard Cabs
WBL2674	1984-1988 Toyota Extended Cabs
WBL2669A	1989-1995 Toyota Standard Cabs
WBL3894	1989-1995 Toyota Xtra Cabs
WBL4798	1993-1998 Toyota T100 Cabs
WBLF5475	1995-2004 Toyota Tacoma Cabs

CRL Retail Sales Support Slider and Sunroof Display Stands

These CRL Display Stands create a much needed opportunity for your customer to review and use CRL products before they make a purchase. These Display Stands are built to the same high standards as the products they hold, featuring welded corners and powder-coated frames. Unique signage for the products is also included with these easy to assemble displays. Displays can be shipped UPS.

CAT. NO.	DESCRIPTION
WD12	Slider and Sunroof Display Stand
WD30	Double Slider Display Stand

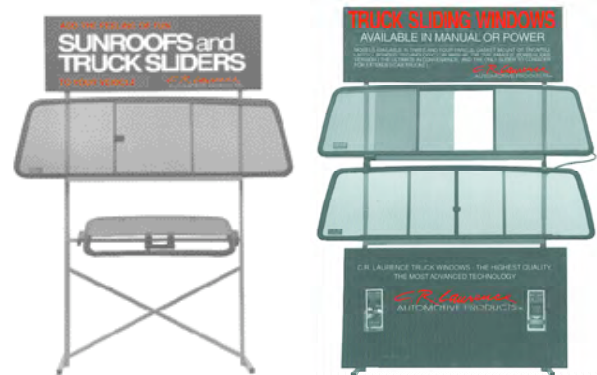

CAT. NO. WD12

CAT. NO. WD30

CRL Truck Slider Installation Videos

CRL offers video tapes that allow you to professionally train your employees in the fine art of slider installation. Videos demonstrate step-by-step instructions for the different types of sliders installation.

Visit crlaurence.com to view our available installation video library, or contact CRL Automotive Technical Sales at (800) 421-6144, Extension 7780.



CRL Slider Replacement Latches

CRL has Replacement Latches for all pickup truck sliders, three or four panel types. Whether you have one of our sliders, or another brand, we can fill your needs.

DVL2 latches fit most CRL Sliders. DVL4 is the replacement for the CRL Self-Locking Latch. DVL5 is the replacement latch for the original equipment 1995-2004 Toyota Tacoma Slider and some earlier models of Toyota trucks. DVL6 is the replacement latch for original equipment 1994 - 2000 Chevy/GMC 'C/K' three panel sliders. RL50 and RL100 are generic latches, and fit a variety of factory and aftermarket slider brands.

All latches are made from durable materials and, when mounted properly, will help secure the truck when the slider is closed.

- Fits Most CRL Sliders
- Long Lasting Durable Metal

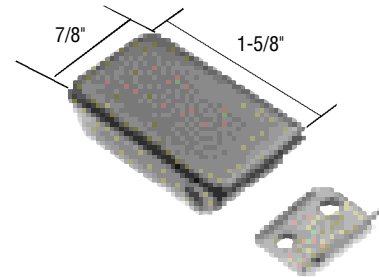

CAT. NO. DVL2

- For CRL Tri-Vent Sliders, and as a Replacement for Many OEM and Aftermarket Sliders
- Durable Self-Latching Design

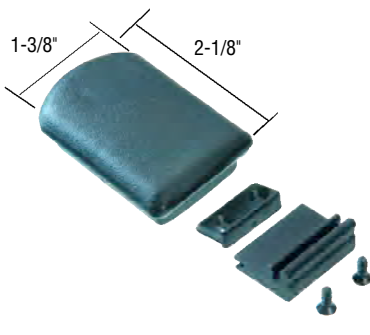

CAT. NO. DVL4AD
Latch with Adhesive and Base

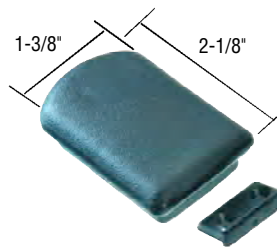

CAT. NO. DVL4
Latch Only

- Generic Latch Fits Many OEM and Aftermarket Sliders
- Durable Black Plastic Material

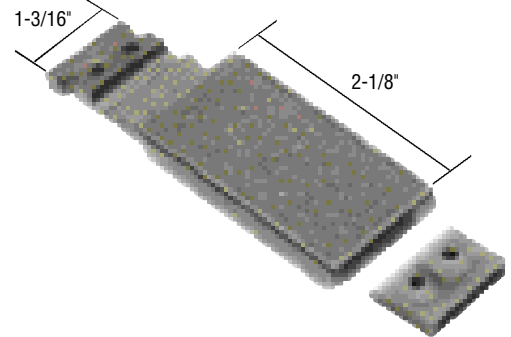

CAT. NO. RL100

- Durable Metal Latch for 1995-2004 Toyota Tacoma
- Also Fits Some Earlier Toyota Models

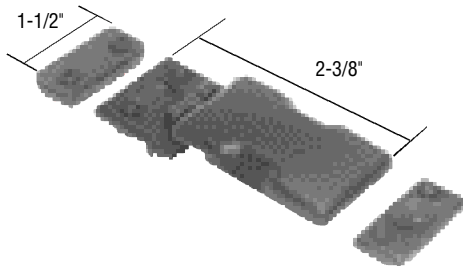

CAT. NO. DVL5

- Durable Metal Latch Fits 1994 - 2000 Chevy/GMC 'C/K' 3-Panel Sliders
- Comes with Metal-to-Glass Adhesive

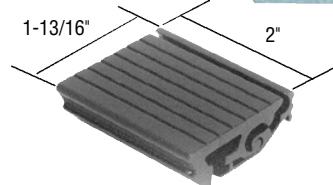

CAT. NO. DVL6

- Generic Latch Fits Many OEM and Aftermarket Sliders
- Durable Black Plastic Material

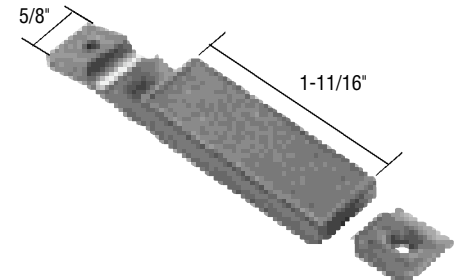

CAT. NO. RL50

CRL Cut-Out Tools for Encapsulated Rear Sliders

CRL Wildcat Pneumatic Cut-Out Knife

- Originally Designed for Rear Slider Cut-Outs
- Cuts Through Hardened Urethane with Ease
- Oscillates at Over 20,000 RPM

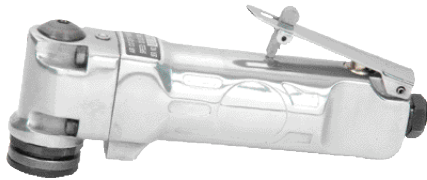

CAT. NO. AK20TOOL
Wildcat Knife Only

For complete details, see page A185.



CAT. NO. AK10
Wildcat Knife Kit

CRL POWR-Cat Cut-Out Knife

- Uses All Six and Twelve Sided Mount Cut-Out Blades
- Heavy-Duty Industrial Grade Air Motor
- Longer Housing for Ease of Handling

For complete details, see page A184.

CRL POWR-Cat Cut-Out Knife Kit

- A Complete Cut-Out System with an AK60TOOL, Four Different Cut-Out Blades, and Accessories
- Industrial Grade Air Motor Delivers Over 20,000 Oscillations Per Minute

For complete details, see page A184.

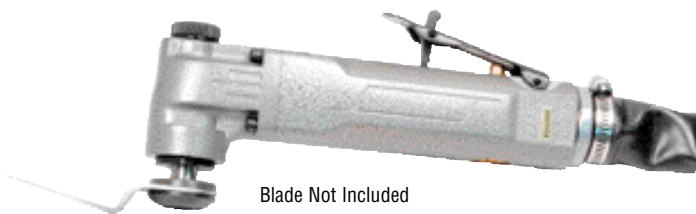

CAT. NO. AK60TOOL
POWR-Cat Knife Only



CAT. NO. AK70
POWR-Cat Knife Kit

CRL Fein Auto Glass Removal Tools

- 28% More Power Than Previous Models
- A Variety of Blades for Virtually All Cut-Outs
- Adjustable Speed Control

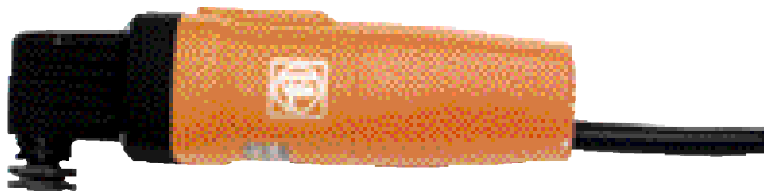

CAT. NO. FK06
Fein Cut-Out Knife Only

For complete details, see page A196.



CAT. NO. FK6385
Fein Cut-Out Knife Kit



CRL Backglass Removal Blades

- Fits Wildcat, POWR-Cat, and Other Cut-Out Knives Using a Six or Twelve Sided Blade Mount
- Ideal for Removing Urethane Set Backlites



CAT. NO. AKB200



CAT. NO. AKB300

The CRL AKB200 Standard Blade is made of tempered tool steel with sharply ground edges to slice through hard urethane sealants. Its size and shape make it the best blade for cutting out urethane set backlites in pickups. The AKB300 Blade has been made with a contour that is different from our Standard Blade. It's designed specifically for use with 1994 - 2001 Dodge Ram pickups.

CAT. NO.	BLADE DESCRIPTION
AKB200	Standard Cut-Out
AKB300	1994 - 2001 Dodge Ram Pickup

CRL Deluxe Windshield Knife

- Uses All Standard Cold Knife Blades
- Simple and Effective



CAT. NO. RK160

The CRL Deluxe Windshield Knife provides a simple and proven method to remove automotive windows. A strong tempered steel blade, sharpened to a fine cutting edge, with a large durable aluminum handle, combined with steel cable pull handle assures the easiest and fastest way of cutting the adhesive around the window.

See pages A168-A175 for our complete line of Cold Knives.

CRL Encapsulated Back Glass Removal Blade

- Fits All Oscillating Cut-Out Knives Using Six or Twelve Sided Blade Mount
- No Need to Remove Headliner

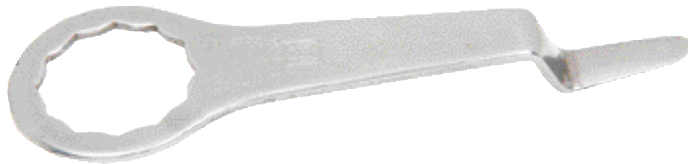

CAT. NO. RD924

For details on this blade, see page A186.

CRL Cold Knife Blades

- A Variety of Designs to Fit Most Popular Cold Knives



CAT. NO. AN1001



CAT. NO. AN1002



CAT. NO. AN1004



CAT. NO. RKB141

See pages A169-A175 for our complete line of Cold Knife Blades.

CRL Oscillating Blades

- Oscillating Blades for Cut-Out Knives Using Six or Twelve Sided Blade Mount
- Wide Range of Sizes and Styles

See pages A186-A189 for our complete line of CRL Oscillating Cut-Out Blades.



CAT. NO. RD081



CAT. NO. RD097



CAT. NO. FKB100



CAT. NO. FKB207



CAT. NO. FKB211

CRL POWR Urethanes and Primers

• The Best Adhesives for Installing Encapsulated Rear Sliders

See pages A110-A114 for a complete listing of CRL Automotive Urethanes and Adhesives.



CRL Rear Slider Installation Kit

• Contains All Necessary Tools for Gasket Mounted Sliders

CRL's Rear Slider Installation Kit contains all the tools necessary to successfully install most gasket mounted truck sliders.

Kit Includes:

20 Ft. (6.1 m) of 1.8" (3.2 mm) Nylon Rope, One HC45 Hand Cleaner/Lubricant, One CRL216 Windshield Stick, and One CP253 Hook Tool.



CAT. NO. DV1K

CRL's Rope Insert Tool for Rubber Gaskets

- Makes "Roping-In" Easy
- Comfortable Grip



CAT. NO. RT752

CRL's Rope Insert Tool inserts the rope into the groove of rubber gaskets to make the job easier than ever. The counter-grip plastic handle feeds rope through its stem as you pull it around the gasket, and has enough sturdy rope to fit around even the largest backlites or rear truck sliders. Extra handy for all installers.

CRL Slider Buddy Installation Tool

- Speeds Installation Time
- Allows One Man Installations



CAT. NO. BST1

CRL's Slider Buddy Installation Tool will speed your installation time and cut your labor costs. CRL's Slider Buddy saves from having a second installer hold the slider in place while the installer applies the retainer clips or bend over tabs on the interior. Easy to use, just insert between the cab and the bed of the truck, adjust the height to center the pads on the middle of the fixed panels, and then pump the handle until contact with the glass is made. Minimal pressure is required to hold the slider in place.

CRL Series-E Clip Insertion Tool

- Use with CRL Installation Clips
- Makes Clip Installations Easy



CAT. NO. RC1T

The CRL Clip Insertion Tool, while simple in design, does the job beautifully. The jaws of the tool are machined with recesses so proper grip depth is assured. A handle is welded on the side of the tool so articulation of the tool can be accomplished without your hand pressing against the glass of the slider. This tool securely grips the Installation Clip so accurate placement can be made without deflection.

CRL Magnetic Clip Insertion Tool

- Used for the Quick Insertion of Installation Clips

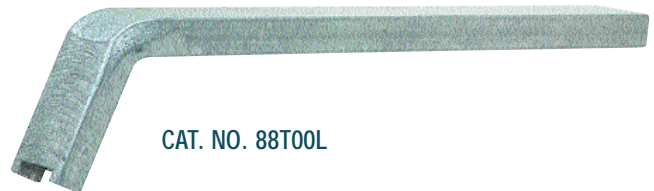

CAT. NO. 88TOOL

Use our CRL Magnetic Clip Insertion Tool with the clips shown below for fast installations. Magnet holds clip in position for easy insertion.

CRL Installation Clips for Series-E Sliders

- Secures Slider While Urethane Cures

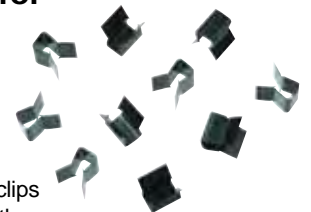

CRL offers two types of installation clips for Series-E Sliders. Clips will secure the encapsulated slider to the pinchweld while the urethane sets. Use our RC1T Series-E Clip Insertion Tool for easy installation. 10 per package.

CAT. NO.	COLOR	APPLICATION
DP130	Black	1988 - 2000 Chevy/GMC; 1994 - 1996 Dodge Dakota
DP161	Silver	1994 - 2001 Dodge Ram



CRL Truck Cap Accessories

CRL has accessories for the repair or mounting of Truck Caps of virtually any type.

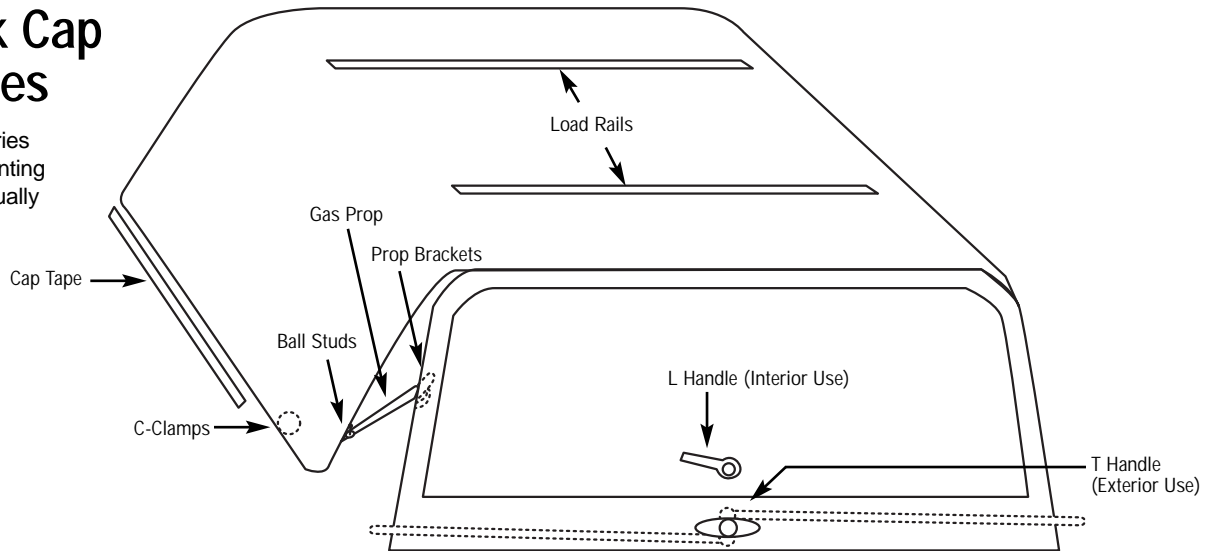

CRL Truck Cap Foam Seal Tape

- Closed Cell Silicone-Based Truck Cap to Truck Bed Seal

This CRL Truck Cap Foam Seal Tape is a closed cell, silicone-based, automotive grade weather seal material. This Foam Seal Tape has excellent memory, and will keep drafts and water out of the truck bed when used to install a truck cap.



NOTE: Use our CRL Truck Cap C-Clamps RM608003, RM608004, and RM608011 (see below) to retain the cap to the bed without drilling any holes.

CAT. NO.	THICKNESS	WIDTH	COLOR	FT/RL	RLS/CS
60701	1/4" (6.4 mm)	1/2" (12.7 mm)	Black	50 (15.2 m)	60

CRL Campermount® Tape

- Cushioning Tape for Camper Tops and Truck Caps

The ideal way to seal camper tops and pickup truck caps.

Each foam cell acts like a tiny shock absorber to reduce vibration and eliminate metal-to-metal contact. CRL Campermount® Tape is also easy to apply. It has a pressure-sensitive acrylic adhesive on one side and a paper liner that ensures simple non-stretch installation. Comes individually poly-bagged for dealer use or retail sales. Each roll contains 50 feet (15.2 m) of tape, plenty to do one installation.



CAT. NO.	THICKNESS	WIDTH	COLOR	FT/RL	RLS/CS
V666316	3/16" (4.8 mm)	1" (25.4 mm)	Gray	50 (15.2 m)	20
V66614	1/4" (6.4 mm)	1" (25.4 mm)	Gray	50 (15.2 m)	20

CRL C-Clamps for Truck Caps

- For Aluminum Rails



CRL C-Clamps for Truck Caps with aluminum rails will secure your truck cap to the pickup bed. Extruded aluminum structural alloy with a natural finish.

CAT. NO.	QTY/PKG
RM608003	1

CRL C-Clamps for Truck Caps

- For Fiberglass Rails



CRL C-Clamps for Truck Caps with fiberglass rails will secure your truck cap to the pickup bed. Extruded aluminum structural alloy with a natural finish.

CAT. NO.	QTY/PKG
RM608004	1

CRL C-Clamps for Truck Caps

- For 1999+ Ford Super Duty Caps with Aluminum Rails



CRL C-Clamps for 1999+ Ford Super Duty Truck Caps with aluminum rails will secure your truck cap to the pickup bed. Extruded aluminum structural alloy with a natural finish.

CAT. NO.	QTY/PKG
RM608011	1

CRL Load Rails

- Increase Carrying Capacity of Truck Caps
- Ideal for Bulky Items (Up to 200 Pounds/90 kg)
- Black Electro-Static Powder-Coat Finish
- Available for Vans, Plus Truck Caps for Full Size and Smaller Trucks



Shown with Mounting Legs, which must be ordered separately

Our CRL Load Rails are made of extruded aluminum with a black electro-static powder-coated finish. CRL Load Rails include steel "tie downs" bolted to the ends to keep the load from sliding, and PVC inserts to protect loads from being damaged. **NOTE:** Mounting Legs (shown below) are sold in sets, and must be ordered separately from Load Rails.

CAT. NO.	DESCRIPTION
CR5400	Set of Two 54" (137 cm) Load Rails
CR6400	Set of Two 64" (162 cm) Load Rails

CRL Mounting Legs for Load Rails

CRL Mounting Legs are made of aluminum extrusion with a black electro-static powder-coated finish, and are available in three heights to accommodate the variety of camper shells. **NOTE:** Load Rails are sold in sets, and must be ordered separately from Mounting Legs.

- Made of Aluminum Extrusion with a Black Electro-Static Powder-Coated Finish
- Available in Three Heights

3/4" Mounting Legs

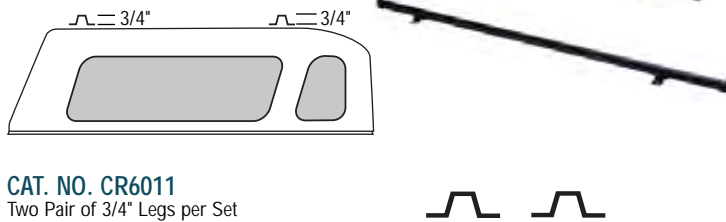

CAT. NO. CR6011
Two Pair of 3/4" Legs per Set

3/4" and 2" Mounting Legs

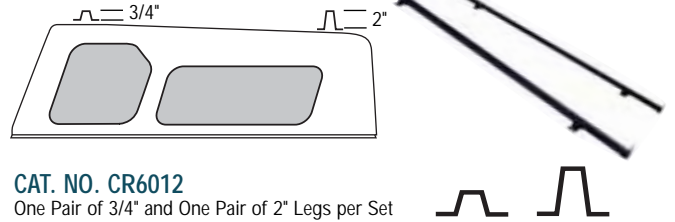

CAT. NO. CR6012
One Pair of 3/4" and One Pair of 2" Legs per Set

3/4" and 4" Mounting Legs

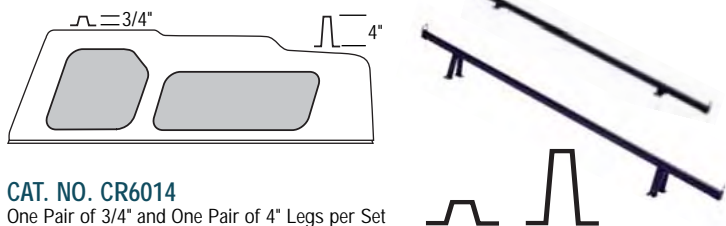

CAT. NO. CR6014
One Pair of 3/4" and One Pair of 4" Legs per Set

2" Mounting Legs

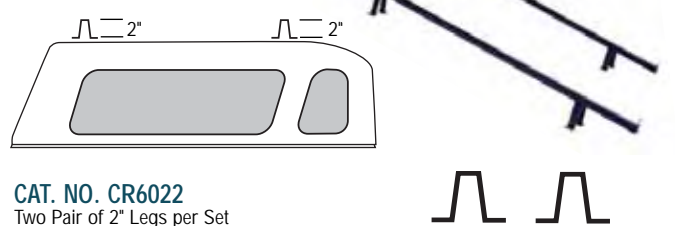

CAT. NO. CR6022
Two Pair of 2" Legs per Set

2" and 4" Mounting Legs

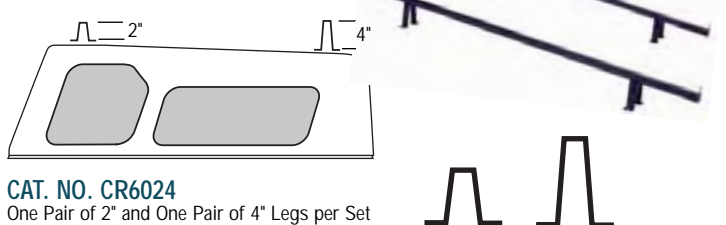

CAT. NO. CR6024
One Pair of 2" and One Pair of 4" Legs per Set

4" Mounting Legs

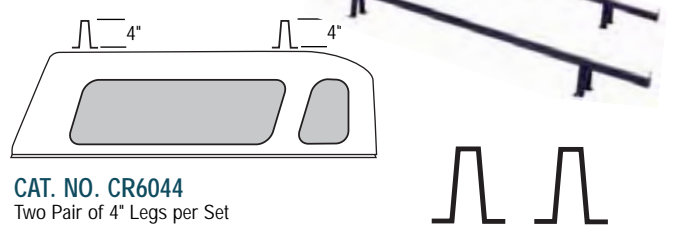

CAT. NO. CR6044
Two Pair of 4" Legs per Set



CRL Truck Cap L-Handle

- Injection Molded Black Nylon
- Fits 1/4" Shaft

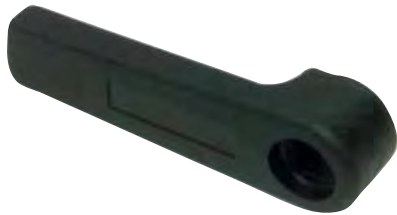

CAT. NO. 75504

CRL Truck Cap Interior L-Handles are injection molded black nylon for high strength and durability. These inside opening CRL L-Handles fit truck cap radius, mitered and fiberglass rear doors. Pressure fit to 1/4" (6.4 mm) shafts.

CRL Truck Cap Gas Lift Props

- Prop Pressure Assists Opening
- 5/8" Diameter Black Painted Steel Barrels



CRL Truck Cap Gas Lift Props are perfect for radius, mitered or fiberglass doors, egress windows, side access windows, or any installation where prop pressure would assist in an opening application. Gas filled props have 5/8" (16 mm) diameter black painted steel barrels, 15/64" (6 mm) diameter stainless steel rods and 25/64" (10 mm) ball socket ends.

CAT. NO.	DESCRIPTION
520030	35 lb Prop - 17" (43.2 cm) Open - 10" (25.4 cm) Closed
520040	40 lb Prop - 17" (43.2 cm) Open - 10" (25.4 cm) Closed
520050	50 lb Prop - 17" (43.2 cm) Open - 10" (25.4 cm) Closed
515040	40 lb Prop - 15" (38.1 cm) Open - 9" (22.9 cm) Closed
510030	35 lb Prop - 12" (30.5 cm) Open - 8" (20.3 cm) Closed
510040	40 lb Prop - 12" (30.5 cm) Open - 8" (20.3 cm) Closed

CRL 90° Bend Prop Bracket

- 10 mm Ball Socket
- Black Zinc Finish



CAT. NO. 755070

CRL 90° Bend Prop Brackets for Gas Lift Props have a 10 mm ball socket and are built to high specifications. Made from 14 gauge steel with a black zinc finish.

CRL 20° Offset Prop Bracket

- 10 mm Ball Socket
- Black Zinc Finish



CAT. NO. 755071

CRL 20° Offset Prop Brackets for Gas Lift Props have a 10 mm ball socket and are built to high specifications. Made from 14 gauge steel with a black zinc finish.

CRL 10 mm Threaded Ball Stud

- For Use with Most Gas Lift Props
- Black Zinc Finish

CRL 10 mm Threaded Ball Studs for Gas Lift Props have a 10 mm ball socket and are built to high specifications with a black zinc finish.



CAT. NO.	DESCRIPTION
759054	5/16" - 18 x .540" (13.7 mm) Thread
759917	1/4" - 20 x .375" (9.5 mm) Thread

CRL Truck Cap T-Handles

CRL Truck Cap T-Handles for Glass Doors are all aluminum diecast with a powder-coated black finish. They provide 90° right and left rotations. The key cylinder has a dust cover and comes with two keys. NOTE: T-Handles are randomly keyed.

- 2-1/2" Wide T-Handle



1-3/8" Long Shaft,
2-1/2" Wide T-Handles;
1 Pair per Package

CAT. NO. 759911

- 4" Wide T-Handle



2-1/2" Long Shaft,
4" Wide T-Handles;
1 Pair per Package

CAT. NO. 755020

- 4" Wide T-Handle



2-1/2" Long Shaft,
4" Wide T-Handle;
1 per Package

CAT. NO. 75501

CRL RV and Camper Door Locking T-Handle

- Metal Diecast
- Bright Chrome Finish



CAT. NO. R7044
1 per Package

This CRL Truck Cap Locking T-Handle is all metal diecast for any three point or single cam locking system. For use in radius, mitered, or fiberglass rear doors. Lock provides 90° right or left hand rotation. Bright chrome finish with randomly keyed cylinder. 5/16" (16 mm) square shaft is 4" (102 mm) long.



The Worldwide Symbol for Sunroof Excellence

Right after the turn of the new century, CRL acquired SFC Sunroofs to make possible our goal of providing the aftermarket with industry leading sunroofs. SFC Sunroofs has been at the forefront of sunroof evolution for over 25 years, having introduced many major sunroof innovations, including high performance, glare-reducing glass, superior UV protection, and bonded glass.

SFC Sunroofs was the first manufacturer to address the special roof configuration of today's aerodynamic styling. Every item in the growing SFC/CRL Sunroof product line is designed to offer superior quality, easy installation, and years of trouble-free operation. With our network of warehouse locations and tremendous inventory, CRL offers sunroof buyers the best of both worlds.

NewPort

• Contemporary Curved Leading Edge

If you are looking for OEM style fit and finish, our NewPort is the sunroof. The NewPort Series offers six different sizes to fit the largest percentage of vehicles. The Newport has a curved leading edge, low profile framework, positive locking Bio-Mechanical Latch,

easy glass removal and replacement, and of course, Hi-Performance glass with 92% ultraviolet protection. With all of these features, it's no wonder that each year more NewPort Sunroofs are installed than any other pop-up sunroof in America. See page A453.



AutoPort

• Traditional Design

The AutoPort Sunroof is known in the industry for its unsurpassed fit and finish, offering the highest quality at a conservative price. Perfect for replacement of older sunroofs as well as new installations. The AutoPort's traditional design with flush fit and Hi-Performance solar glass will provide you with a good looking sunroof at an affordable price. See page A452.



Our manufacturing facilities are located in Vernon, California, where our automotive products are manufactured under the strictest of standards. C.R. Laurence Automotive Products Division is a supplier to several original equipment manufacturers, as well as many major glass industry distributors.



LOG ON TO crlaurence.com FOR BUSINESS-TO-BUSINESS SERVICES

A450 | PHONE (800) 421-6144 | FAX (800) 262-3299 TOLL FREE FROM ANYWHERE IN THE U.S.A. OR CANADA

Genesis

• Bonded Glass Design

The Genesis Sunroof is just like the name implies, a new beginning. The Genesis has all the features that will create an OEM look, plus hidden hinge and latch hardware. Using bonded technology, the engineers at SFC/CRL have created the first sunroof to feature glass with completely bonded hardware, allowing for no exposed buttons. This breakthrough technology allows for a smooth, uninterrupted exterior glass finish with no latch or hinge hardware covers, giving the look of a power sunroof at a pop-up price. The patented Cam-Lock System makes installations a breeze, and the interior of the vehicle is kept cool with high performance glass that offers 92% ultraviolet light protection. See page A454.



Electric Spoiler Sunroofs

Want an electric powered sunroof? The ES Series of Electric Spoiler Sunroofs is the top choice for installers and vehicle owners. Easy installation and OEM finish provides you with everything you could want in an electric sunroof. High performance dark tint solar privacy glass lets the sun shine in while maintaining interior comfort. Our ES Series Electric Spoiler Sunroofs are offered in two sizes, 18" x 31" and 20" x 32". ES100 and ES300 models offer the option of retractable screen sunshades, while the 20" x 32" ES500 comes standard with the Variolite® Sliding Sunshade. See page A456.

• Luxury and Convenience

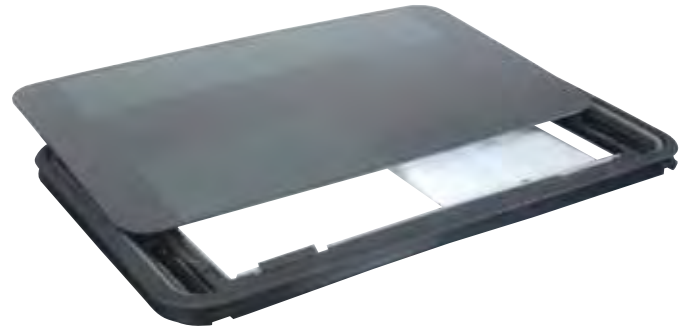

Specialty Sunroofs

• For Special Vehicles



Special needs require special applications. SFC/CRL covers the bases with a variety of sunroofs that address specific makes and models. Jeep Cherokees require a sunroof with special "indents" in the upper surface to go over the roof ridges. Trucks and Vans with center overhead consoles limit the space to install a single sunroof. His 'N Hers Sunroofs, which can be installed in varying positions, solve that difficult problem. Our Specialty Sunroofs feature exact tolerances, cosmetic appeal and, of course, our high performance glass with 92% ultraviolet light protection. See pages A455.

Sunroof Accessories

SFC/CRL Sunroof accessories include Wind Deflectors, Storage Bags for glass panels, and Sunshades. See pages A457-A458.

Sunroof Parts

We have a large selection of replacement parts for many different brands of sunroofs. Whatever your need, a replacement glass panel, front hinges, rear latches, trim rings or gaskets, the CRL Automotive Technical Sales Department is at your service to find the right part to repair your sunroof. See pages A461-A465.



The Worldwide Symbol for Sunroof Excellence

With its contemporary and traditional design, the AutoPort Sunroof is ideal for car, truck, or van applications. It features flush fitting high performance solar glass that is easily removed and replaced, providing 92% UV protection. The interior trim ring can be installed under or over the headliner, depending on the application or customer preference. AutoPort delivers remarkable quality with unsurpassed fit and finish, offering the budget minded consumer a remarkable combination of style and value.

AutoPort

- Traditional Design Replaces Most Other Sunroofs on the Market
- Solar High Performance Glass Provides 92% UV Protection
- Glass Can Be Quickly and Easily Removed
- Flush Fitting Frame with Weather-Tight Silicone Seal
- Latch Has Two Open Positions



Technical Data

FRAME SIZE:

16-3/16" x 31-3/16" O.D. (15" x 30")
18-3/16" x 36-3/16" O.D. (17" x 35")

CUT-OUT SIZE:

15-1/8" x 30-1/8" (15" x 30")
17-1/8" x 35-1/8" (17" x 35")

GLASS SIZE:

13-5/8" x 28-5/8" (15" x 30")
15-5/8" x 33-5/8" (17" x 35")

FRAME:

Extruded Aluminum,
Black Powder-Coated Paint

HANDLE:

Three Position,
Positive Latching

SEAL:

Extruded Silicone Sponge

TRIM RING:

Universal and Molded

15" X 30" AUTOPORT SUNROOFS

CAT. NO.	GLASS	TRIM RING*
AP1530B5H	Solar H.P.	Universal
AP1530B6H	Solar H.P.	Molded

17" X 35" AUTOPORT SUNROOFS

CAT. NO.	GLASS	TRIM RING*
AP1735B5H	Solar H.P.	Universal
AP1735B6H	Solar H.P.	Molded
AP1735B4H	Solar H.P.	Van

*For the correct trim ring application, ask your trim specialist, or the SFC/CRL Auto Technical Center.

All Sunroofs can be combined for quantity pricing.



LOG ON TO crlaurence.com FOR BUSINESS-TO-BUSINESS SERVICES

A452 | PHONE (800) 421-6144 | FAX (800) 262-3299 TOLL FREE FROM ANYWHERE IN THE U.S.A. OR CANADA



The Worldwide Symbol for Sunroof Excellence

NewPort

- Contemporary Radius Corner Design with Curved Leading Edge
- Solar High Performance Glass Provides 92% UV Protection
- Six Sizes to Fit Most Cars, Trucks, SUV's, and Vans
- Dual Contour Frames and Glass on 18" x 28" and 20" x 32" Models
- Flush Fitting Frame with Weather-Tight Silicone Seal
- Bio-Mechanical Latch with Two Opening Positions

From small economy to high-end cars and trucks, NewPort Sunroofs are the answer. The installation of NewPort Sunroofs is simple. Shipped assembled and ready to install, the universal and molded trim rings provide numerous installation trim options. The aluminum spacer within the universal trim ring provides better compression between the sunroof and the car body. The molded trim ring comes with styrofoam spacers that hold the headliner tightly against the inside trim ring. From the 14" x 32" to the 22" x 38", and everything in between, the curved leading edge, low frame-to-body profile, and contemporary corner design of a NewPort Sunroof follows vehicle lines to perfection.



The Solar High Performance Glass used in all NewPort Sunroofs provides 92% UV protection. It's also easy to remove for that "top down feeling". 18" x 28" and 20" x 32" dual contour models conform to the round roof lines of today's most popular vehicles.

Technical Data

FRAME SIZE:

14-9/16" x 32-3/16" O.D. (14" x 32")
16-13/16" x 36-13/16" O.D. (16" x 36")
16-7/8" x 32-3/16" O.D. (17" x 32")
18-13/16" x 28-13/16" O.D. (18" x 28")
20-13/16" x 32-3/16" O.D. (20" x 32")
23-1/16" x 39-1/16" O.D. (22" x 38")

CUT-OUT SIZE:

13-3/4" x 31-3/8" (14" x 32")
16" x 36" (16" x 36")
16-1/16" x 31-3/8" (17" x 32")
18" x 28" (18" x 28")
20" x 31-3/8" (20" x 32")
22" x 38" (22" x 38")

GLASS SIZE:

12-1/2" x 30-1/8" (14" x 32")
14-3/4" x 34-3/4" (16" x 36")
14-13/16" x 30-1/8" (17" x 32")
16-3/4" x 26-3/4" (18" x 28")
18-3/4" x 30-1/8" (20" x 32")
20-3/4" x 36-3/4" (22" x 38")

FRAME:

Extruded Aluminum,
Black Powder-Coated Paint

HANDLE:

Three Position,
Positive Latching

SEAL:

Extruded Silicone Sponge

TRIM RING:

Universal and Molded

14" X 32" NEWPORT SUNROOFS

CAT. NO.	GLASS	TRIM RING*
NP1432B5H	Solar H.P.	Universal
NP1432B6H	Solar H.P.	Molded

16" X 36" NEWPORT SUNROOFS

CAT. NO.	GLASS	TRIM RING*
NP1636B5H	Solar H.P.	Universal
NP1636B6H	Solar H.P.	Molded

17" X 32" NEWPORT SUNROOFS

CAT. NO.	GLASS	TRIM RING*
NP1732B5H	Solar H.P.	Universal
NP1732B6H	Solar H.P.	Molded

18" X 28" NEWPORT SUNROOFS

CAT. NO.	GLASS	TRIM RING*
NP1828B5H	Solar H.P.	Universal
NP1828B6H	Solar H.P.	Molded
NP1828B5H Δ	Solar H.P.	Universal
NP1828B6H Δ	Solar H.P.	Molded

Δ Dual Contoured Model

20" X 32" NEWPORT SUNROOFS

CAT. NO.	GLASS	TRIM RING*
NP2032B5H Δ	Solar H.P.	Universal
NP2032B6H Δ	Solar H.P.	Molded

Δ Dual Contoured Model

22" X 38" NEWPORT SUNROOFS

CAT. NO.	GLASS	TRIM RING*
NP2238B5H	Solar H.P.	Universal
NP2238B6H	Solar H.P.	Molded

*For the correct trim ring, contact your trim specialist, or the SFC/CRL Auto Technical Center.

All Sunroofs can be combined for quantity pricing.





Genesis



- Bonded Glass Design with No Exposed Hardware
- Solar High Performance Glass Can Be Completely Removed, and Provides 92% UV Protection
- Bio-Mechanical Latch with Two Opening Positions
- Ultra-Thin Exterior Aluminum Frame with Weather-Tight Silicone Seal
- Patented Cam-Lock System Ensures the Easiest of Installations

The Genesis is an entirely new class of sunroof, offering the easiest of pop-up installations. Genesis brings sunroof style and installation to a new level. Features unlike any other sunroof combine the upscale appearance of an in-built, with the ease of installation of a pop-up. This is the ideal sunroof for consumers who want the best of both worlds.

Genesis comes ready for quick, fully wrapped headliner installation with a patented Cam-Lock System that gives a positive clamping between the frame and vehicle roof. The bonded glass and ultra-thin exterior frame provide the look of an expensive in-built sunroof at a price everyone can afford. Genesis is the ideal sunroof for most any application.



Technical Data

FRAME SIZE:

15-1/4" x 28-3/4" O.D. (15" x 28")
16-3/4" x 31-3/4" O.D. (17" x 32")
20-9/16" x 32-5/8" O.D. (20" x 32")

CUT-OUT SIZE:

14-5/8" x 28-1/8" (15" x 28")
16-1/8" x 31-1/8" (17" x 32")
20" x 32-1/16" (20" x 32")

GLASS SIZE:

14" x 27-1/2" (15" x 28")
15-1/2" x 30-1/2" (17" x 32")
19-5/16" x 31-5/16" (20" x 32")

FRAME:

Extruded Aluminum,
Black Powder-Coated Paint

HANDLE:

Three Position,
Positive Latching

SEAL:

Extruded Silicone Sponge

TRIM RING:

Universal

15" X 28" GENESIS SUNROOF

CAT. NO.	GLASS	TRIM RING
GS1528BH	Solar H.P.	Universal

17" X 32" GENESIS SUNROOF

CAT. NO.	GLASS	TRIM RING
GS1732BH	Solar H.P.	Universal

20" X 32" GENESIS SUNROOF

CAT. NO.	GLASS	TRIM RING
GS2032BH	Solar H.P.	Universal

All Sunroofs can be combined for quantity pricing.



LOG ON TO crlaurence.com FOR BUSINESS-TO-BUSINESS SERVICES

A454 | PHONE (800) 421-6144 | FAX (800) 262-3299 TOLL FREE FROM ANYWHERE IN THE U.S.A. OR CANADA



His 'N Hers Sunroofs

- Perfect for Vans and Trucks
- Independently Adjustable



17" X 17" HIS 'N HERS SUNROOFS

CAT. NO.	GLASS	TRIM RING*
VT1717B4H	Solar H.P.	Van
VT1717B5H	Solar H.P.	Universal
VT1717B6H	Solar H.P.	Molded

*For the correct trim ring application, ask your trim specialist, or the SFC/CRL Auto Technical Center. All Sunroofs can be combined for quantity pricing.

Two words describe the His 'N Hers Sunroof: versatile and practical. The compact 17" x 17" size makes this sunroof the perfect choice for use as either a single or double unit. Placed side by side, they offer installation flexibility, as well as separate control of ventilation for individual comfort. The high performance solar glass can be removed easily for the exhilaration of "open-top" driving. The factory styling of this sunroof is also popular with van enthusiasts. Single units can be installed over the back portion of the vehicle to illuminate and ventilate the rear compartment. Trucks and vans with center overhead consoles limit the space to install a single sunroof. Our His 'N Hers Sunroofs are the solution.

Technical Data

FRAME:

Extruded Aluminum,
Black Powder-Coated Paint

HANDLE:

Three Position,
Positive Latching

SEAL:

Extruded Silicone Sponge

TRIM RINGS:

Universal, Molded and Van
(His 'N Hers)

FRAME SIZE:

17-5/8" x 17-5/8" O.D. (His 'N Hers)
18-3/16" x 36-3/16" O.D. (AutoPort)

CUT-OUT SIZE:

16-5/8" x 16-5/8" (His 'N Hers)
17-1/8" x 35-1/8" (AutoPort)

GLASS SIZE:

15-1/8" x 15-1/8" (His 'N Hers)
15-5/8" x 33-5/8" (AutoPort)

Jeep Cherokee AutoPort Sunroof

- Specially Designed Frame to Go Over Roof Ridges of the 1991 Through 2001 Jeep Cherokee
- High Performance Glass Provides 92% UV Protection

Jeep Cherokees from 1991 through 2001 require a special sunroof with indents to go over the roof ridges. This AutoPort Sunroof meets those requirements while maintaining all of the quality features that make the AutoPort so popular. The high performance glass provides 92% UV protection. The extruded aluminum frame has a black powder-coated paint finish, extruded silicone sponge seal, and a three position handle.

17" X 35" JEEP CHEROKEE AUTOPORT SUNROOF

CAT. NO.	GLASS	TRIM RING
AP1735B5H1	Solar H.P.	Universal

All Sunroofs can be combined for quantity pricing.



CRL Electric Spoiler Sunroofs

- Illuminated Switch Gives Convenient Push-Button Open and Close Operation
- Extremely Low Profile, with No Exposed Exterior Hardware
- Dark Tint Solar Privacy Glass
- Multiple Position Flexibility Adds Luxury and Style to Any Car or Truck

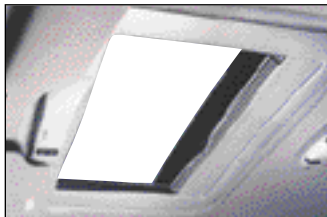
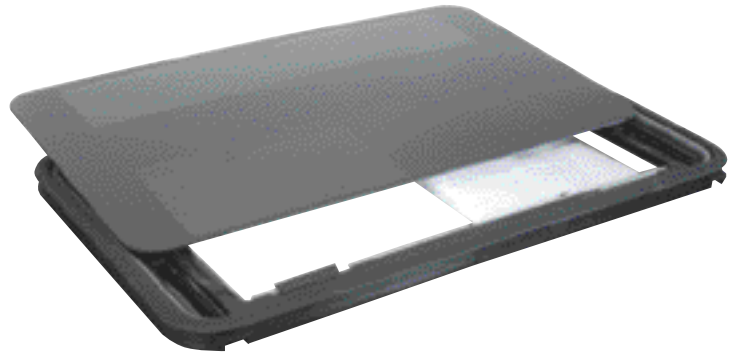

Variolite® Sunshade in full open position.



Variolite® Sunshade shown closed with European Trim Finish.



Optional Retractable Screen Sunshades

Retractable Screen Sunshades are easy to install, and available for both sizes of the Electric Spoiler Sunroof.



Optional Dome Lamp

Incorporates a built-in switch for convenient operation, and is integrated into the inner trim for a factory finished appearance.

The convenient design and function of the CRL Electric Spoiler Sunroof offers multiple positioning of the flush, factory-style tempered safety glass. With just a touch of the illuminated switch, the Electric Spoiler Sunroof can be vented, closed, or opened up to 12-1/4". With its built-in air deflector and flush-mount, thin line frame, this CRL Sunroof is a plus for any vehicle.

Dark tint solar privacy glass lets the sun shine in while maintaining interior comfort. Our 20" x 32" model ES500 has a built-in Variolite® Sunshade that slides open and shut, allowing fresh air to enter while keeping sunlight out.

Our ES100 and ES300 models have all of the great features of the ES500. Optional spring-loaded Sunshade Screens attach with screws, and are concealed when not in use. The ES300 is the same size as ES500, while the 18" x 31" ES100 is a great choice for narrow rooflines and compact vehicles. Whichever size you choose, CRL Electric Spoiler Sunroofs are an excellent alternative to factory-installed electric sunroofs.



CAT. NO.	DESCRIPTION
ES500	20" X 32" Sunroof with Variolite Sunshade
ES300	20" x 32" Sunroof without Sunshades
ES100	18" x 31" Sunroof without Sunshades
SS1300	Optional Retractable Sunshades (Pair) for ES300
SS1100	Optional Retractable Sunshades (Pair) for ES100
RM175	Optional Dome Lamp for All Models

All Sunroofs can be combined for quantity pricing.

Technical Data

OPERATION: Electric, with Optional Illuminated Switch

FRAME: Composite Polymer

SEAL: 100% Silicone

WARRANTY: 5 Year Limited

CAT. NO.	FRAME SIZE	GLASS SIZE	CUT-OUT SIZE	INTERIOR TRIM	DAYLIGHT OPENING	OPTIONAL SUNSHADES
ES500	20" X 32-1/4"	18-1/4" X 30-3/4"	18-3/4" X 31-3/8"	24" x 33-1/4"	12-3/4" x 24-1/2"	INTEGRATED
ES300	20" X 32-1/4"	18-1/4" X 30-3/4"	18-3/4" X 31-3/8"	24" x 33-1/4"	14-3/4" x 25-1/2"	SS1300
ES100	17-1/2" X 30-3/4"	16" X 29-1/8"	16-5/8" X 29-3/16"	21-7/8" x 32"	12-1/4" x 23-3/8"	SS1100



LOG ON TO crlaurence.com FOR BUSINESS-TO-BUSINESS SERVICES

A456 | PHONE (800) 421-6144 | FAX (800) 262-3299 TOLL FREE FROM ANYWHERE IN THE U.S.A. OR CANADA

CRL Permanent Mount Wind Deflectors

- Made from High Quality Acrylic with Smoke Finish
- Aerodynamically Stable at Highway Speeds
- Available in Five Sizes



PERMANENT MOUNT WIND DEFLECTORS

CAT.NO.	TYPICAL APPLICATION
XD30SA	Up To 30" Wide Sunroofs
XD32SA	Up To 32" Wide Sunroofs
XD33SA	Up To 33" Wide Sunroofs
XD35SA	Up To 35" Wide Sunroofs
XD38SA	Up To 38" Wide Sunroofs

All Deflector sizes can be combined for quantity pricing.

All SFC/CRL Sunroofs offer the opportunity to open your roof up to sun and fun. Add a Wind Deflector to your sunroof to complete the open-air experience. Permanent Mount Wind Deflectors reduce noise and turbulence. If it's the look of a factory sunroof, or the style and function of pop-up or electric spoiler sunroof, SFC/CRL Wind Deflectors will suit your needs.

CRL Deluxe Sunroof Storage Bags

- Protects Glass Panel When Removed from Frame
- Made from Heavy-Duty Black Vinyl with Padded Lining Plus Hook and Loop Tabs

All SFC/CRL Sunroofs offer removable glass panels. Don't let the worry of scratches and scuffs keep you from an open air experience. Our Deluxe Sunroof Storage Bags are the perfect way to protect the glass panel when you remove it from the frame.

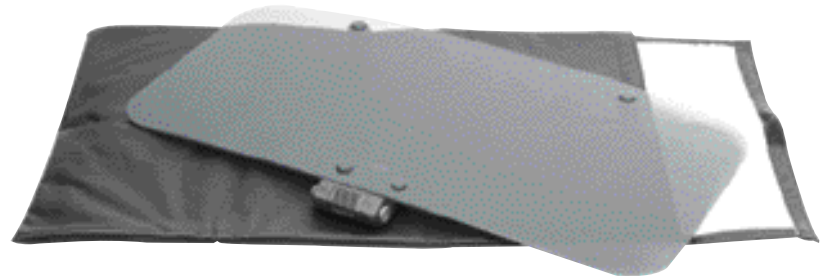

DELUXE SUNROOF STORAGE BAGS

CAT.NO.	FITS GLASS APPLICATION
XB1000	15" x 30"
XB1001	14" x 32", 15" x 30", 17" x 32", 18" x 28", 20" x 32"
XB1004	14" x 33", 16" x 36", 17" x 35", 22" x 38", His 'N Hers

All sizes can be combined for quantity pricing.

Trim Rings for NewPort, AutoPort, and His 'N Hers Sunroofs

Our engineers have designed all SFC/CRL Sunroofs with features that allow you to tuck the fabric into the frame for that OEM look. That makes them easy to install, and the results will please even your most demanding customers. For trim ring application assistance, call the SFC/CRL Auto Tech Center at (800) SFC-ROOF, and ask for Ext. 7780.

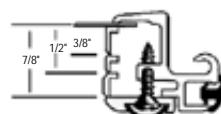

Standard



Peeled

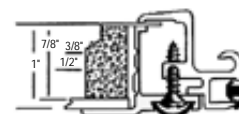

Molded Trim

Speeds and simplifies installation on hard or thick molded headliners. Allows further flexibility with installation approach.

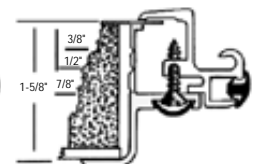

Van Trim

New "modified" Van Trim Ring for deep headliners or panels. Features metal-to-metal contact, eliminating the need for blocking.

Universal Trim

Universal Trim Ring with multiple peel away options allows highest degree of installation flexibility.

CRL Interior Light for the ES Series Electric Spoiler Sunroof

- Can Be Retro-Fit Into Existing ES Series Sunroofs
- Built-In Switch for Convenient Operation
- Factory Finished Appearance

This Electric Dome Light fits our ES Series Electric Spoiler Sunroofs, and can be added during or after the installation is completed. Easy installation incorporates a built-in switch for convenience of operation, and is integrated into the inner trim for a factory-finished appearance.

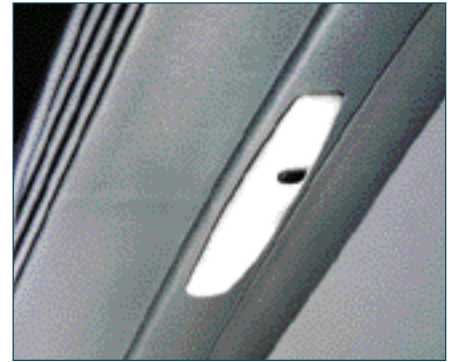
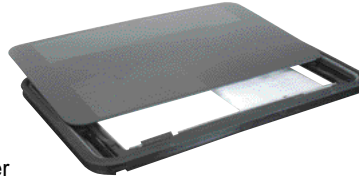

CAT. NO. RM175

CRL Retractable Screen Sunshades

- Attractive Charcoal Screen Reduces Interior Heat
- Rolls Behind the Sunroof Shroud When Open
- Installs Easily

CRL Retractable Screen Sunshades are the perfect match to our ES100 and ES300 Electric Spoiler Sunroofs, and are "out of sight" when not in use. Sold only in pairs.



CAT. NO.	DESCRIPTION
SS1100	Retractable Screen Sunshade for 18" x 31" ES100 Sunroof
SS1300	Retractable Screen Sunshade for 20" x 32" ES300 Sunroof

SFC/CRL Sunshades for Genesis Sunroofs

- Smooth Contoured Surface
- Easy to Detach with Spring Loaded Latch

Genesis Sunshades are manufactured specifically to match our Genesis Sunroof, and can be re-covered to match the interior of the vehicle.

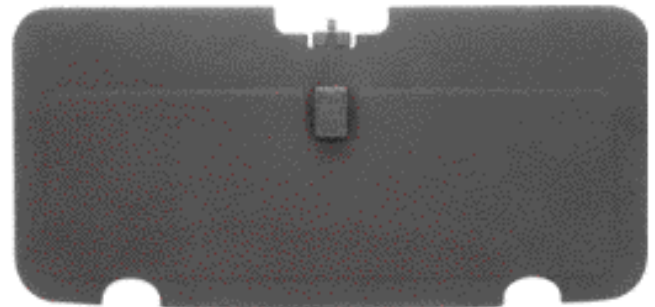

CAT. NO.	DESCRIPTION
SS1528GS	Genesis 15" x 28" Sunshade
SS1732GS	Genesis 17" x 32" Sunshade
SS2032GS	Genesis 20" x 32" Sunshade

SFC/CRL Cool Shades for NewPort and AutoPort Sunroofs

- Vacuum Formed ABS Plastic Can Be Painted to Match Vehicle Interior
- Keeps Interior Cooler

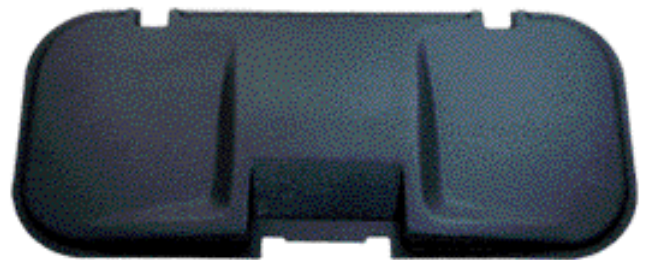

CAT. NO.	COLOR	DESCRIPTION
XS1432B	Black	14" x 32" NewPort Cool Shade
XS1432G	Gray	14" x 32" NewPort Cool Shade
XS1432T	Tan	14" x 32" NewPort Cool Shade
XS1433B	Black	14" x 33" AutoPort Cool Shade
XS1530G	Gray	15" x 30" AutoPort Cool Shade
XS1735B	Black	17" x 35" AutoPort Cool Shade



CRL Electric Kett Power Shears

- Produce Smooth, Even Cuts
- Ideal for Sunroof Installation or Duct Work
- Cuts Up to 180" Per Minute



CAT. NO. K200

For more information on this tool, see page A384.

CRL Power Inline Metal Shear

- Fast, Easy Cutting of Up to 19 Gauge Mild Steel, 24 Gauge Stainless Steel, and 18 Gauge Aluminum



CAT. NO. SD5

For more information on this tool, see page A384.

CRL Heavy-Duty Air Nibbler

- Cuts Up to 18 Gauge Metal
- Efficient and Powerful
- Easy to Operate and Control



CAT. NO. AK80T00L

For more information on this tool, see page A382.

CRL Bosch Unishear

- A Super Tool for Sunroof Cut-Outs
- Cuts Up to 14 Gauge Metal at 5,000 Strokes Per Minute
- Cuts Aluminum, Mild and Stainless Steel Quickly and Efficiently



CAT. NO. B1500

For more information on this tool, see page A384.

CRL Sunroof Professional Installation Templates

- Speeds Installations of SFC/CRL Sunroofs
- Neoprene Exterior Templates Won't Scratch Vehicle Paint

CAT. NO.	TEMPLATE FOR
XT1433	14" x 33" AutoPort
XT1530	15" x 30" AutoPort
XT1732	17" x 32" NewPort
XT1735	17" x 35" AutoPort
XT1828	18" x 28" NewPort
XT2032	20" x 32" NewPort
XT2238	22" x 38" NewPort
XT1528GS	15" x 28" Genesis
XT1732GS	17" x 32" Genesis
XT2032GS	20" x 32" Genesis
XT1717	17" x 17" His 'N Hers



This CRL Professional Installation Template speeds your installation times and provides you with a professional tool that will last for years. Sturdy ABS plastic interior template allows you to quickly locate the perfect position for the sunroof fit on the headliner. The reinforced neoprene exterior template will never scratch the painted surface of the vehicle and remains dimensionally stable.

CRL Sunroof Installation Foam Blocks

- The Professional Way to Block Between Roof Panel and Headliner



CRL Sunroof Installation Foam Blocks will provide you with an easier installation and professional results. Industry installer preferred material for blocking out between the roof panel and the headliner. Dense foam material compresses for a tight fit.

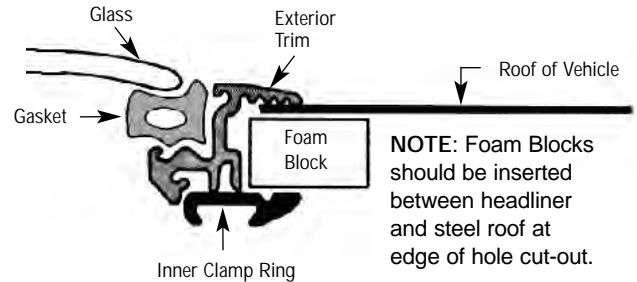
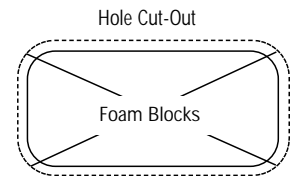

NOTE: Foam Blocks should be inserted between headliner and steel roof at edge of hole cut-out.

CAT. NO.	LENGTH	HEIGHT	THICKNESS	QTY/PKG
RM100	15" (381 mm)	5/8" (16 mm)	13/16" (20 mm)	15

CRL/SFC Sunroof Installation Service Kits

- Screws Sized for Sunroof Installations
- Screw Cover Provides OEM Finish
- Sealant Tape Supplied



Our Sunroof Installation Kits will provide you with an easier installation and the parts to do a professional job.

CAT. NO.	DESCRIPTION
RM160	NewPort/AutoPort Kit
RM600	Genesis Kit

CRL 44NC Neutral Cure Automotive Silicone Sealant

- Low Odor, Non-Acetic Cure Formula
- Non-Corrosive
- Sets Up Fast



CAT. NO. 44NC
10.3 Fl. Oz. (305 ml) Cartridge
30 Cartridges per Case

CRL 44NC Neutral Cure Automotive Silicone is a fast curing, neutral cure silicone with special adhesion additives for use in vehicles to seal and weatherproof. It stops leaks while cushioning the glass against shock and vibration. For more information, see page A129.

CRL Sunroof Butyl Sealant Tape

- Provides Watertight Seal
- One Roll Will Seal Sunroofs Up to 22" x 38"



CAT. NO. RM140

Our Sunroof Butyl Sealant Tape offers a watertight, gasket-like seal, and is recommended for installing aftermarket sunroofs. This tape offers outstanding resistance to weathering, and develops good adhesion to glass, metal, and most other surfaces. The tape is UV stable, non-permeable to gasses and moisture, and has a limited cold flow under load.

CRL Electric Spoiler Sunroof Interior Bezel Spray Paint

- Easy Application Interior Trim Paint and Primer Specifically for Our Electric Spoiler Sunroofs



CAT. NO.	COLOR
RM615	Tan
RM616	Black
RM617	Primer

Net Wt. 6 Oz. (170 g)



LOG ON TO crlaurence.com FOR BUSINESS-TO-BUSINESS SERVICES

A460 | PHONE (800) 421-6144 | FAX (800) 262-3299 TOLL FREE FROM ANYWHERE IN THE U.S.A. OR CANADA

AutoPort Replacement Glass

- Quick and Easy Replacement
- Available With or Without Hardware

SFC/CRL Sunroof Replacement Glass is built to the same tolerances of the original glass. You will get a perfect fit on AutoPort Sunroofs manufactured from 1989 to current production.

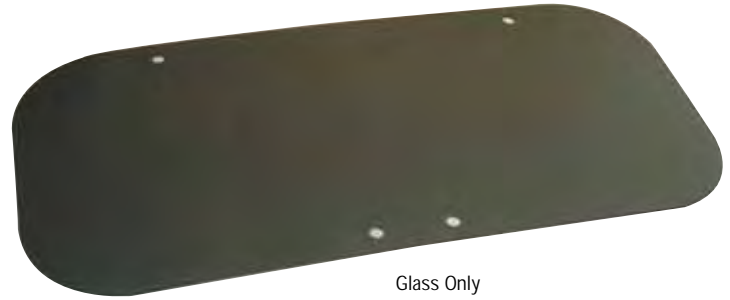

Glass Only

CAT. NO.	DESCRIPTION	FITS SUNROOF SIZES
RG310H	Hi-Performance Glass Only	15" x 30"
RG310HH	Hi-Performance Glass with Hardware	15" x 30"
RG320H	Hi-Performance Glass Only	17" x 35"
RG320HH	Hi-Performance Glass with Hardware	17" x 35"

AutoPort Replacement Handle

- Complete Handle Assembly
- Original Part Replacement



CAT. NO. RL110

Replacement of post-1989 AutoPort Handles is just as simple as removing and replacing the screws held by the outside button nuts. When ordering please specify the type of latch used in the original glass.

AutoPort Hardware Kit

- Complete Handle and Hinge Package
- Manufactured to Original Tolerances



CAT. NO. RH110

AutoPort Hardware Kits are suitable for all AutoPort Sunroofs manufactured from 1989 to current. Contains all the necessary components to easily replace worn parts.

AutoPort Replacement Hinges

- Complete Hinge Assembly
- Simple to Assemble



CAT. NO. RH140

Replacement of AutoPort Hinges is a snap. Simply align the grommet to the glass hole and screw components together with Threadlocker provided in the kit.

AutoPort Replacement Gaskets

- 100% Extruded Silicone
- Resists All Weather Conditions



CAT. NO.	FITS SUNROOF SIZES
RS200SFC	14" x 33"
RS210	15" x 30"
RS220	17" x 35"

Newport Replacement Glass

- Quick and Easy Replacement
- Available With or Without Hardware



Glass with Hardware

CAT. NO.	DESCRIPTION	FITS SUNROOF SIZES
RG350H	Hi-Performance Glass Only	14" x 32"
RG350HH	Hi-Performance Glass with Hardware	14" x 32"
RG350HHA	Hi-Performance Glass with RL110 Latch and Hardware	14" x 32"
RG410H	Hi-Performance Glass Only	16" x 36"
RG410HH	Hi-Performance Glass with Hardware	16" x 36"
RG360H	Hi-Performance Glass Only	17" x 32"
RG360HH	Hi-Performance Glass with Hardware	17" x 32"
RG360HHA	Hi-Performance Glass with RL110 Latch and Hardware	17" x 32"
RG390H	Hi-Performance Glass Only	18" x 28"
RG390HH	Hi-Performance Glass with Hardware	18" x 28"
RG400HD	Hi-Performance Glass Only*	18" x 28"
RG400HDH	Hi-Performance Glass with Hardware*	18" x 28"
RG370H	Hi-Performance Glass Only	20" x 32"
RG370HH	Hi-Performance Glass with Hardware	20" x 32"
RG380H	Hi-Performance Glass Only	22" x 38"
RG380HH	Hi-Performance Glass with Hardware	22" x 38"

* Dual Contour Models

SFC/CRL Sunroof Replacement Glass is built to the same tolerances as the original glass. You will get a perfect fit on NewPort Sunroofs manufactured from 1989 to current production. When ordering replacement glass with hardware on sunroof sizes 14" x 32" and 17" x 32" please note the type of rear latch the original sunroof had. All Newport Sunroofs of these two sizes built from 1989 to 1995 have a Cat. No. RL110 Open Handle. All Sunroofs built from 1996 to current production have a Cat. No. RL105 Handle.

NewPort Replacement Handles

- Complete Handle Assembly
- Original Part Replacement



CAT. NO. RL110



CAT. NO. RL105

Replacement of a post-1989 NewPort Handle is just as simple as removing and replacing the screws held by the outside button nuts. When ordering please specify the type of latch used in the original glass.

NewPort Hardware Kits

- Complete Handle and Hinge Package



CAT. NO. RH110
Pre-1995 Models
14" x 32" and 17" x 32"



CAT. NO. RH100
Models from 1996
to Current, All Sizes

Newport Hardware Kits are intended for all NewPort Sunroofs manufactured from 1989 to current production. Kits contain all the necessary components to easily replace worn parts.

NewPort Replacement Hinges

- Simple Assembly Replacement
- No Adjustments Necessary



CAT. NO. RH140

Replacement of post-1989 NewPort Hinges is a snap. Simply align the grommet to the glass hole and screw components together with Threadlocker provided in the kit.

NewPort Replacement Gaskets

- 100% Extruded Silicone
- Resists All Weather Conditions



CAT. NO.	FITS SUNROOF SIZES
RS260	14" x 32"
RS310	16" x 36"
RS270	17" x 32"
RS300	18" x 28"
RS280	20" x 32"
RS290	22" x 38"



Genesis Replacement Glass

- Comes with Hardware Assembled to Hi-Performance Solar Glass



Replacement Hi-Performance Solar Glass for the SFC/CRL Genesis Sunroof comes with pre-assembled hardware installed. Just select from the three available Genesis sizes shown at left for a perfect fit.

CAT. NO.	DESCRIPTION	FITS SUNROOF SIZES
RG620HH	Hi-Performance Glass with Hardware	15" x 28"
RG610HH	Hi-Performance Glass with Hardware	17" x 32"
RG600HH	Hi-Performance Glass with Hardware	20" x 32"

Genesis Replacement Handle

- Complete Handle Assembly to Replace Original
- Assembles to Glass Bracket

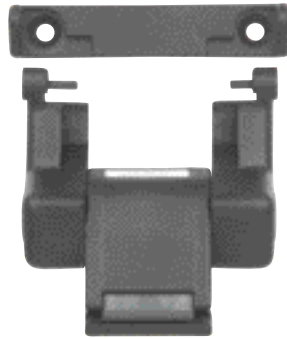

Replacement of a Genesis Handle is just as simple as removing and replacing the main body of the latch using the knurled pins provided.

CAT. NO. RL105

Genesis Replacement Gaskets

- 100% Extruded Silicone
- Resists All Weather Conditions

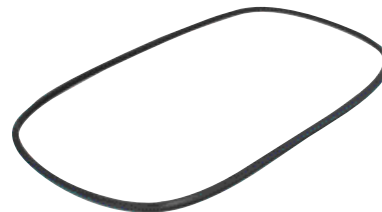

CAT. NO.	FITS SUNROOF SIZES
RS620	15" x 28"
RS610	17" x 32"
RS600	20" x 32"

His 'N Hers Replacement Glass

- Complete with Hardware

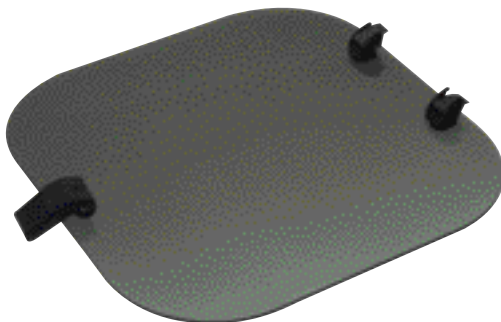

CAT. NO. RG330HH

SFC/CRL Sunroof Replacement Glass is built to the same tolerances of the original glass. You will get a perfect fit on His 'N Hers Sunroofs manufactured from 1989 to current production.

His 'N Hers Hardware Kit

- Manufactured to Original Tolerances
- Easy Bolt-Off/Bolt-On



CAT. NO. RH120

His 'N Hers Hardware Kits are direct replacements for all His 'N Hers Sunroofs manufactured from 1989 to current production. Kit contains all of the necessary components to easily replace worn parts.

His 'N Hers Replacement Latch

- Simple to Replace
- Bolt-Off/Bolt-On to Original Glass

Replaces Latch for His 'N Hers Sunroofs manufactured from 1989 to current production.



CAT. NO. RL120

His 'N Hers Replacement Gasket

- Resists All Weather Conditions
- 100% Extruded Silicone

CAT. NO. RS250



Electric Spoiler Replacement Glass

- Solar High Performance Glass for 18" x 31" and 20" x 32" Sizes
- Quick and Easy Replacement

Replacement Glass for the Electric Spoiler Sunroof is built to the exact tolerances used on Westmont, Topline, Meritor, and our current models of the ES100, ES300, and ES500 Electric Spoiler Sunroof. Glass comes with bracket attachments for easy retrofit.



CAT. NO.	DESCRIPTION	FITS SUNROOF SIZES
RG641HH	Hi-Performance Glass with Hardware	18" x 31" ES100
RG640HH	Hi-Performance Glass with Hardware	20" x 32" ES300/ES500

Electric Spoiler Motor Assembly

- Fits ES100, ES300, and ES500 Models

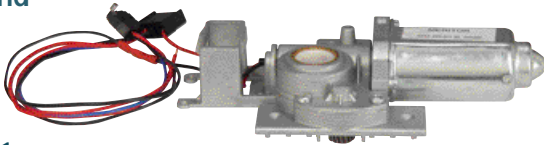

CAT. NO. RM621

Electric Spoiler Rocker Switch

- Fits ES100, ES300, and ES500 Models



CAT. NO. RM629

Electric Spoiler Interior Bezel

- Specific Sizes to Fit ES100, ES300, and ES500 Models



CAT. NO.	FITS SUNROOF SIZES
RM626	18" x 31" ES100
RM625	20" x 32" ES300
RM624	20" x 32" ES500

Electric Spoiler Replacement Gaskets

- Specific Sizes to Fit ES100, ES300, and ES500 Models



CAT. NO.	FITS SUNROOF SIZES
RS510	18" x 31" ES100
RS535	20" x 32" ES300/ES500

Electric Spoiler Sunshades

Please see page A458 for complete details on our Retractable Sunshades.



CAT. NO.	FITS SUNROOF SIZES
SS1100	18" x 31" ES100
SS1300	20" x 32" ES300

Electric Spoiler Repair Components

Repair parts are available to keep your customer's Electric Spoiler Sunroofs looking good and operating smoothly.

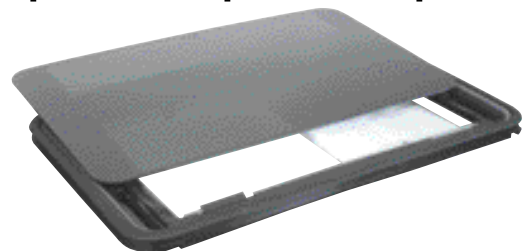

Replaceable components include: Clamp Rings, Cable Guides, Rail Assemblies, and Variolite® Sunshade Slats. Appearance accessories include Primers and Spray Paint for the Interior Bezel. See them at crlaurence.com by entering 'Spoiler' in the Product Search Box.



CRL Replacement Parts for Older Model and Out-of-Production Sunroofs

- An Extensive Selection of Glass, Gaskets, Hinges, Handles, and Brackets for Many Brands of Sunroofs
- crlaurence.com Has Many Hard-To-Find Parts Available From No Other Source

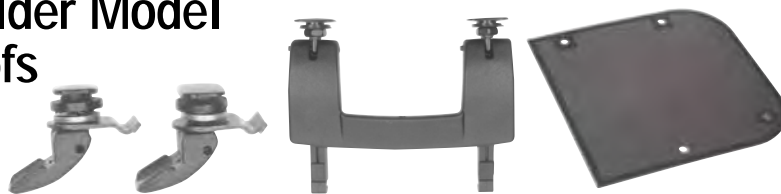

The place to go for Sunroof Replacement parts is crlaurence.com. It's your source for dozens of hard-to-find replacement parts for many brands of older model and out-of-production sunroofs installed over the past 20+ years. See the information below on how to search for specific parts.

CRL Replacement Hinges and Handles

- All the Right Parts to Keep the Glass Shut Securely

We have Sunroof Hinges and Handles to fit many older model sunroofs. All replacement parts are made to the same exact tolerances as the original part so you will get an exact fit. Go to crlaurence.com and enter SUNROOF HINGE in the Product Search Box to begin your search.

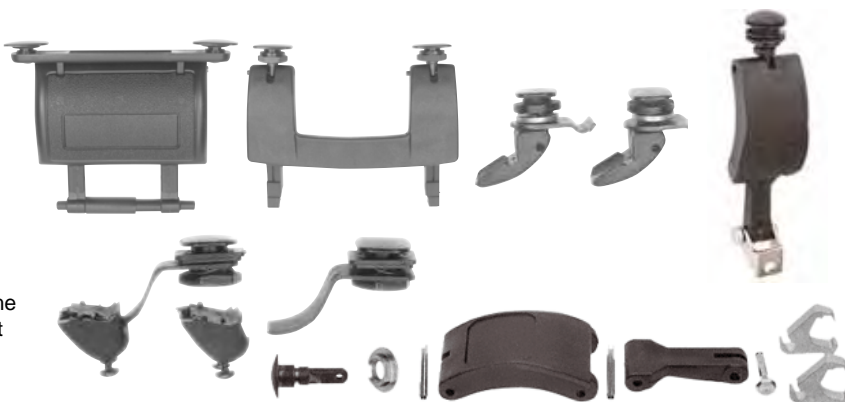

CRL Replacement Gaskets

CRL has Replacement Gaskets to fit many older model sunroofs. All are made to the same exact tolerances as the original gasket so you will get a tight fit. Go to crlaurence.com and enter SUNROOF GASKET in the Product Search Box to begin your search.



CRL Replacement Glass



Sunroof Replacement Glass to fit older model and out-of-production sunroofs is still available from CRL. Most are original pieces from the same sunroof manufacturers, so you can be assured of a snug fit. Go to crlaurence.com and enter SUNROOF GLASS in the Product Search Box to begin your search. **NOTE:** Glass is not interchangeable between sunroof manufacturers. See the box at right for guidelines on how to measure for the correct replacement glass for your customer's sunroof.

How to Properly Measure Sunroof Replacement Glass

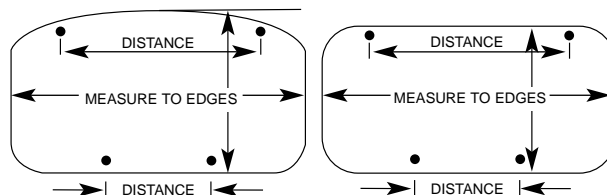

Sunroof Glass Types

- How to Tell the Difference



Solar Hi-Performance

Solar Hi-Performance provides 92% UV protection and does an excellent job of blocking infrared rays.



Reflective

Reflective combines high reflectivity with a ceramic tempered dot pattern to provide outstanding light diffusion and superior insulating qualities.



Black Dot Matrix

Black Dot Matrix has a silkscreen printed, ceramic tempered dot pattern and a 1/2" black border. It provides a high degree of light diffusion and added decorative appeal.



Conversion

CRL "All Glass" and "Conventional"

"All Glass Look" Van Windows are Available for Installation in Rear and Side Doors, Plus Driver and Passenger Side Panel Locations

- Models for Chevy/GMC, Ford, and Dodge Vans
- Match Factory Flush Look
- Contoured to Match Side Walls and Doors

The newest thing in van windows is CRL's "All Glass Look" selections for current model full size vans. They are the perfect accent to aerodynamic van styling, with dark solar glass that goes right to the edge for a flush look. Interior structural framing has a black powder-coat finish, concealed from outside view by the silk screened black fade edge of the glass. The entire unit is contoured to match the side wall or door, making installation as simple as conventional fully framed windows. Our T-Vent Bay Windows feature state-of-the-art operating hardware on the opening panels. Models are available to fit the forward and rear driver and passenger side panels, plus sliding and hinged side or rear doors.

The dimensions shown for our Van Windows are "Cut-Out" sizes at the longest point, side-to-side and top-to-bottom. To determine their outer frame dimensions please refer to the table below.

VAN WINDOW SERIES	OUTER FRAME DIMENSIONS
FWXXXX	Add 1-1/4" to Cut-Out
VW1XXXX	Add 1-1/4" to Cut-Out
VW2XXXX	Add 1-1/4" to Cut-Out
VW3XXXX	Add 1-1/4" to Cut-Out
VW4XXXX	Add 3/4" to Cut-Out
VW5XXXX	Add 3/4" to Cut-Out
VW6XXXX	Add 3/4" to Cut-Out

NOTE: CRL Van Windows are packaged without screws or mounting tape. Please ask for **Cat. No. VW8X34S** Screw Package which contains 25 black color-coded screws, and **Cat. No. 60701** which is a 50 foot roll of 1/2" x 1/4" Foam Mounting Tape.

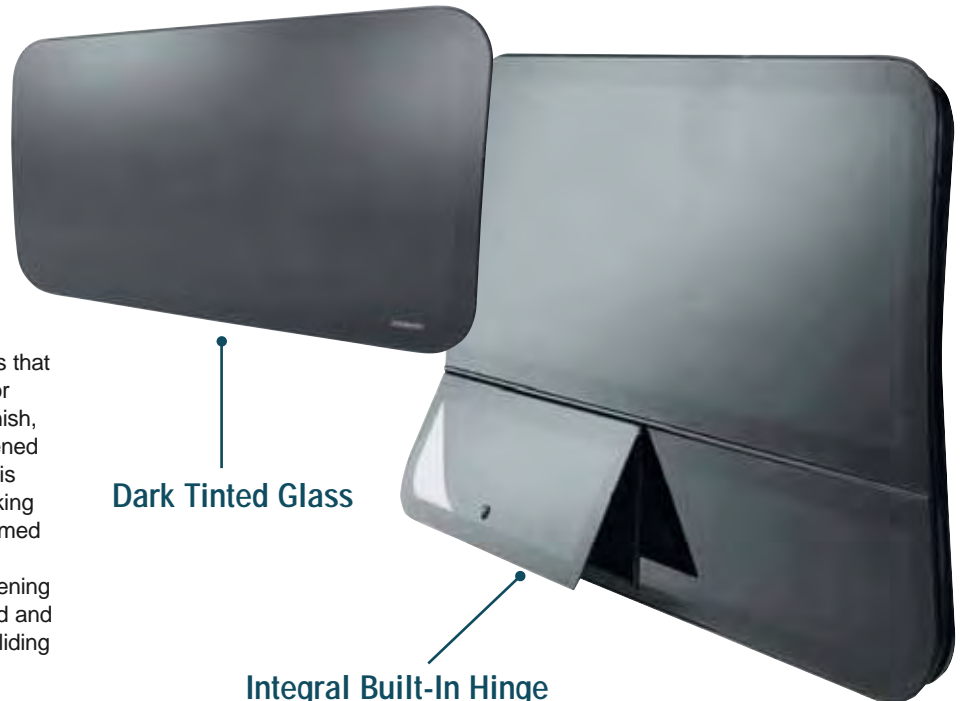

Dark Tinted Glass

Integral Built-In Hinge



Flush-to-the-Edge Glass



CAT. NO. VW8X34S



CAT. NO. 60701



LOG ON TO crlaurence.com FOR BUSINESS-TO-BUSINESS SERVICES

A466 | PHONE (800) 421-6144 | FAX (800) 262-3299 TOLL FREE FROM ANYWHERE IN THE U.S.A. OR CANADA

Window Features



Framed Van Windows

"Conventional" Van Windows Available for Installation in All Door and Panel Locations

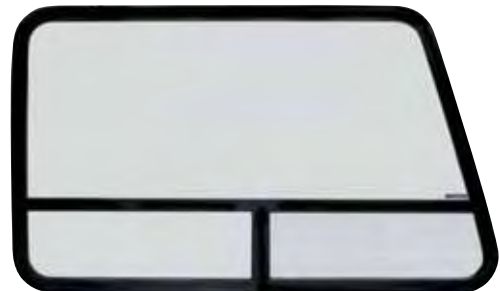

High Quality Paint Finish

We have our own high quality powder-paint line to give our windows years of low maintenance service life without finish failure.



Welded Vinyl Glazing

All windows are manufactured with welded vinyl glazing gaskets that eliminate creep and shrinkage.

Large Selection of Clamp Rings Available

We manufacture clamp rings to fit walls from 1/8" to 2-1/4" thick.



How to Determine Proper Measurements of Van Windows

- Determine Proper Corner Radius
- Determine Proper Width and Height

Because many vans have special window indents in their sheet metal sides it is important that the windows you order will fit within these prescribed areas. Measurements must also accommodate interior structures such as ribs and door frames. The measurements you take are crucial to a proper fit and seal of the windows, so take your time and be precise. The end result will be worth the extra effort. If you have questions on the proper way to take measurements, contact CRL Automotive Technical Sales by e-mail techsales@crlaurence.com.

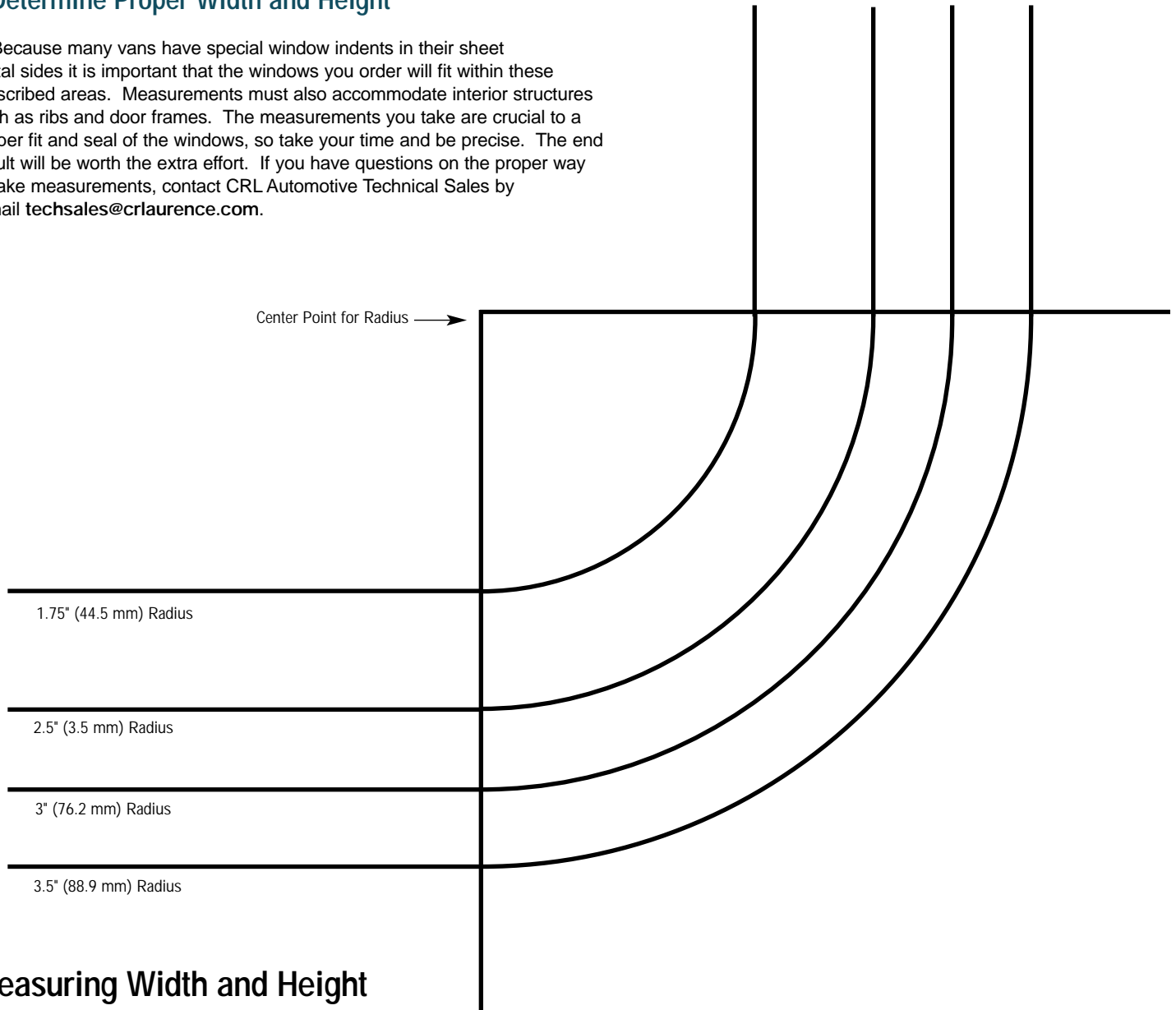

Measuring Width and Height

Always measure straight across at the widest point to the outside of the frame.

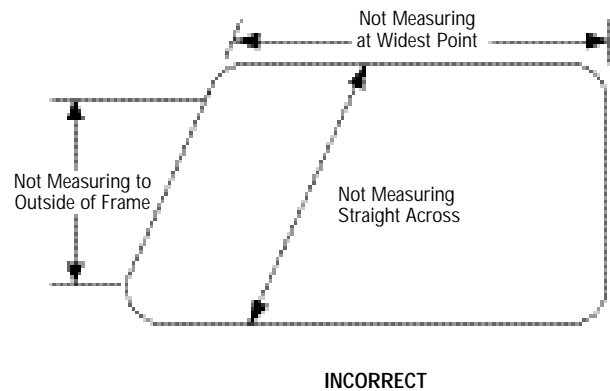
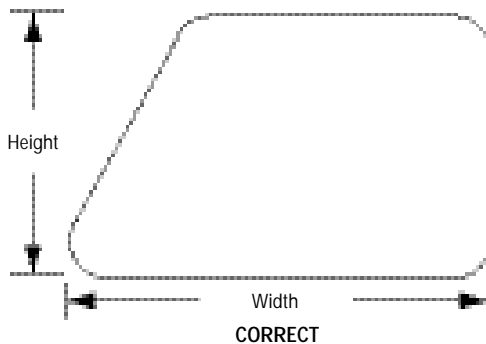

How to Determine Proper Measurements of Van Windows

- Measuring and Designating the Proper Angle Degrees of Van Window Frames

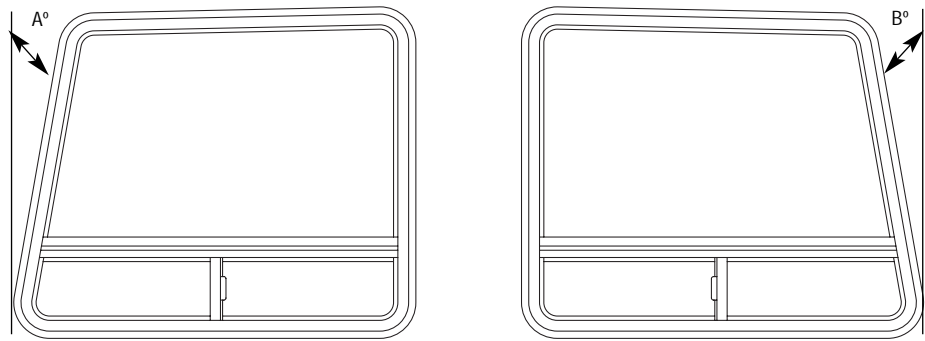

While most van windows are rectangular in shape, many have angled leading or trailing edges to accommodate the shape of the van into which they will be installed. When ordering van windows to either replace existing windows, or for new openings in the van, it is important to determine the angle of the vertical edges.

To simplify this process we refer to an angle on the left side of the window (viewed from the outside) as the "A" Angle. An angle on the right side of the window is called the "B" Angle. This applies to all windows, either driver or passenger side, and should be included in your measurements when ordering windows that are not rectangular.

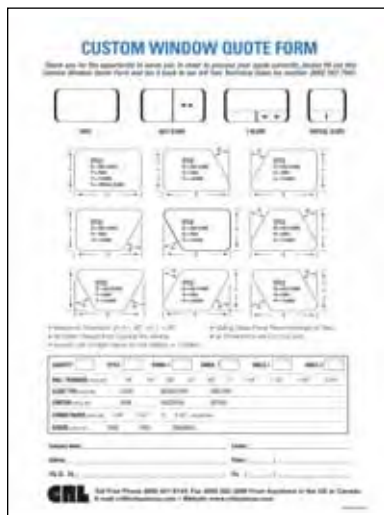
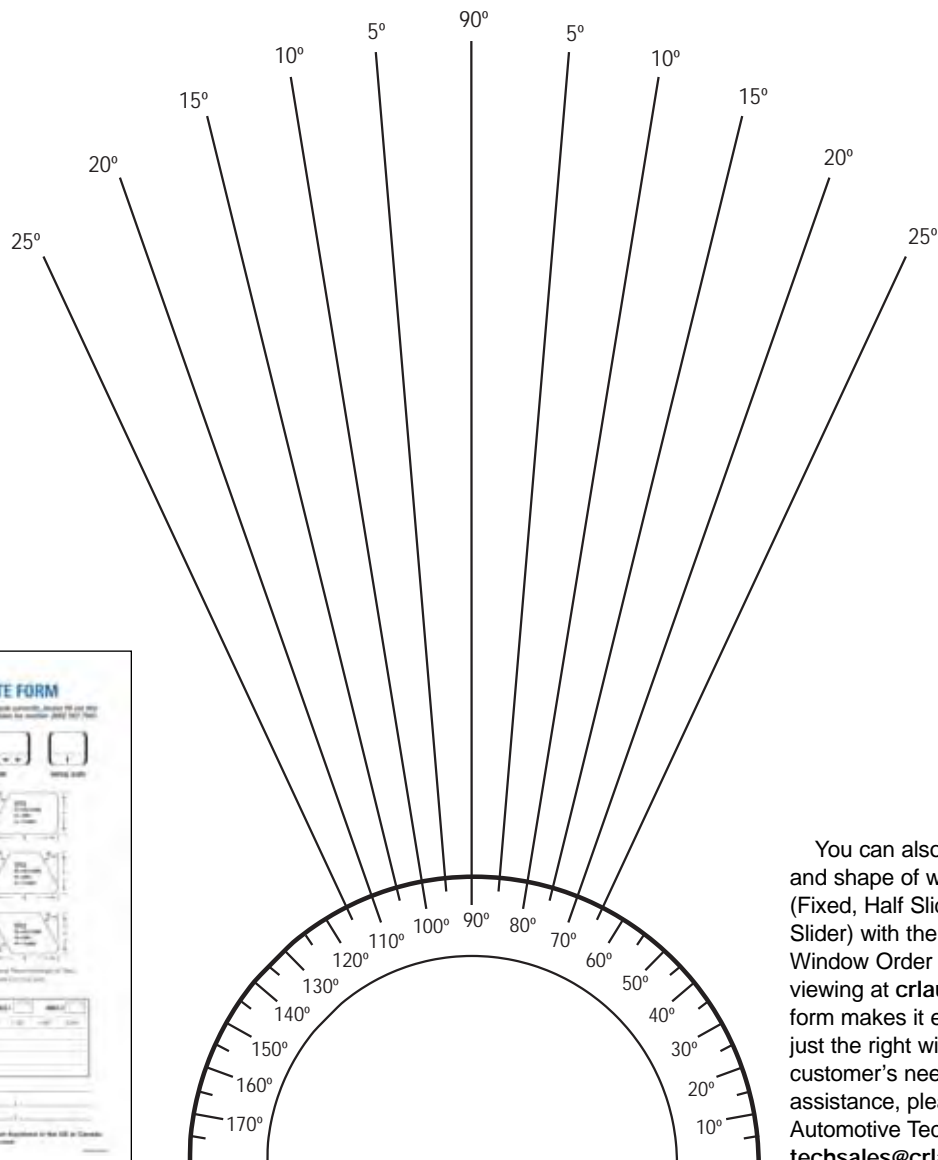

You can also designate the type and shape of window you need (Fixed, Half Slider, T-Slider or Vertical Slider) with the aid of our Custom Window Order Form, available for viewing at crlaurence.com. This form makes it easy for you to select just the right window to meet your customer's needs. For additional assistance, please contact CRL Automotive Technical Sales by e-mail techsales@crlaurence.com.



CRL "All Glass Look" Van Windows Sprinter Vans – Short and Long Wheelbases

new

- High Tech "Aero" Look
- 28% Solar Privacy Glass
- Use OEM Stamping for Cut Line
- Comes with 1/8" Wall Clamp Ring



CRL now has "All Glass Look" Windows for Daimler-Chrysler's new Sprinter Van. They are the perfect accent to complement the Sprinter's aerodynamic styling.

These windows have silk-screened black fade edges with solar privacy glass that goes right to the black powder-coat finished frame edge for a flush look. The entire unit is contoured to match the sidewall or door, making installation as simple as with a conventional fully framed window.

Our Sprinter Van Windows are configured to fit within the OEM stampings and provide a customized OEM look. Whether converting the Sprinter for commercial or recreational use, CRL "All Glass Look" Van Windows are the right choice. All come standard with 1/8" wall clamp rings.

Short Wheelbase Sprinter



Driver's Side Forward and Rear Windows



Passenger's Side Sliding Door and Rear Windows



Rear Door Windows

Long Wheelbase Sprinter



Driver's Side Forward, Middle and Rear Windows



Passenger's Side Sliding Door, Middle and Rear Windows



Rear Door Windows

Short Wheelbase Bay Window Sets

CAT. NO.	TYPE	SIZE (W X H)	STYLE	INSTALLS IN
FW601	T-Vent	41" x 23-1/4"	Rectangle 90° x 90°	Driver's Side Forward
FW606L	T-Vent	70-3/4" x 23-1/4"	Rectangle 90° x 90°	Driver's Side Rear
FW606R	T-Vent	70-3/4" x 23-1/4"	Rectangle 90° x 90°	Passenger's Side Rear

Short Wheelbase Bay Windows

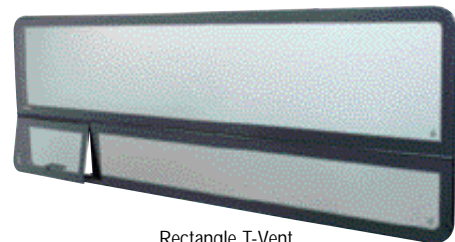

Rectangle T-Vent

Long Wheelbase Bay Window Sets

CAT. NO.	TYPE	SIZE (W X H)	STYLE	INSTALLS IN
FW601	T-Vent	41" x 23-1/4"	Rectangle 90° x 90°	Driver's Side Forward
FW602	T-Vent	51" x 23-1/4"	Rectangle 90° x 90°	Driver's Side Middle
FW602	T-Vent	51" x 23-1/4"	Rectangle 90° x 90°	Driver's Side Rear
FW604	Fixed	41" x 23-1/4"	Rectangle 90° x 90°	Passenger's Side Middle
FW602	T-Vent	51" x 23-1/4"	Rectangle 90° x 90°	Passenger's Side Rear

Long Wheelbase Bay Windows



Rectangle T-Vent

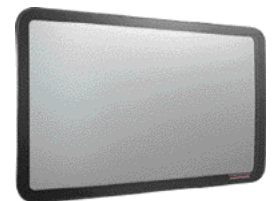

Rectangle Fixed

Fixed Glass Door Windows*

CAT. NO.	TYPE	SIZE (W X H)	STYLE	INSTALLS IN
FW603L	Fixed	23-3/4" x 23-1/4"	Angled 10° x 90°	LH Hinged Rear Door
FW603R	Fixed	23-3/4" x 23-1/4"	Angled 90° x 10°	RH Hinged Rear Door
FW605	Fixed	39-1/4" x 23-1/4"	Rectangle 90° x 90°	Sliding Side Door

* For both short and long wheelbase models.

Fixed Glass Door Windows



Angled



Rectangle



LOG ON TO crlaurence.com FOR BUSINESS-TO-BUSINESS SERVICES

A470 | PHONE (800) 421-6144 | FAX (800) 262-3299 TOLL FREE FROM ANYWHERE IN THE U.S.A. OR CANADA

CRL "All Glass Look" Van Windows Dodge '78 - '02 Full Size Vans

- High Tech "Aero" Look
- Dark Solar Glass
- Silk Screen Frit Edge
- Contoured to Match Van Walls
- Comes with 1/8" or 1" Wall Clamp Ring



CRL offers "The Look" in our "All Glass Look" Van Windows for Dodge full size vans. OEM designs have encouraged our engineers to redesign the conventional van window, resulting in the "All Glass Look". Aluminum frames have durable black powder-coated paint finish. Pop-out vents complete the total package that your customers are demanding. Bay Windows come standard with 1/8" wall clamp rings while the Door Windows have a 1" wall clamp ring.

NOTE: Cut-out dimensions are provided. To determine which window to order for replacement purposes, deduct 1-1/4" from the overall outside frame dimensions of your existing window to determine the cut-out size as shown on this page. All dimensions are taken at the longest point side-to-side and top-to-bottom.

NOTE: Because of their custom fit design, specific model applications are not interchangeable between van manufacturers.

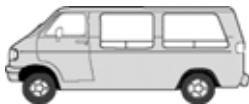

Driver's Side Forward
and Rear Windows



Passenger's Side
Rear Window



Rear Door
Windows



Passenger's Side
Hinged Door Windows



Passenger's Side
Sliding Door Windows

T-Vent Bay Window Sets - 1/8" Wall

CAT. NO.	SIZE (W X H)	STYLE	INSTALLS IN
FW311L	41-1/2" x 28"	Rectangle 90° x 90°	Driver's Side Forward
FW321L	41-1/2" x 28"	Angled 90° x 8°	Driver's Side Rear
FW321R	41-1/2" x 28"	Angled 8° x 90°	Passenger's Side Rear
FW311L	41-1/2" x 28"	Rectangle 90° x 90°	Driver's Side Forward
FW361L	29" x 28"	Angled 90° x 8°	Driver's Side Rear
FW361R	29" x 28"	Angled 8° x 90°	Passenger's Side Rear

T-Vent Bay Windows

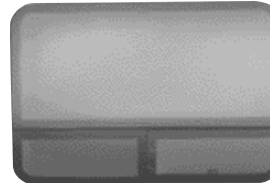

Rectangle

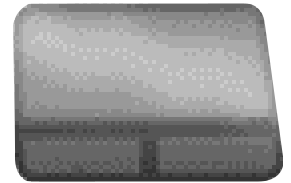

Angled

Fixed Glass Bay Window Sets - 1/8" Wall

CAT. NO.	SIZE (W X H)	STYLE	INSTALLS IN
FW312L	41-1/2" x 28"	Rectangle 90° x 90°	Driver's Side Forward
FW322L	41-1/2" x 28"	Angled 90° x 8°	Driver's Side Rear
FW322R	41-1/2" x 28"	Angled 8° x 90°	Passenger's Side Rear
FW312L	41-1/2" x 28"	Rectangle 90° x 90°	Driver's Side Forward
FW362L	29" x 28"	Angled 90° x 8°	Driver's Side Rear
FW362R	29" x 28"	Angled 8° x 90°	Passenger's Side Rear
FW081L	44" x 27-3/8"	Rectangle 5° x 5°	Driver's Side Forward
FW091L	51-5/8" x 27-3/8"	Angled 5° x 10°	Driver's Side Rear
FW091R	51-5/8" x 27-3/8"	Angled 10° x 5°	Passenger's Side Rear

Fixed Glass Bay Windows

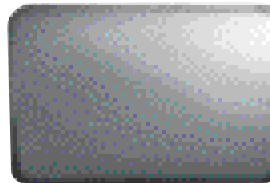

Rectangle



Angled

Fixed Glass Door Windows - 1" Wall

CAT. NO.	SIZE (W X H)	STYLE	INSTALLS IN
FW331	20-1/8" x 17-5/8"	Rectangle 90° x 90°	Hinged Side and Rear Doors
FW371	43-11/16" x 17-5/8"	Rectangle 90° x 90°	Side Sliding Door

Fixed Glass Door Windows

HINGED SIDE AND REAR DOORS

SIDE SLIDING DOORS



Rectangle



Rectangle

CRL Conventional Frame Van Windows Dodge '78 - '02 Full Size Vans



- Dark Gray Tinted Glass
- Some Styles Available with Stainless Accent Strip
- Comes with an 1/8", 1/4", 1" or 2-1/4" Wall Clamp Rings

CRL not only supplies you with state-of-the-art design "All Glass Look" Van Windows, but continues to supply the industry with the conventional framed windows that have been the industry standard for years. There are thousands of these Dodge vans on the road, and they all require a source for replacement windows. CRL is your source.

NOTE: Cut-out dimensions are provided. To determine which window to order for replacement purposes, deduct 1-1/4" from the overall outside frame dimensions of your existing window to determine the cut-out size as shown on this page. All dimensions are taken at the longest point side-to-side and top-to-bottom.

NOTE: Because of their custom fit design, specific model applications are not interchangeable between van manufacturers.

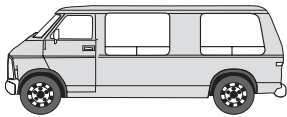

Driver's Side Forward and Rear Windows

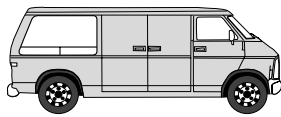

Passenger's Side Rear Window

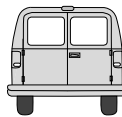

Rear Door Windows

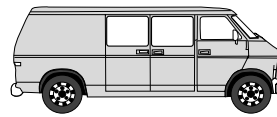

Passenger's Side Hinged Door Windows

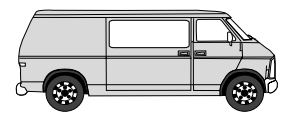

Passenger's Side Sliding Door Windows

T-Slider Bay Window Sets

CAT. NO.	TYPE	SIZE (W X H)	STYLE	WALL	INSTALLS IN
VW21481L	T - Slider	40" x 28-1/8"	Rectangle 90° x 90°	1/8"	Driver's Side Forward
VW21581L	T - Slider	48-1/16" x 28-1/8"	Angled 90° x 17°	1/8"	Driver's Side Rear
VW21581R	T - Slider	48-1/16" x 28-1/8"	Angled 17° x 90°	1/8"	Passenger's Side Rear
VW21201L	T - Slider	29-3/16" x 28-1/4"	Rectangle 90° x 90°	1/8"	Driver's Side Forward
VW21491L	T - Slider	40-1/16" x 28-1/8"	Angled 90° x 17°	1/8"	Driver's Side Rear
VW21491R	T - Slider	40-1/16" x 28-1/8"	Angled 17° x 90°	1/8"	Passenger's Side Rear
VW21471L*	T - Slider	40" x 28-1/8"	Rectangle 90° x 90°	1/8"	Driver's Side Forward
VW21571L*	T - Slider	48-1/16" x 28-1/8"	Angled 90° x 17°	1/8"	Driver's Side Rear
VW21571R*	T - Slider	48-1/16" x 28-1/8"	Angled 17° x 90°	1/8"	Passenger's Side Rear
VW21191L*	T - Slider	29-3/16" x 28-7/16"	Rectangle 90° x 90°	1/8"	Driver's Side Forward
VW21501L*	T - Slider	40-1/16" x 28-1/8"	Angled 90° x 17°	1/8"	Driver's Side Rear
VW21501R*	T - Slider	40-1/16" x 28-1/8"	Angled 17° x 90°	1/8"	Passenger's Side Rear

* Stainless Steel Accent in Black Frame.

T-Slider Bay Windows

BLACK FRAME



Rectangle



Angled

BLACK FRAME WITH STAINLESS ACCENT STRIP

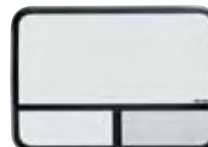

Rectangle

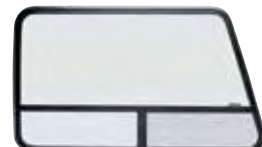

Angled

Hinged Door Windows

CAT. NO.	TYPE	SIZE (W X H)	STYLE	WALL	INSTALLS IN
VW40112	Fixed	20-1/16" x 17-5/8"	Rectangle 90° x 90°	1/4"	Both Rear and Both Side Doors
VW40115	Fixed	20-1/16" x 17-5/8"	Rectangle 90° x 90°	1"	Both Rear and Both Side Doors
VW40119	Fixed	20-1/16" x 17-5/8"	Rectangle 90° x 90°	2-1/4"	Both Rear Doors Only

For the Hinged Side Doors, choose two of either Cat. No. VW40112 or VW40115.
For the Hinged Rear Doors, choose two of Cat. No.'s VW40112, VW40115 or VW40119.
The windows you choose depends on the wall thickness that you want use.

Hinged Door Windows



Rectangle

Sliding Side Door Windows

CAT. NO.	TYPE	SIZE (W X H)	STYLE	WALL	INSTALLS IN
VW40062	Fixed	43-11/16" x 17-5/8"	Rectangle 90° x 90°	1/4"	Sliding Side Door
VW40065	Fixed	43-11/16" x 17-5/8"	Rectangle 90° x 90°	1"	Sliding Side Door
VW60062	Half Slider	43-11/16" x 17-5/8"	Rectangle 90° x 90°	1/4"	Sliding Side Door
VW60065	Half Slider	43-11/16" x 17-5/8"	Rectangle 90° x 90°	1"	Sliding Side Door
VW50065R	T-Slider	43-11/16" x 17-5/8"	Rectangle 90° x 90°	1"	Sliding Side Door

Sliding Side Door Windows

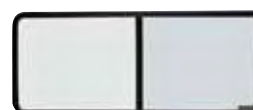

Half Slider

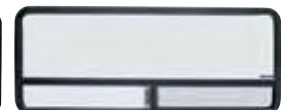

Rectangle

T-Slider



LOG ON TO crlaurence.com FOR BUSINESS-TO-BUSINESS SERVICES

A472 | PHONE (800) 421-6144 | FAX (800) 262-3299 TOLL FREE FROM ANYWHERE IN THE U.S.A. OR CANADA

CRL Conventional Frame Minivan Windows Dodge Caravan and Plymouth Voyager '84 - '95 Minivans

- Fixed, T-Slider and Half Slider Styles
- Dark Gray Tinted Glass
- Powder-Coated Frames



Bay Windows for the '84-'95 Dodge Caravan/Plymouth Voyager are contoured to fit the van perfectly. Our windows increase driver visibility, and provide additional ventilation for passenger comfort. Bay Windows are available in Fixed, T-Slider and Half Slider configurations. All windows come with dark gray tinted glass and black finish frames.

NOTE: Cut-out dimensions are provided. To determine which window to order for replacement purposes, deduct 1-1/4" from the overall outside frame dimensions of your existing window to determine the cut-out size as shown on this page. All dimensions are taken at the longest point side-to-side and top-to-bottom.

NOTE: Because of their custom fit design, specific model applications are not interchangeable between van manufacturers.

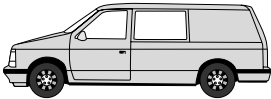

Driver's Side
Forward Window

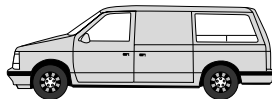

Driver's Side
Rear Window

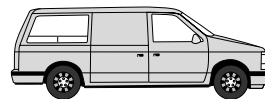

Passenger's Side
Rear Window

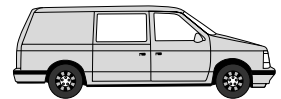

Passenger's Side
Sliding Door Window

Bay Window Sets

CAT. NO.	TYPE	SIZE (W X H)	STYLE	WALL	INSTALLS IN
VW40239L	Fixed	33-3/16" x 17-1/8"	Angled 90° x 3°	2-1/4"	Driver's Side Forward
VW11001L	Fixed	24-13/16" x 16-3/4"	Angled 15° x 23°	1/8"	Driver's Side Rear
VW11001R	Fixed	24-13/16" x 16-3/4"	Angled 23° x 15°	1/8"	Passenger's Side Rear
VW40239L	Fixed	33-3/16" x 17-1/8"	Angled 90° x 3°	2-1/4"	Driver's Side Forward
VW21281L	T-Slider	33-1/8" x 16-3/4"	Angled 90° x 17°	1/8"	Driver's Side Rear
VW21281R	T-Slider	33-1/8" x 16-3/4"	Angled 17° x 90°	1/8"	Passenger's Side Rear
VW60239L	Half Slider	33-3/16" x 17-1/8"	Angled 90° x 3°	2-1/4"	Driver's Side Forward
VW11001L	Fixed	24-13/16" x 16-3/4"	Angled 15° x 23°	1/8"	Driver's Side Rear
VW11001R	Fixed	24-13/16" x 16-3/4"	Angled 23° x 15°	1/8"	Passenger's Side Rear
VW60239L	Half Slider	33-3/16" x 17-1/8"	Angled 90° x 3°	2-1/4"	Driver's Side Forward
VW21281L	T-Slider	33-1/8" x 16-3/4"	Angled 90° x 17°	1/8"	Driver's Side Rear
VW21281R	T-Slider	33-1/8" x 16-3/4"	Angled 17° x 90°	1/8"	Passenger's Side Rear

Bay Windows

BLACK FRAME



Fixed



Half Slider

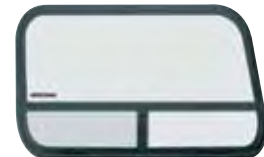

T-Slider

Sliding Side Door Windows

CAT. NO.	TYPE	SIZE (W X H)	STYLE	WALL	INSTALLS IN
VW40235R	Fixed	33-3/16" x 17-1/8"	Angled 3° x 90°	1"	Sliding Side Door
VW60235R	Half Slider	33-3/16" x 17-1/8"	Angled 3° x 90°	1"	Sliding Side Door

Sliding Side Door Windows



Half Slider

CRL "All Glass Look" Van Windows '92+ Ford Full Size Vans

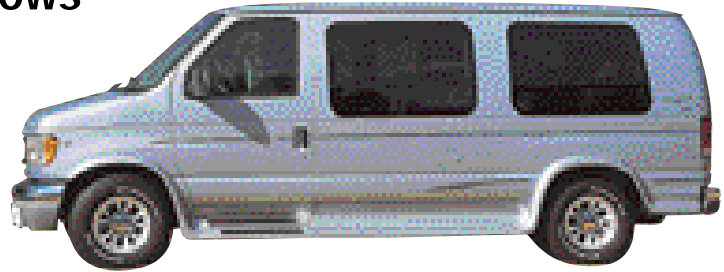

- High Tech "Aero" Look
- Dark Solar Glass
- Silk Screen Frit Edge
- Contoured to Match Van Walls
- Comes with 1/8" Wall Clamp Ring

CRL has "All Glass Look" Van Windows for '92+ Ford Vans. These windows offer the "Aero" design features now being used by OEM's: clean sight lines, reglazable panels, and narrow frame exposures to the exterior. All opening vents have pop-out latches. All come standard with 1/8" wall clamp rings.

NOTE: Cut-out dimensions are provided. To determine which window to order for replacement purposes, deduct 1-1/4" from the overall outside frame dimensions of your existing window to determine the cut-out size as shown on this page. All dimensions are taken at the longest point side-to-side and top-to-bottom.

NOTE: Because of their custom fit design, specific model applications are not interchangeable between van manufacturers.

NOTE: In vans with sliding doors it is recommended to measure the height of the sliding door mechanism to make sure the sidewall will accept the window being ordered. Measure from 2" below the drip rail to approximately 2" above the sliding door track mechanism.



Driver's Side Forward and Rear Windows



Passenger's Side Rear Window



Rear Door Windows



Passenger's Side Hinged Door Windows



Passenger's Side Sliding Door Windows

T-Vent Bay Window Sets

CAT. NO.	SIZE (W X H)	STYLE	INSTALLS IN
FW211L	41-1/2" x 27"	Angled 3° x 90°	Driver's Side Forward
FW221L	41-1/2" x 26-5/8"	Angled 90° x 12°	Driver's Side Rear
FW221R	41-1/2" x 26-5/8"	Angled 12° x 90°	Passenger's Side Rear
FW411L	42-5/8" x 27-3/8"	Rectangle 90° x 90°	Driver's Side Forward
FW421L	42-5/8" x 27-3/8"	Angled 90° x 7°	Driver's Side Rear
FW421R	42-5/8" x 27-3/8"	Angled 7° x 90°	Passenger's Side Rear
FW011L	40-5/16" x 26-3/4"	Angled 90° x 2°	Driver's Side Forward
FW021L	37-1/16" x 26-5/16"	Angled 2° x 4°	Driver's Side Rear
FW021R	37-1/16" x 26-5/16"	Angled 4° x 90°	Passenger's Side Rear
FW031L	41-1/4" x 25-7/8"	Angled 4° x 2°	Driver's Side Forward
FW041L	40" x 25-3/8"	Angled 2° x 4°	Driver's Side Rear
FW041R	40" x 25-3/8"	Angled 4° x 2°	Passenger's Side Rear

T-Vent Bay Windows

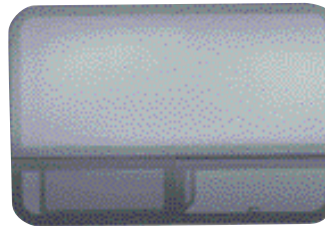

Rectangle

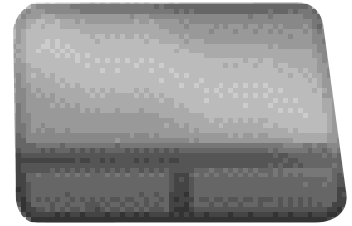

Angled

Fixed Glass Bay Window Sets

CAT. NO.	SIZE (W X H)	STYLE	INSTALLS IN
FW212L	41-1/2" x 27"	Rectangle 3° x 90°	Driver's Side Forward
FW222L	41-1/2" x 26-5/8"	Angled 90° x 12°	Driver's Side Rear
FW222R	41-1/2" x 26-5/8"	Angled 12° x 90°	Passenger's Side Rear
FW412L	42-5/8" x 27-3/8"	Rectangle 90° x 90°	Driver's Side Forward
FW422L	42-5/8" x 27-3/8"	Angled 90° x 7°	Driver's Side Rear
FW422R	42-5/8" x 27-3/8"	Angled 7° x 90°	Passenger's Side Rear

Fixed Glass Bay Windows



Rectangle



Angled

Fixed Glass Door Windows

CAT. NO.	SIZE (W X H)	STYLE	INSTALLS IN
FW231	14" x 20-1/2"	Rectangle 90° x 90°	40% Hinged Side Door
FW241	18-13/16" x 20-1/2"	Angled 90° x 4°	60% Hinged Side Door
FW251	22-3/16" x 18-5/8"	Angled 6° x 90°	LH Hinged Rear Door
FW261	20-7/16" x 18-5/8"	Angled 90° x 6°	RH Hinged Rear Door
FW271	40-3/8" x 20-1/2"	Angled 90° x 3°	Sliding Side Door

SLIDING SIDE DOOR

HINGED REAR DOORS



Rectangle

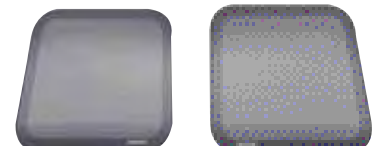

Angled



LOG ON TO crlaurence.com FOR BUSINESS-TO-BUSINESS SERVICES

A474 | PHONE (800) 421-6144 | FAX (800) 262-3299 TOLL FREE FROM ANYWHERE IN THE U.S.A. OR CANADA

CRL Conventional Frame Van Windows Ford '92+ Full Size Vans

- T-Slider Bay Windows are Screened
- Bay Windows have Dark Gray or Bronze Tint Glass
- Some Styles Available with Stainless Accent Strip
- Comes with 1/8", 1/4" or 1/2" Wall Clamp Rings



In 1992, Ford changed the body lines of full size vans to include a sloping roof line which enabled C.R. Laurence to design windows with more angles, providing a more attractive appearance.

All windows are available with dark gray glass, some models with solar bronze reflective glass for that "limo" look. All have black finish frames, and some are available with the stainless accent strip.

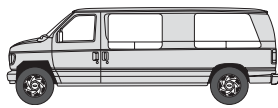

Driver's Side Forward and Rear Windows

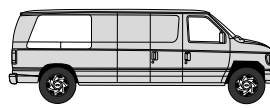

Passenger's Side Rear Window



Rear Door Windows

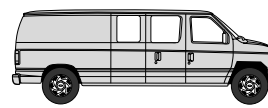

Passenger's Side Hinged Door Windows

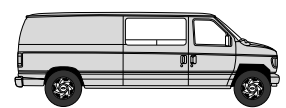

Passenger's Side Sliding Door Windows

T-Slider Bay Window Sets

CAT. NO.	SIZE (W X H)	STYLE	WALL	INSTALLS IN
VW21601L	43" x 20-3/4"	Angled 3° x 2°	1/8"	Driver's Side Forward
VW21611L	55" x 20-3/4"	Angled 2° x 11°	1/8"	Driver's Side Rear
VW21611R	55" x 21"	Angled 11° x 2°	1/8"	Passenger's Side Rear
VW21391L	40" x 25-3/4"	Rectangle 90° x 90°	1/8"	Driver's Side Forward
VW21421L	40-1/8" x 25-5/8"	Angled 90° x 17°	1/8"	Driver's Side Rear
VW21421R	40-1/8" x 25-5/8"	Angled 17° x 90°	1/8"	Passenger's Side Rear
VW21522L*	41-1/2" x 27"	Angled 3° x 3°	1/4"	Driver's Side Forward
VW21532L*	41-1/2" x 26-1/2"	Angled 3° x 3°	1/4"	Driver's Side Rear
VW21532R*	41-1/2" x 26-1/2"	Angled 3° x 3°	1/4"	Passenger's Side Rear
VW21381L*	40" x 25-3/4"	Rectangle 90° x 90°	1/8"	Driver's Side Forward
VW21431L*	40-1/8" x 25-5/8"	Angled 90° x 17°	1/8"	Driver's Side Rear
VW21431R*	40-1/8" x 25-5/8"	Angled 17° x 90°	1/8"	Passenger's Side Rear
VW21452L#	40-1/16" x 27-1/8"	Rectangle 90° x 90°	1/4"	Driver's Side Forward
VW21462L#	40-1/16" x 27-1/8"	Angled 90° x 17°	1/4"	Driver's Side Rear
VW21462R#	40-1/16" x 27-1/8"	Angled 17° x 90°	1/4"	Passenger's Side Rear

* Stainless Steel Accent in Black Frame. # Bronze Glass.

Fixed Glass Door Windows

CAT. NO.	SIZE (W X H)	STYLE	WALL	INSTALLS IN
VW40163	14" x 20-1/2"	Rectangle 90° x 90°	1/2"	40% Hinged Side Door
VW40143	18-13/16" x 20-1/2"	Angled 90° x 4°	1/2"	60% Hinged Side Door
VW40093R	40-3/8" x 20-1/2"	Angled 90° x 3°	1/2"	Sliding Side Door
VW40173	22-3/16" x 18-5/8"	Angled 6° x 90°	1/2"	LH Hinged Rear Door
VW40183	20-7/16" x 18-5/8"	Angled 90° x 6°	1/2"	RH Hinged Rear Door
VW40161	14" x 20-1/2"	Rectangle 90° x 90°	1/8"	40% Hinged Side Door
VW40141	18-13/16" x 20-1/2"	Angled 90° x 4°	1/8"	60% Hinged Side Door
VW40091R	40-3/8" x 20-1/2"	Angled 3° x 90°	1/8"	Sliding Side Door
VW40171	22-3/16" x 18-5/8"	Angled 6° x 90°	1/8"	LH Hinged Rear Door
VW40181	20-7/16" x 18-5/8"	Angled 90° x 6°	1/8"	RH Hinged Rear Door

T-Slider Bay Windows

BLACK FRAME



Rectangle



Angled

BLACK FRAME WITH STAINLESS ACCENT STRIP



Angled



Rectangle

Fixed Glass Door Windows

HINGED SIDE DOORS



40%



60%



LH



RH

SLIDING SIDE DOOR



Rectangle

NOTE: In vans with sliding side doors it is recommended to measure the height of the sliding door mechanism to make sure the sidewall will accept the window being ordered. Measure from 2" below the drip rail to approximately 2" above the sliding door track mechanism.

CRL Conventional Frame Van Windows Ford '75 - '91 Full Size Vans

- Dark Gray Tinted Glass
- Some Styles Available with Stainless Accent Strip
- Comes with 1/8", 1/4", 1" or 2-1/4" Wall Clamp Rings



Whether you are just adding windows to a cargo van for increased visibility or doing a complete van conversion, CRL has the windows to complete the job. Choose our Accent Frame Windows for that custom look, or our standard windows. Both will provide improved ventilation and visibility for passengers.

NOTE: Cut-out dimensions are provided. To determine which window to order for replacement purposes, deduct 1-1/4" from the overall outside frame dimensions of your existing window to determine the cut-out size as shown on this page. All dimensions are taken at the longest point side-to-side and top-to-bottom.

NOTE: Because of their custom fit design, specific model applications are not interchangeable between van manufacturers.

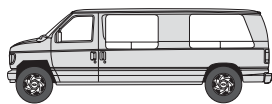

Driver's Side Forward and Rear Windows

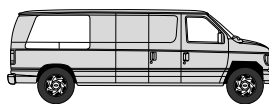

Passenger's Side Rear Window



Rear Door Windows

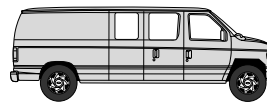

Passenger's Side Hinged Door Windows

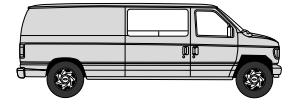

Passenger's Side Sliding Door Windows

T-Slider Bay Window Sets

CAT. NO.	SIZE (W X H)	STYLE	WALL	INSTALLS IN
VW21201L	29-3/16" x 28-1/4"	Rectangle 90° x 90°	1/8"	Driver's Side Forward
VW21481L	40" x 28-1/8"	Rectangle 90° x 90°	1/8"	Driver's Side Rear
VW21481R	40" x 28-1/8"	Rectangle 90° x 90°	1/8"	Passenger's Side Rear
VW21201L	29-3/16" x 28-1/4"	Rectangle 90° x 90°	1/8"	Driver's Side Forward
VW21491L	40-1/16" x 28-1/8"	Angled 90° x 17°	1/8"	Driver's Side Rear
VW21491R	40-1/16" x 28-1/8"	Angled 17° x 90°	1/8"	Passenger's Side Rear
VW21391L	40" x 25-3/4"	Rectangle 90° x 90°	1/8"	Driver's Side Forward
VW21562L	44" x 25-13/16"	Angled 90° x 15°	1/4"	Driver's Side Rear
VW21562R	44" x 25-13/16"	Angled 15° x 90°	1/4"	Passenger's Side Rear
VW21471L*	40" x 28-1/8"	Rectangle 90° x 90°	1/8"	Driver's Side Forward
VW21571L*	48-1/16" x 28-1/8"	Angled 90° x 17°	1/8"	Driver's Side Rear
VW21571R*	48-1/16" x 28-1/8"	Angled 17° x 90°	1/8"	Passenger's Side Rear
VW21191L*	29-3/16" x 28-7/16"	Rectangle 90° x 90°	1/8"	Driver's Side Forward
VW21501L*	40-1/16" x 28-1/8"	Angled 90° x 17°	1/8"	Driver's Side Rear
VW21501R*	40-1/16" x 28-1/8"	Angled 17° x 90°	1/8"	Passenger's Side Rear

* Stainless Steel Accent in Black Frame.

Fixed Glass Door Windows

CAT. NO.	SIZE (W X H)	STYLE	WALL	INSTALLS IN
VW40132	18-9/16" x 18-3/8"	Rectangle 90° x 90°	1/4"	Hinged Side Door
VW40135	18-9/16" x 18-3/8"	Rectangle 90° x 90°	1"	Hinged Side Door
VW40139	18-9/16" x 18-3/8"	Rectangle 90° x 90°	2-1/4"	Hinged Side Door
VW40152	20-13/16" x 18-7/16"	Rectangle 90° x 90°	1/4"	Hinged Rear Door
VW40155	20-13/16" x 18-7/16"	Rectangle 90° x 90°	1"	Hinged Rear Door
VW40159	20-13/16" x 18-7/16"	Rectangle 90° x 90°	2-1/4"	Hinged Rear Door
VW40082	43-11/16" x 18-3/8"	Rectangle 90° x 90°	1/4"	Sliding Side Door
VW40086	43-11/16" x 18-3/8"	Rectangle 90° x 90°	1-1/4"	Sliding Side Door

NOTE: In vans with sliding side doors it is recommended to measure the height of the sliding door mechanism to make sure the sidewall will accept the window being ordered. Measure from 2" below the drip rail to approximately 2" above the sliding door track mechanism.

T-Slider Bay Windows

BLACK FRAME



Rectangle



Angled

BLACK FRAME WITH STAINLESS ACCENT STRIP



Rectangle



Angled

Fixed Glass Door Windows

BOTH HINGED SIDE DOORS



BOTH HINGED REAR DOORS



SLIDING SIDE DOOR

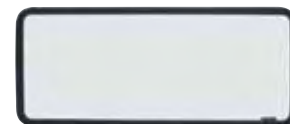

LOG ON TO crlaurence.com FOR BUSINESS-TO-BUSINESS SERVICES

A476 | PHONE (800) 421-6144 | FAX (800) 262-3299 TOLL FREE FROM ANYWHERE IN THE U.S.A. OR CANADA

CRL Conventional Frame Minivan Windows Ford Aerostar '90 - '96 Minivans

- Fixed, T-Slider and Half Slider Styles
- Dark Gray Tinted Glass
- Powder-Coated Frames



Windows for the Ford Aerostar are contoured to fit the van perfectly. Our windows increase driver visibility, and provide additional ventilation for passenger comfort. Windows are available in Fixed, T-Slider and Half Slider configurations.

NOTE: Cut-out dimensions are provided. To determine which window to order for replacement purposes, deduct 1-1/4" from the overall outside frame dimensions of your existing window to determine the cut-out size as shown on this page. All dimensions are taken at the longest point side-to-side and top-to-bottom.

NOTE: Because of their custom fit design, specific model applications are not interchangeable between van manufacturers.

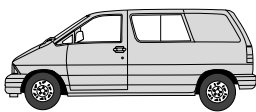

Driver's Side Forward Window

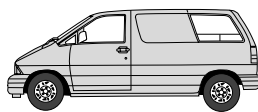

Driver's Side Rear Window



Rear Door Windows

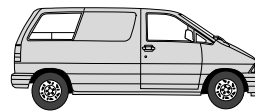

Passenger's Side Rear Window

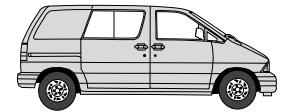

Passenger's Side Sliding Door Windows

Slider Bay Window Sets

CAT. NO.	TYPE	SIZE (W X H)	STYLE	WALL	INSTALLS IN
VW60249L	Half Slider	25-1/2" x 17"	Angled 3° x 17°	2-1/4"	Driver's Side Forward
VW60289L	Half Slider	28-1/2" x 16-3/8"	Angled 13° x 23°	2-1/4"	Driver's Side Rear
VW60289R	Half Slider	28-1/2" x 16-3/8"	Angled 23° x 13°	2-1/4"	Passenger's Side Rear
VW60299L	Half Slider	34-11/16" x 16-5/16"	Angled 13° x 13°	2-1/4"	Driver's Side Forward
VW60289L	Half Slider	28-1/2" x 16-3/8"	Angled 13° x 23°	2-1/4"	Driver's Side Rear
VW60289R	Half Slider	28-1/2" x 16-3/8"	Angled 23° x 13°	2-1/4"	Passenger's Side Rear
VW21291L	T-Slider	33-1/2" x 19"	Angled 15° x 15°	1/8"	Driver's Side Rear
VW21291R	T-Slider	33-1/2" x 19"	Angled 15° x 15°	1/8"	Passenger's Rear Side

Slider Bay Windows

BLACK FRAME



T-Slider



Half Slider

Fixed Glass Bay Window Sets

CAT. NO.	TYPE	SIZE (W X H)	STYLE	WALL	INSTALLS IN
VW40291L	Fixed	34-11/16" x 16-5/16"	Angled 13° x 13°	1/8"	Driver's Side Forward
VW11011L	Fixed	28" x 19"	Angled 15° x 23°	1/8"	Driver's Side Rear
VW11011R	Fixed	28" x 19"	Angled 23° x 15°	1/8"	Passenger's Side Rear
VW40299L	Fixed	34-11/16" x 16-5/16"	Angled 13° x 13°	2-1/4"	Driver's Side Forward
VW40289L	Fixed	28-1/2" x 16-3/8"	Angled 13° x 23°	2-1/4"	Driver's Side Rear
VW40289R	Fixed	28-1/2" x 16-3/8"	Angled 23° x 13°	2-1/4"	Passenger's Side Rear

Fixed Glass Bay Windows



Angled

Hinged Rear Door Windows

CAT. NO.	TYPE	SIZE (W X H)	STYLE	WALL	INSTALLS IN
VW40041L	Fixed	22-5/8" x 18-5/16"	Angled 12° x 90°	1/8"	LH Rear Door
VW40041R	Fixed	22-5/8" x 18-5/16"	Angled 90° x 12°	1/8"	RH Rear Door

Hinged Rear Door Windows



LH



RH

Angled

Sliding Side Door Windows

CAT. NO.	TYPE	SIZE (W X H)	STYLE	WALL	INSTALLS IN
VW40293R	Fixed	34-11/16" x 16-5/16"	Angled 13° x 13°	1/2"	Sliding Side Door
VW60293R	Half Slider	34-11/16" x 16-5/16"	Angled 13° x 13°	1/2"	Sliding Side Door

Sliding Side Door Windows

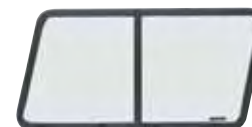

Half Slider



Angled

Fixed

CRL "All Glass Look" Van Windows Chevy/GMC '97+ Full Size Vans



- High Tech "Aero" Look
- Dark Solar Glass
- Silk Screen Frit Edge
- Contoured to Match Van Walls
- Comes with 1/8" Wall Clamp Ring

These windows combine the features, ventilation and installation ease of van conversion windows with the high-tech "aero" look of factory bonded glass. With pre-contoured dark solar glass, silk screen frit edge, sturdy powder-coated frames, and smooth reliable hardware, CRL's "All Glass Look" Van Windows are the "cutting edge" in beauty, quality and value! All come standard with 1/8" wall clamp rings.

NOTE: Cut-out dimensions are provided. To determine which window to order for replacement purposes, deduct 1-1/4" from the overall outside frame dimensions of your existing window to determine the cut-out size as shown on this page. All dimensions are taken at the longest point side-to-side and top-to-bottom.

NOTE: Because of their custom fit design, specific model applications are not interchangeable between van manufacturers.



Driver's Side Forward and Rear Windows



Passenger's Side Rear Window



Rear Door Windows



Passenger's Side Hinged Door Windows



Passenger's Side Sliding Door Windows

T-Vent Bay Window Sets

CAT. NO.	SIZE (W X H)	STYLE	INSTALLS IN
FW111L	41-1/2" x 27"	Rectangle 90° x 90°	Driver's Side Forward
FW121L	41-1/2" x 27"	Angled 90° x 6°	Driver's Side Rear
FW121R	41-1/2" x 27"	Angled 6° x 90°	Passenger's Side Rear
FW411L	42-5/8" x 27-3/8"	Rectangle 90° x 90°	Driver's Side Forward
FW421L	42-5/8" x 27-3/8"	Angled 90° x 7°	Driver's Side Rear
FW421R	42-5/8" x 27-3/8"	Angled 7° x 90°	Passenger's Side Rear

T-Vent Bay Windows



Rectangle



Angled

Fixed Glass Bay Window Sets

CAT. NO.	SIZE (W X H)	STYLE	INSTALLS IN
FW112L	41-1/2" x 27"	Rectangle 90° x 90°	Driver's Side Forward
FW122L	41-1/2" x 27"	Angled 90° x 6°	Driver's Side Rear
FW122R	41-1/2" x 27"	Angled 6° x 90°	Passenger's Side Rear
FW412L	42-5/8" x 27-3/8"	Rectangle 90° x 90°	Driver's Side Forward
FW422L	42-5/8" x 27-3/8"	Angled 90° x 7°	Driver's Side Rear
FW422R	42-5/8" x 27-3/8"	Angled 7° x 90°	Passenger's Side Rear

Fixed Glass Bay Windows



Rectangle



Angled

Fixed Glass Door Windows

CAT. NO.	SIZE (W X H)	STYLE	INSTALLS IN
FW131	16-7/16" x 20-7/8"	Rectangle 90° x 90°	40% Side of Hinged and Sliding Side Doors
FW141	21-1/4" x 21-1/8"	Rectangle 90° x 90°	60% Side of Hinged Side Door
FW151	22-3/8" x 19-5/16"	Angled 10° x 90°	LH Hinged Rear Door
FW161	22-3/8" x 19-5/16"	Angled 90° x 10°	RH Hinged Rear Door

NOTE: Because of structural concerns, CRL recommends two 40% Fixed Glass Windows, Cat. No. FW131, in the side sliding door location, one on each side of the vertical beam which should not be cut.

Fixed Glass Door Windows

HINGED SIDE DOORS



40%



60%



Angled

HINGED REAR DOORS

SLIDING SIDE DOOR



40%



40%



Angled



CRL Conventional Frame Van Windows Chevy/GMC '97+ Full Size Vans

- Popular Replacement Sizes Contoured to Match Side Walls and Doors
- T-Slider Bay Windows are Screened
- Dark Gray Tinted Glass
- Comes with 1/8" Wall Clamp Rings



CRL not only provides you with state-of-the-art design "All Glass Look" Van Windows, but continues to supply the industry with the conventional framed windows that have been the industry standard for years. CRL's Conventional Framed Van Windows not only offer the value prices you need to compete, but also offer a source for replacement windows for those thousands of vans with windows that fit within these dimensions. All come standard with 1/8" wall clamp rings.

NOTE: Cut-out dimensions are provided. To determine which window to order for replacement purposes, deduct 1-1/4" from the overall outside frame dimensions of your existing window to determine the cut-out size as shown on this page. All dimensions are taken at the longest point side-to-side and top-to-bottom.

NOTE: Because of their custom fit design, specific model applications are not interchangeable between van manufacturers.

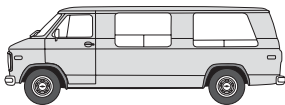

Driver's Side Forward and Rear Windows

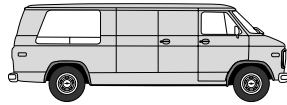

Passenger's Side Rear Window



Rear Door Windows

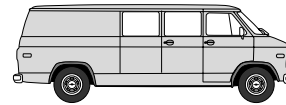

Passenger's Side Hinged Door Windows

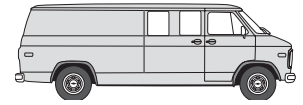

Passenger's Side Sliding Door Windows

T-Slider Bay Window Set

CAT. NO.	SIZE (W X H)	STYLE	INSTALLS IN
VW21391L	40" x 25-3/4"	Rectangle 90° x 90°	Driver's Side Forward
VW21421L	40-1/8" x 25-5/8"	Angled 90° x 17°	Driver's Side Rear
VW21421R	40-1/8" x 25-5/8"	Angled 17° x 90°	Passenger's Side Rear

T-Slider Bay Windows

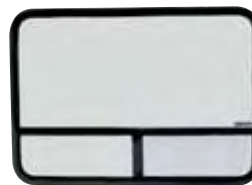

Rectangle



Angled

Fixed Glass Door Windows

CAT. NO.	SIZE (W X H)	STYLE	INSTALLS IN
VW40381	16-3/8" x 21-1/8"	Rectangle 90° x 90°	40% Side of Hinged and Sliding Side Doors
VW40371	21-1/4" x 21-1/8"	Rectangle 90° x 90°	60% Side of Hinged Side Door
VW40391L	22-3/8" x 19-5/16"	Angled 10° x 90°	LH Hinged Rear Door
VW40391R	22-3/8" x 19-5/16"	Angled 90° x 10°	RH Hinged Rear Door

NOTE: Because of structural concerns, CRL recommends two 40% Fixed Glass Windows, Cat. No. VW40381, in the side sliding door location, one on each side of the vertical beam, which should not be cut.

Fixed Glass Door Windows



40%

Rectangle

60%

40%

Rectangle

40%

HINGED REAR DOORS



LH

Angled

RH

CRL Conventional Frame Minivan Windows Chevy Astro and GMC Safari 1985+ Minivans

- Fixed, T-Slider and Half Slider Styles
- Dark Gray Tinted Glass
- Powder-Coated Frames



1985+ Chevy Astro or GMC Safari minivan windows are available in Fixed, T-Slider and Half Slider configurations. Some suggested styles are listed below. All windows have dark gray tinted glass. Some models can be chosen with either the standard black frame or with stainless steel accent strip.

NOTE: Cut-out dimensions are provided. To determine which window to order for replacement purposes, deduct 1-1/4" from the overall outside frame dimensions of your existing window to determine the cut-out size as shown on this page. All dimensions are taken at the longest point side-to-side and top-to-bottom.

NOTE: Because of their custom fit design, specific model applications are not interchangeable between van manufacturers.

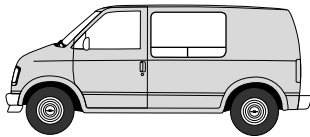

Driver's Side
Forward Window

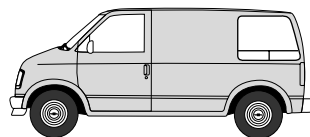

Driver's Side
Rear Window

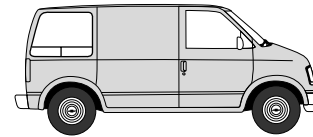

Passenger's Side
Rear Window

T-Slider Bay Window Sets

CAT. NO.	TYPE	SIZE (W X H)	STYLE	WALL	INSTALLS IN
VW21321L*	T-Slider	34" x 24"	Rectangle 90° x 90°	1/8"	Driver's Side Forward
VW21141L*	T-Slider	27" x 24"	Angled 90° x 10°	1/8"	Driver's Side Rear
VW21141R*	T-Slider	27" x 24"	Angled 10° x 90°	1/8"	Passenger's Side Rear
VW21321L*	T-Slider	34" x 24"	Rectangle 90° x 90°	1/8"	Driver's Side Forward
VW21161L*	T-Slider	29-3/8" x 24-1/16"	Angled 90° x 10°	1/8"	Driver's Side Rear
VW21161R*	T-Slider	29-3/8" x 24-1/16"	Angled 10° x 90°	1/8"	Passenger's Side Rear
VW21321L*	T-Slider	34" x 24"	Rectangle 90° x 90°	1/8"	Driver's Side Forward
VW21262L*	T-Slider	31-5/8" x 24"	Angled 90° x 10°	1/8"	Driver's Side Rear
VW21262R*	T-Slider	31-5/8" x 24"	Angled 10° x 90°	1/8"	Passenger's Side Rear
VW21321L*	T-Slider	34" x 24"	Rectangle 90° x 90°	1/8"	Driver's Side Forward
VW21321L*	T-Slider	34" x 24"	Rectangle 90° x 90°	1/8"	Driver's Side Rear
VW21321R*	T-Slider	34" x 24"	Rectangle 90° x 90°	1/8"	Passenger's Side Rear
VW21351L	T-Slider	38" x 21"	Rectangle 90° x 90°	1/8"	Driver's Side Forward
VW21131L	T-Slider	27" x 24"	Angled 90° x 10°	1/8"	Driver's Side Rear
VW21131R	T-Slider	27" x 24"	Angled 10° x 90°	1/8"	Passenger's Side Rear
VW21351L	T-Slider	38" x 21"	Rectangle 90° x 90°	1/8"	Driver's Side Forward
VW21151L	T-Slider	29" x 20-7/8"	Angled 90° x 12°	1/8"	Driver's Side Rear
VW21151R	T-Slider	29" x 20-7/8"	Angled 12° x 90°	1/8"	Passenger's Side Rear
VW21351L	T-Slider	38" x 21"	Rectangle 90° x 90°	1/8"	Driver's Side Forward
VW21301L	T-Slider	34" x 21"	Angled 90° x 12°	1/8"	Driver's Side Rear
VW21301R	T-Slider	34" x 21"	Angled 12° x 90°	1/8"	Passenger's Side Rear
VW50279L	T-Slider	37-3/4" x 19-1/2"	Angled 90° x 2°	2-1/4"	Driver's Side Forward
VW50269L	T-Slider	28-9/16" x 18-3/16"	Angled 2° x 10°	2-1/4"	Driver's Side Rear
VW50269R	T-Slider	28-9/16" x 18-3/16"	Angled 10° x 2°	2-1/4"	Passenger's Side Rear

* Stainless Steel Accent in Black Frame.

T-Slider Bay Windows

BLACK FRAME WITH STAINLESS ACCENT STRIP



Rectangle



Angled

BLACK FRAME



Rectangle



Angled



LOG ON TO crlaurence.com FOR BUSINESS-TO-BUSINESS SERVICES

A480 | PHONE (800) 421-6144 | FAX (800) 262-3299 TOLL FREE FROM ANYWHERE IN THE U.S.A. OR CANADA

CRL Conventional Frame Minivan Windows Chevy Astro and GMC Safari 1985+ Minivans

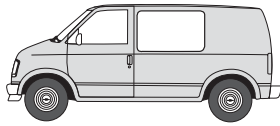

Driver's Side Forward Window

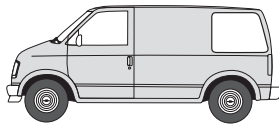

Driver's Side Rear Window

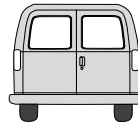

Rear Door Windows

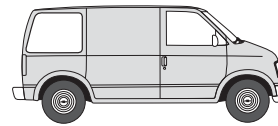

Passenger's Side Rear Window

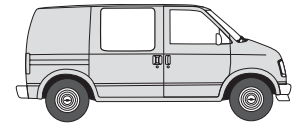

Passenger's Side Sliding Door Windows

Fixed Glass Bay Window Sets

CAT. NO.	TYPE	SIZE (W X H)	STYLE	WALL	INSTALLS IN
VW40271L	Fixed	37-3/4" x 19-1/2"	Angled 90° x 2°	1/8"	Driver's Side Forward
VW40261L	Fixed	28-9/16" x 18-3/16"	Angled 2° x 10°	1/8"	Driver's Side Rear
VW40261R	Fixed	28-9/16" x 18-3/16"	Angled 10° x 2°	1/8"	Passenger's Side Rear
VW40279L	Fixed	37-3/4" x 19-1/2"	Angled 90° x 2°	2-1/4"	Driver's Side Forward
VW40269L	Fixed	28-9/16" x 18-3/16"	Angled 2° x 10°	2-1/4"	Driver's Side Rear
VW40269R	Fixed	28-9/16" x 18-3/16"	Angled 10° x 2°	2-1/4"	Passenger's Side Rear

Fixed Glass Bay Windows

BLACK FRAME



Rectangle



Angled

Hinged Rear Door Windows

CAT. NO.	TYPE	SIZE (W X H)	STYLE	WALL	INSTALLS IN
VW40253L	Fixed	23-11/16" x 19-3/8"	Angled 10° x 90°	1/2"	LH Rear Door
VW40253R	Fixed	23-11/16" x 19-3/8"	Angled 90° x 10°	1/2"	RH Rear Door
VW50253L	T-Slider	23-11/16" x 19-3/8"	Angled 10° x 90°	1/2"	LH Rear Door
VW50253R	T-Slider	23-11/16" x 19-3/8"	Angled 90° x 10°	1/2"	RH Rear Door

Hinged Rear Door Windows



Angled Fixed



Angled T-Slider

Sliding Side Door Windows

CAT. NO.	TYPE	SIZE (W X H)	STYLE	WALL	INSTALLS IN
VW40271R	Fixed	37-3/4" x 19-1/2"	Angled 2° x 90°	1/8"	Sliding Side Door
VW40274R	Fixed	37-3/4" x 19-1/2"	Angled 2° x 90°	3/4"	Sliding Side Door
VW21351R	T-Slider	38" x 21"	Rectangle 90° x 90°	1/8"	Sliding Side Door
VW50274R	T-Slider	37-3/4" x 19-1/2"	Angled 2° x 90°	3/4"	Sliding Side Door
VW60274R	Half Slider	37-3/4" x 19-1/2"	Angled 2° x 90°	3/4"	Sliding Side Door

Sliding Side Door Windows



Fixed



T-Slider



Half Slider

CRL Conventional Frame Van Windows Chevy/GMC '71 – '96 Full Size Vans

- Some Styles Available with Stainless Steel Accent Strip
- Dark Gray Tinted Glass
- Comes with 1/8", 1/4" or 3/4" Wall Clamp Rings

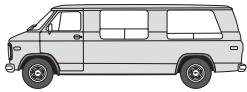

Driver's Side Forward and Rear Windows

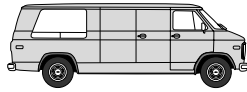

Passenger's Side Rear Window



Rear Door Windows



Passenger's Side Hinged Door Windows

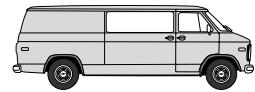

Passenger's Side Sliding Door Windows

T-Slider Bay Window Sets

CAT. NO.	TYPE	SIZE (W X H)	STYLE	WALL	INSTALLS IN
VW21481L	T-Slider	40" x 28-1/8"	Rectangle 90° x 90°	1/8"	Driver's Side Forward
VW21491L	T-Slider	40-1/16" x 28-1/8"	Angled 90° x 17°	1/8"	Driver's Side Rear
VW21491R	T-Slider	40-1/16" x 28-1/8"	Angled 17° x 90°	1/8"	Passenger's Side Rear
VW21471L*	T-Slider	40" x 28-1/8"	Rectangle 90° x 90°	1/8"	Driver's Side Forward
VW21501L*	T-Slider	40-1/16" x 28-1/8"	Angled 90° x 17°	1/8"	Driver's Side Rear
VW21501R*	T-Slider	40-1/16" x 28-1/8"	Angled 17° x 90°	1/8"	Passenger's Side Rear
VW21201L	T-Slider	29-3/16" x 28-1/4"	Rectangle 90° x 90°	1/8"	Driver's Side Forward
VW21581L	T-Slider	48-1/16" x 28-1/8"	Angled 90° x 17°	1/8"	Driver's Side Rear
VW21581R	T-Slider	48-1/16" x 28-1/8"	Angled 17° x 90°	1/8"	Passenger's Side Rear
VW21191L*	T-Slider	29-3/16" x 28-7/16"	Rectangle 90° x 90°	1/8"	Driver's Side Forward
VW21571L*	T-Slider	48-1/16" x 28-1/8"	Angled 90° x 17°	1/8"	Driver's Side Rear
VW21571R*	T-Slider	48-1/16" x 28-1/8"	Angled 17° x 90°	1/8"	Passenger's Side Rear
VW21391L	T-Slider	40" x 25-3/4"	Rectangle 90° x 90°	1/8"	Driver's Side Forward
VW21562L	T-Slider	44" x 25-13/16"	Angled 90° x 15°	1/4"	Driver's Side Rear
VW21562R	T-Slider	44" x 25-13/16"	Angled 15° x 90°	1/4"	Passenger's Side Rear

* Stainless Steel Accent in Black Frame.

T-Slider Bay Windows

BLACK FRAME



Rectangle



Angled

BLACK FRAME WITH STAINLESS ACCENT STRIP



Hinged Side Door Windows

CAT. NO.	TYPE	SIZE (W X H)	STYLE	WALL	INSTALLS IN
VW40204	Fixed	12-7/8" x 16-3/4"	Rectangle 90° x 90°	3/4"	40% Side Door
VW40194	Fixed	24-1/2" x 16-3/4"	Rectangle 90° x 90°	3/4"	60% Side Door

Hinged Door Windows



40% Side



60% Side



Rear

Hinged Rear Door Windows

CAT. NO.	TYPE	SIZE (W X H)	STYLE	WALL	INSTALLS IN
VW40121	Fixed	21-7/8" x 17-1/8"	Rectangle 90° x 90°	1/8"	Both Rear Doors
VW40124	Fixed	21-7/8" x 17-1/8"	Rectangle 90° x 90°	3/4"	Both Rear Doors

For the Hinged Rear Doors, choose two of either Cat. No. VW40121 or VW40124, depending on the wall thickness that you want to use.

Sliding Side Door Windows

CAT. NO.	TYPE	SIZE (W X H)	STYLE	WALL	INSTALLS IN
VW40071	Fixed	44-7/8" x 17-1/8"	Rectangle 90° x 90°	1/8"	Sliding Side Door
VW40074	Fixed	44-7/8" x 17-1/8"	Rectangle 90° x 90°	3/4"	Sliding Side Door
VW60071	Half Slider	44-7/8" x 17-1/8"	Rectangle 90° x 90°	1/8"	Sliding Side Door
VW60074	Half Slider	44-7/8" x 17-1/8"	Rectangle 90° x 90°	3/4"	Sliding Side Door
VW50074R	T-Slider	44-7/8" x 17-1/8"	Rectangle 90° x 90°	3/4"	Sliding Side Door

Sliding Side Door Windows



Half Slider



T-Slider

Rectangle



LOG ON TO crlaurence.com FOR BUSINESS-TO-BUSINESS SERVICES

A482 | PHONE (800) 421-6144 | FAX (800) 262-3299 TOLL FREE FROM ANYWHERE IN THE U.S.A. OR CANADA

CRL Universal Flat Surface Windows

- All Purpose Windows for Vans, Campers, RVs, Travel and Equipment Trailers, Livestock Trailers, Sleepover Cabs, or Just About Anywhere You Need a Quality Sliding Window
- Available in Stock Sizes or Custom Built to Order



Our Universal Flat Surface Windows are the 'all-purpose solution' to ventilate and increase visibility in just about any vehicle with flat walls. The frames are made of extruded aluminum with a black powder-coated finish, formed to surround dark gray tinted tempered safety glass. The sliding panel has a positive locking latch for security, and the ventilating panel is screened. Universal handing lets you use them on the right hand, left hand, or back side of the vehicle because built-in weep holes allow for proper drainage. Trim ring thickness options are 1-1/2" and 2-1/4". The 2-1/4" ring is reversible for 1/8" skin-mount applications.

We offer three stock sizes of Vertical Lift Sliders, and four stock sizes of Horizontal Half Sliders. You also have the option of ordering custom sizes. We can make Universal Flat Surface Windows to your custom specifications for size, format, glass color, and trim ring thickness. With this much versatility, it's easy to see why our Universal Flat Surface Windows are the 'all-purpose solution' to many of your window needs. We welcome the opportunity to quote your requirements. Please contact CRL Auto Technical Sales at (800) 421-6144, Ext. 7780, or by e-mail techsales@crlaurence.com.

CRL Horizontal Half Sliders



CAT. NO.	CUT-OUT		WALL
	W	H	
VW8209	20"	15-1/2"	*2-1/4"
VW8206	20"	15-1/2"	1-1/2"
VW8249	24"	15-1/2"	*2-1/4"
VW8246	24"	15-1/2"	1-1/2"
VW8369	36"	15-1/2"	*2-1/4"
VW8366	36"	15-1/2"	1-1/2"
VW8409	40"	15-1/2"	*2-1/4"
VW8406	40"	15-1/2"	1-1/2"

- Four Stock Sizes
- 31% Dark Gray Safety Glass
- Metal Locking Latch
- Choice of Trim Rings

*Reversible trim ring for 1/8" wall applications.

CRL Vertical Lift Sliders

- Three Stock Sizes
- 31% Dark Gray Safety Glass
- Metal Locking Latch
- Choice of Trim Rings



CAT. NO.	CUT-OUT		WALL
	W	H	
VW7189	18"	28"	*2-1/4"
VW7186	18"	28"	1-1/2"
VW7249	24"	28"	*2-1/4"
VW7246	24"	28"	1-1/2"
VW7289	28"	28"	*2-1/4"
VW7286	28"	28"	1-1/2"

*Reversible trim ring for 1/8" wall applications.

NOTE: Cut-out dimensions are provided. To determine which window to order for replacement purposes, deduct 1-1/4" from the overall outside frame dimension of your existing window to determine the cut-out size as shown on this page. All dimensions are taken at the longest point side-to-side and top-to-bottom. All CRL Automotive Windows can be combined for quantity pricing.

CRL Angled Fixed Van Bay Windows

- Model Specific Windows for Chevy/GMC, Ford, and Dodge Vans, Plus Universal Models
- Black Frame, 31% Dark Gray Tinted Glass
- Contoured to Fit Perfectly



The Bay Windows in this chart are sorted first by their Outside Frame Dimensions, which allows you to quickly locate the correct size window for your customer. Then, we provide Hole Cut-Out Sizes, Vertical Edge Angles, and Wall Thicknesses for new installations. Finally, we show Typical Location and Typical Use for these windows. **NOTE:** These Bay Windows can be used almost anywhere the dimensions show they will fit, as their contours work well on most vans.

ANGLED FIXED VAN BAY WINDOWS

CAT. NO.	OUTSIDE FRAME		CUT-OUT		ANGLES	WALL	TYPICAL LOCATION*	TYPICAL USE
	WIDTH	HEIGHT	WIDTH	HEIGHT				
VW11001R^	26-1/16"	18"	24-13/16"	16-3/4"	17°/2°	1/8"	PSR	CARAVAN
VW11001L^	26-1/16"	18"	24 13/16"	16-3/4"	2°/17°	1/8"	DSR	CARAVAN
VW11011R	29-1/4"	20-1/4"	28"	19"	23°/15°	1/8"	PSR	AEROSTAR
VW11011L	29-1/4"	20-1/4"	28"	19"	15°/23°	1/8"	DSR	AEROSTAR
VW40289R	29-1/4"	17-1/8"	28-1/2"	16-3/8"	23°/13°	2-1/4"	PSR	AEROSTAR
VW40289L	29-1/4"	17-1/8"	28-1/2"	16-3/8"	13°/23°	2-1/4"	DSR	AEROSTAR
VW40261R	29-5/16"	19-9/16"	28-9/16"	18-13/16"	2°/10°	1/8"	PSR	ASTRO/SAFARI
VW40261L	29-5/16"	19-9/16"	28-9/16"	18-13/16"	10°/2°	1/8"	DSR	ASTRO/SAFARI
VW40269R	29-5/16"	19-9/16"	28-9/16"	18-13/16"	2°/10°	2-1/4"	PSR	ASTRO/SAFARI
VW40269L	29-5/16"	19-9/16"	28-9/16"	18-13/16"	10°/2°	2-1/4"	DSR	ASTRO/SAFARI
VW40239L	33-15/16"	17-7/8"	33-3/16"	17-1/8"	90°/3°	2-1/4"	DSF	CARAVAN
VW40291L	35-7/16"	17-1/16"	34-11/16"	16-5/16"	13°/13°	1/8"	DSF	AEROSTAR
VW40299L	35-7/16"	17-1/16"	34-11/16"	16-5/16"	13°/13°	2-1/4"	DSF	AEROSTAR
VW40661L	36-1/8"	20-7/8"	35-3/8"	20-1/8"	90°/9°	1/8"	DSR	ASTRO/SAFARI
VW40661R	36-1/8"	20-7/8"	35-3/8"	20-1/8"	9°/90°	1/8"	PSR	ASTRO/SAFARI
VW40271L	38-1/2"	20-1/4"	37-3/4"	19-1/2"	90°/2°	1/8"	DSR	ASTRO/SAFARI
VW40271R	38-1/2"	20-1/4"	37-3/4"	19-1/2"	2°/90°	1/8"	PSR	ASTRO/SAFARI
VW40279L	38-1/2"	20-1/4"	37-3/4"	19-1/2"	90°/2°	2-1/4"	DSF	ASTRO/SAFARI
VW40274R	38-1/2"	20-1/4"	37-3/4"	19-1/2"	2°/90°	3/4"	PSR	ASTRO/SAFARI
VW40091L	41-1/8"	21-1/4"	40-3/8"	20-1/2"	3°/90°	1/8"	DSF	FORD 92+
VW40099L	41-1/8"	21-1/4"	40-3/8"	20-1/2"	3°/90°	2-1/4"	DSF	FORD 92+
VW40631R	57-1/8"	21-1/4"	56-3/8"	20-1/2"	11°/2°	1/8"	PSR	FORD 92+
VW40631L	57-1/8"	21-1/4"	56-3/8"	20-1/2"	2°/11°	1/8"	DSR	FORD 92+

All measurements are shown in inches. All automotive windows can be combined for quantity pricing.

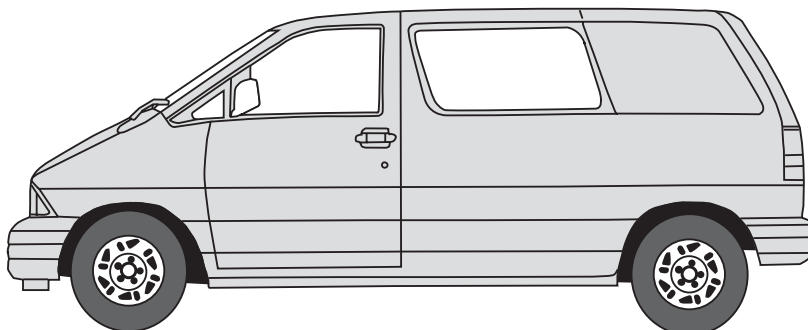

*TYPICAL LOCATION KEY

DSF = Driver's Side Forward

DSR = Driver's Side Rear

PSR = Passenger's Side Rear

^ = GL20 Glass



LOG ON TO crlaurence.com FOR BUSINESS-TO-BUSINESS SERVICES

A484 | PHONE (800) 421-6144 | FAX (800) 262-3299 TOLL FREE FROM ANYWHERE IN THE U.S.A. OR CANADA

CRL Half Slider Van Bay Windows

- Universal and Model Specific Van Windows Available
- Contoured to Fit Perfectly
- Dark Gray Tinted Glass Surrounded by Black Frames

The Bay Windows in these charts are sorted first by their Outside Frame Dimensions, which allows you to quickly locate the correct size window for your customer. Then, we provide Hole Cut-Out Sizes, Vertical Edge Angles, and Wall Thicknesses for new installations. Finally, we show Typical Location and Typical Use for these windows. **NOTE:** These Bay Windows can be used almost anywhere the dimensions show they will fit, as their contours work well on most vans.

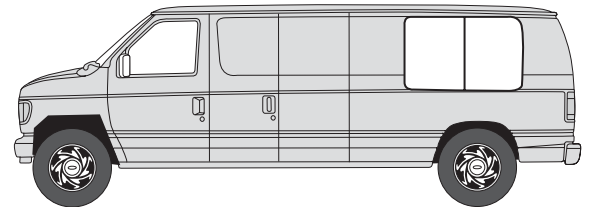

RECTANGULAR HALF SLIDER VAN BAY WINDOWS

CAT. NO.	OUTSIDE FRAME		CUT-OUT		WALL	TYPICAL LOCATION*	TYPICAL USE
	WIDTH	HEIGHT	WIDTH	HEIGHT			
VW60139	19-5/16"	19-1/8"	18-9/16"	18-3/8"	2-1/4"	DSF	FORD 75-91
VW60129	22-5/8"	17-7/8"	21-7/8"	17-1/8"	2-1/4"	DSF	CHEVY 71-96
VW60212	33-3/4"	15-1/2"	33"	14-3/4"	1/4"	UNIV	UNIVERSAL
VW60219	33-3/4"	15-1/2"	33"	14-3/4"	2-1/4"	UNIV	UNIVERSAL
VW60222	33-3/4"	17-15/16"	33"	17-3/16"	1/4"	UNIV	UNIVERSAL
VW60229	33-3/4"	17-15/16"	33"	17-3/16"	2-1/4"	UNIV	UNIVERSAL
VW60069	44-7/16"	18-3/8"	43-11/16"	17-5/8"	2-1/4"	DSF	DODGE 78+
VW60089	44-7/16"	19-1/8"	43-11/16"	18-3/8"	2-1/4"	DSF	FORD 75-91
VW60079	45-5/8"	17-7/8"	44-7/8"	17-1/8"	2-1/4"	DSF	CHEVY 71-96



*TYPICAL LOCATION KEY

DSF = Driver's Side Forward
UNIV = Universal

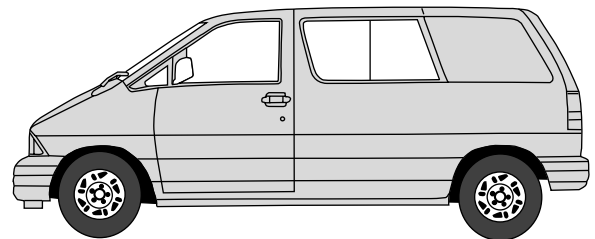

ANGLED HALF SLIDER VAN BAY WINDOWS

CAT. NO.	OUTSIDE FRAME		CUT-OUT		ANGLES	WALL	TYPICAL LOCATION*	TYPICAL USE
	WIDTH	HEIGHT	WIDTH	HEIGHT				
VW60249L	26-1/4"	17-3/4"	25-1/2"	17"	3°/17°	2-1/4"	DSR	CARAVAN/AEROSTAR
VW60249R	26-1/4"	17-3/4"	25-1/2"	17"	17°/3°	2-1/4"	PSR	CARAVAN/AEROSTAR
VW60289L	29-1/4"	17-1/8"	28-1/2"	16-3/8"	13°/23°	2-1/4"	DSR	AEROSTAR
VW60289R	29-1/4"	17-1/8"	28-1/2"	16-3/8"	23°/13°	2-1/4"	PSR	AEROSTAR
VW60239L	33-15/16"	17-7/8"	33-3/16"	17-1/8"	90°/3°	2-1/4"	DSF	CARAVAN
VW60299L	35-7/16"	17-1/16"	34-11/16"	16-5/16"	13°/13°	2-1/4"	DSF	AEROSTAR
VW60279L	38-1/2"	20-1/4"	37-3/4"	19-1/2"	90°/2°	2-1/4"	DSF	ASTRO/SAFARI
VW60091L	41-1/8"	21-1/4"	40-3/8"	20-1/2"	3°/90°	1/8"	DSF	FORD 92+
VW60099L	41-1/8"	21-1/4"	40-3/8"	20-1/2"	3°/90°	2-1/4"	DSF	FORD 92+

All measurements are shown in inches. All automotive windows can be combined for quantity pricing.

*TYPICAL LOCATION KEY

DSF = Driver's Side Forward
DSR = Driver's Side Rear
PSR = Passenger's Side Rear

CRL Rectangular Fixed Van Bay Windows

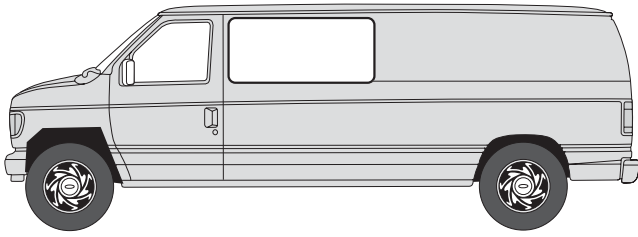

RECTANGULAR FIXED VAN BAY WINDOWS

CAT. NO.	OUTSIDE FRAME		CUT-OUT		WALL	TYPICAL LOCATION*	TYPICAL USE
	WIDTH	HEIGHT	WIDTH	HEIGHT			
VW40625	11-3/4"	16-3/4"	11"	16"	1"	UNIV	UNIVERSAL
VW40119	20-13/16"	18-3/8"	20-1/16"	17-5/8"	2-1/4"	DSF	DODGE 78+
VW40662	40-1/2"	21"	39-3/4"	20-1/4"	1/8"	DSF	ASTRO/SAFARI
VW40069	44-7/16"	18-3/8"	43-11/16"	17-5/8"	2-1/4"	DSF	DODGE 78+
VW40089	44-7/16"	19-1/8"	43-11/16"	18-3/8"	2-1/4"	DSF	FORD 75-91
VW40079	45-5/8"	17-7/8"	44-7/8"	17-1/8"	2-1/4"	DSF	CHEVY 71-96

CRL Vertical Lift Slider Van Bay Windows

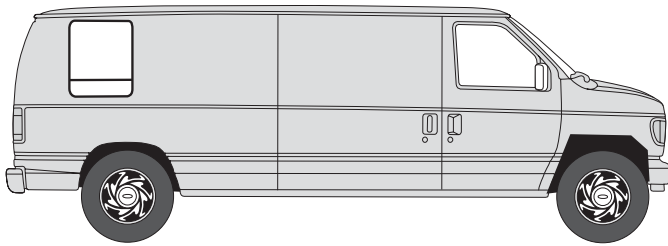

VERTICAL LIFT SLIDER VAN BAY WINDOWS

CAT. NO.	OUTSIDE FRAME		CUT-OUT		WALL	TYPICAL LOCATION*	TYPICAL USE
	WIDTH	HEIGHT	WIDTH	HEIGHT			
VW31031	17-15/16"	21-9/16"	16-11/16"	20-5/16"	1/8"	UNIV	UNIVERSAL
VW31041	17-15/16"	25-5/16"	16-11/16"	24-1/16"	1/8"	UNIV	UNIVERSAL
VW31051**	17-15/16"	25-5/16"	16-11/16"	24-1/16"	1/8"	UNIV	UNIVERSAL
VW31071	17-15/16"	29-5/16"	16-11/16"	28-1/16"	1/8"	UNIV	UNIVERSAL
VW31081**	17-15/16"	29-5/16"	16-11/16"	28-1/16"	1/8"	UNIV	UNIVERSAL
VW31091	17-15/16"	31-13/16"	16-11/16"	30-9/16"	1/8"	UNIV	UNIVERSAL
VW31101	19-3/16"	28-13/16"	17-15/16"	27-9/16"	1/8"	UNIV	UNIVERSAL
VW31111	21"	31-13/16"	19-3/4"	30-9/16"	1/8"	UNIV	UNIVERSAL
VW31121	25-1/4"	35-1/4"	24"	34"	1/8"	UNIV	UNIVERSAL
VW31231	29-3/4"	30"	28-1/2"	28-3/4"	1/8"	UNIV	UNIVERSAL
VW31171	30-7/16"	25-3/8"	29-3/16"	24-1/8"	1/8"	UNIV	UNIVERSAL
VW31191**	30-7/16"	29-11/16"	29-3/16"	28-7/16"	1/8"	UNIV	UNIVERSAL
VW31201	30-7/16"	29-5/16"	29-3/16"	28-1/16"	1/8"	UNIV	UNIVERSAL
VW31241	30-7/16"	31-13/16"	29-3/16"	30-9/16"	1/8"	UNIV	UNIVERSAL
VW31251**	30-7/16"	31-13/16"	29-3/16"	30-9/16"	1/8"	UNIV	UNIVERSAL

All measurements are shown in inches. All automotive windows can be combined for quantity pricing.

The Bay Windows in these charts are sorted first by their Outside Frame Dimensions, which allows you to quickly locate the correct size window for your customer. Then, we provide Hole Cut-Out Sizes, Vertical Edge Angles, and Wall Thickness dimensions for new installations. Finally, we show Typical Location and Typical Use for these windows. **NOTE:** These Bay Windows can be used virtually anywhere the dimensions show they will fit, as their contours work well on most vans.

***TYPICAL LOCATION KEY**
DSF = Driver's Side Forward
UNIV = Universal

** Stainless Steel Accent Frames



LOG ON TO crlaurence.com FOR BUSINESS-TO-BUSINESS SERVICES

A486 | PHONE (800) 421-6144 | FAX (800) 262-3299 TOLL FREE FROM ANYWHERE IN THE U.S.A. OR CANADA

CRL Rectangular T-Slider Van Bay Windows

The Bay Windows in this chart are sorted first by their Outside Frame Dimensions, which allows you to quickly locate the correct size window for your customer. Then, we provide Hole Cut-Out Sizes and Wall Thicknesses for new installations. Finally, we show the Typical Location and Typical Use for these windows. **NOTE:** These Bay Windows can be used virtually anywhere the dimensions show they will fit, as their contours work well on most vans.



RECTANGULAR T-SLIDER VAN BAY WINDOWS

CAT. NO.	OUTSIDE FRAME		CUT-OUT		WALL	TYPICAL LOCATION*	TYPICAL USE
	WIDTH	HEIGHT	WIDTH	HEIGHT			
VW21111L	21"	31-13/16"	19-3/4"	30-9/16"	1/8"	UNIV	UNIVERSAL
VW21111R	21"	31-13/16"	19-3/4"	30-9/16"	1/8"	UNIV	UNIVERSAL
VW50309L	24-3/4"	32-3/4"	24"	32"	2-1/4"	DSR	UNIVERSAL
VW50309R	24-3/4"	32-3/4"	24"	32"	2-1/4"	PSR	UNIVERSAL
VW21121L	25-1/4"	35-1/4"	24"	34"	1/8"	DSR	UNIVERSAL
VW21121R	25-1/4"	35-1/4"	24"	34"	1/8"	PSR	UNIVERSAL
VW50419L	28-3/4"	28-3/4"	28"	28"	2-1/4"	DSR	UNIVERSAL
VW50419R	28-3/4"	28-3/4"	28"	28"	2-1/4"	PSR	UNIVERSAL
VW21221L	30-1/4"	30-1/4"	29"	29"	1/8"	UNIV	UNIVERSAL
VW21221R	30-1/4"	30-1/4"	29"	29"	1/8"	UNIV	UNIVERSAL
VW21181L**	30-7/16"	25-3/8"	29-3/16"	24-1/8"	1/8"	UNIV	UNIVERSAL
VW21181R**	30-7/16"	25-3/8"	29-3/16"	24-1/8"	1/8"	UNIV	UNIVERSAL
VW21191L**	30-7/16"	29-11/16"	29-3/16"	28-7/16"	1/8"	UNIV	UNIVERSAL
VW21201L	30-7/16"	29-1/2"	29-3/16"	28-1/4"	1/8"	UNIV	UNIVERSAL
VW21201R	30-7/16"	29-1/2"	29-3/16"	28-1/4"	1/8"	UNIV	UNIVERSAL
VW21241L	30-7/16"	31-13/16"	29-3/16"	30-9/16"	1/8"	UNIV	UNIVERSAL
VW21241R	30-7/16"	31-13/16"	29-3/16"	30-9/16"	1/8"	UNIV	UNIVERSAL
VW21251L**	30-7/16"	31-13/16"	29-3/16"	30-9/16"	1/8"	UNIV	UNIVERSAL
VW21251R**	30-7/16"	31-13/16"	29-3/16"	30-9/16"	1/8"	UNIV	UNIVERSAL
VW21801L	32-11/16"	25-9/16"	31-7/16"	24-5/16"	1/8"	DSF	ASTRO/SAFARI
VW50319L	32-3/4"	24-3/4"	32"	24"	2-1/4"	DSR	UNIVERSAL
VW50319R	32-3/4"	24-3/4"	32"	24"	2-1/4"	PSR	UNIVERSAL
VW21791L^	33-3/16"	29-7/16"	31-15/16"	28-3/16"	1/8"	DSR	CARAVAN
VW21791R^	33-3/16"	29-7/16"	31-15/16"	28-3/16"	1/8"	PSR	CARAVAN
VW21271L	34-1/2"	18"	33-1/4"	16-3/4"	1/8"	DSR	UNIVERSAL
VW21271R	34-1/2"	18"	33-1/4"	16-3/4"	1/8"	PSR	UNIVERSAL
VW21311L	35-1/4"	25-1/4"	34"	24"	1/8"	DSR	UNIVERSAL
VW21311R	35-1/4"	25-1/4"	34"	24"	1/8"	PSR	UNIVERSAL
VW21321L**	35-1/4"	25-1/4"	34"	24"	1/8"	DSR	UNIVERSAL
VW21321R**	35-1/4"	25-1/4"	34"	24"	1/8"	PSR	UNIVERSAL
VW21351L	39-1/4"	22-1/4"	38"	21"	1/8"	DSR	ASTRO/SAFARI
VW21351R	39-1/4"	22-1/4"	38"	21"	1/8"	PSR	ASTRO/SAFARI
VW21361L**	39-1/4"	22-1/4"	38"	21"	1/8"	DSR	UNIVERSAL
VW21361R**	39-1/4"	22-1/4"	38"	21"	1/8"	PSR	UNIVERSAL
VW21381L**	41-1/4"	27"	40"	25-3/4"	1/8"	DSF	UNIVERSAL
VW21391L	41-1/4"	27"	40"	25-3/4"	1/8"	DSF	UNIVERSAL
VW21402L#	41-1/4"	27"	40"	25-3/4"	1/4"	DSF	FORD 92+
VW21471L**	41-1/4"	29-3/8"	40"	28-1/8"	1/8"	DSR	UNIVERSAL
VW21471R**	41-1/4"	29-3/8"	40"	28-1/8"	1/8"	PSR	UNIVERSAL
VW21481L	41-1/4"	29-3/8"	40"	28-1/8"	1/8"	DSR	UNIVERSAL
VW21481R	41-1/4"	29-3/8"	40"	28-1/8"	1/8"	PSR	UNIVERSAL
VW21452L#	41-5/16"	28-3/8"	40-1/16"	27-1/8"	1/4"	DSF	FORD 92+
VW21771L^	43-15/16"	28-11/16"	42-11/16"	27-7/16"	1/8"	DSF	MK III GM/FORD
VW50069L	44-7/16"	18-3/8"	43-11/16"	17-5/8"	2-1/4"	DSF	DODGE 78+
VW50089L	44-7/16"	19-1/8"	43-11/16"	18-3/8"	2-1/4"	DSF	FORD 75-91
VW50071L	45-5/8"	17-7/8"	44-7/8"	17-1/8"	1/8"	DSF	CHEVY 71-96
VW50079L	45-5/8"	17-7/8"	44-7/8"	17-1/8"	2-1/4"	DSF	CHEVY 71-96

All measurements are shown in inches. All automotive windows can be combined for quantity pricing.

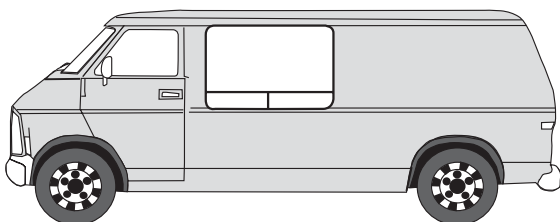

*TYPICAL LOCATION KEY

DSF = Driver's Side Forward
 DSR = Driver's Side Rear
 PSR = Passenger's Side Rear
 UNIV = Universal

** Stainless Steel Accent Frames

^ GL20 Glass

Bronze Glass

MK III Designates Conversion

Vans by Mark III Industries®

LOG ON TO crlaurence.com FOR BUSINESS-TO-BUSINESS SERVICES

PHONE (800) 421-6144 | FAX (800) 262-3299 TOLL FREE FROM ANYWHERE IN THE U.S.A. OR CANADA | A487



CRL Angled T-Slider Van Bay Windows

- Universal and Model Specific Van Windows Available
- Contoured to Fit Perfectly in Van Walls
- Dark Gray Tinted Glass Surrounded by Black Frames

The Bay Windows in this chart are sorted first by their Outside Frame Dimensions, which allows you to quickly locate the correct size window for your customer. Then, we provide Hole Cut-Out Sizes, Vertical Edge Angles, and Wall Thicknesses for new installations. Finally, we show the Typical Location and Typical Use for these windows. **NOTE:** These Bay Windows can be used virtually anywhere the dimensions show they will fit, as their contours work well on most vans.



ANGLED T-SLIDER VAN BAY WINDOWS

CAT. NO.	OUTSIDE FRAME		CUT-OUT		ANGLES	WALL	TYPICAL LOCATION*	TYPICAL USE
	WIDTH	HEIGHT	WIDTH	HEIGHT				
VW21131L	28-1/4"	25-1/4"	27"	24"	90°/10°	1/8"	DSR	ASTRO/SAFARI
VW21141L**	28-1/4"	25-1/4"	27"	24"	90°/10°	1/8"	DSR	ASTRO/SAFARI
VW21131R	28-1/4"	25-1/4"	27"	24"	10°/90°	1/8"	PSR	ASTRO/SAFARI
VW21141R**	28-1/4"	25-1/4"	27"	24"	10°/90°	1/8"	PSR	ASTRO/SAFARI
VW50269L	28-3/4"	19-9/16"	28"	18-13/16"	2°/10°	2-1/4"	DSR	ASTRO/SAFARI
VW50269R	28-3/4"	19-9/16"	28"	18-13/16"	10°/2°	2-1/4"	PSR	ASTRO/SAFARI
VW21151L	30-1/4"	22-1/8"	29"	20-7/8"	90°/12°	1/8"	DSR	ASTRO/SAFARI
VW21151R	30-1/4"	22-1/8"	29"	20-7/8"	12°/90°	1/8"	PSR	ASTRO/SAFARI
VW21161L**	30-5/8"	25-5/16"	29-3/8"	24-1/16"	90°/10°	1/8"	DSR	ASTRO/SAFARI
VW21161R**	30-5/8"	25-5/16"	29-3/8"	24-1/16"	10°/90°	1/8"	PSR	ASTRO/SAFARI
VW21811L	32-7/16"	25-9/16"	31-3/16"	24-5/16"	90°/10°	1/8"	DSR	ASTRO/SAFARI
VW21811R	32-7/16"	25-9/16"	31-3/16"	24-5/16"	10°/90°	1/8"	PSR	ASTRO/SAFARI
VW21262L**	32-7/8"	25-1/4"	31-5/8"	24"	90°/10°	1/4"	DSR	ASTRO/SAFARI
VW21262R**	32-7/8"	25-1/4"	31-5/8"	24"	10°/90°	1/4"	PSR	ASTRO/SAFARI
VW21281L	34-3/8"	18"	33-1/8"	16-3/4"	90°/17°	1/8"	DSR	CARAVAN
VW21281R	34-3/8"	18"	33-1/8"	16-3/4"	17°/90°	1/8"	PSR	CARAVAN
VW21291L	34-3/4"	20-1/4"	33-1/2"	19"	15°/15°	1/8"	DSR	AEROSTAR
VW21291R	34-3/4"	20-1/4"	33-1/2"	19"	15°/15°	1/8"	PSR	AEROSTAR
VW21301L	35-1/4"	22-1/4"	34"	21"	90°/12°	1/8"	DSR	ASTRO/SAFARI
VW21301R	35-1/4"	22-1/4"	34"	21"	12°/90°	1/8"	PSR	ASTRO/SAFARI
VW50279L	38-1/2"	20-1/4"	37-3/4"	19-1/2"	90°/2°	2-1/4"	DSF	ASTRO/SAFARI
VW21831L#	38-1/2"	27-5/8"	37-1/4"	26-3/8"	2°/4°	1/8"	DSR	MK III DODGE 78+
VW21831R#	38-1/2"	27-5/8"	37-1/4"	26-3/8"	4°/2°	1/8"	PSR	MK III DODGE 78+
VW50091L	41-1/8"	21-1/4"	40-3/8"	20-1/2"	3°/90°	1/8"	DSF	FORD 92+
VW50099L	41-1/8"	21-1/4"	40-3/8"	20-1/2"	3°/90°	2-1/4"	DSF	FORD 92+
VW21851L^	41-1/4"	26-11/16"	40"	25-7/16"	2°/4°	1/8"	DSR	MK III FORD
VW21851R^	41-1/4"	26-11/16"	40"	25-7/16"	4°/2°	1/8"	PSR	MK III FORD

All measurements are shown in inches. All automotive windows can be combined for quantity pricing.

*TYPICAL LOCATION KEY:

DSF = Driver's Side Forward
DSR = Driver's Side Rear
PSR = Passenger's Side Rear

** Stainless Steel Accent Frames
^ GL20 Glass
Bronze Glass
% Contempo Logo on Glass
MK III Designates Conversion
Vans by Mark III Industries®

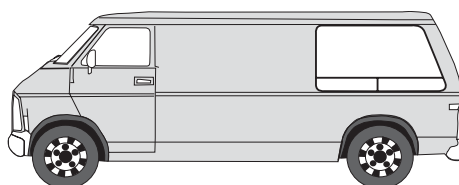
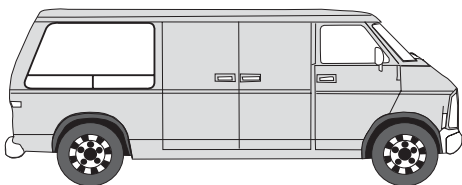

LOG ON TO crlaurence.com FOR BUSINESS-TO-BUSINESS SERVICES

A488 | PHONE (800) 421-6144 | FAX (800) 262-3299 TOLL FREE FROM ANYWHERE IN THE U.S.A. OR CANADA

CRL Angled T-Slider Van Bay Windows

• Models to Fit All Popular Full Size and Mini Vans

The Bay Windows in this chart are sorted first by their Outside Frame Dimensions, which allows you to quickly locate the correct size window for your customer. Then, we provide Hole Cut-Out Sizes, Vertical Edge Angles, and Wall Thicknesses for new installations. Finally, we show the Typical Location and Typical Use for these windows. **NOTE:** These Bay Windows can be used virtually anywhere the dimensions show they will fit, as their contours work well on most vans.



ANGLED T-SLIDER VAN BAY WINDOWS

CAT. NO.	OUTSIDE FRAME		CUT-OUT		ANGLES	WALL	TYPICAL LOCATION*	TYPICAL USE
	WIDTH	HEIGHT	WIDTH	HEIGHT				
VW21462L#	41-5/16"	28-3/8"	40-1/16"	27-1/8"	90°/17°	1/4"	DSR	FORD 92+
VW21491L	41-5/16"	29-3/8"	40-1/16"	28-1/8"	90°/17°	1/8"	DSR	UNIVERSAL
VW21501L**	41-5/16"	29-3/8"	40-1/16"	28-1/8"	90°/17°	1/8"	DSR	UNIVERSAL
VW21462R#	41-5/16"	28-3/8"	40-1/16"	27-1/8"	17°/90°	1/4"	PSR	FORD 92+
VW21491R	41-5/16"	29-3/8"	40-1/16"	28-1/8"	17°/90°	1/8"	PSR	UNIVERSAL
VW21501R**	41-5/16"	29-3/8"	40-1/16"	28-1/8"	17°/90°	1/8"	PSR	UNIVERSAL
VW21421L	41-3/8"	26-7/8"	40-1/8"	25-5/8"	90°/17°	1/8"	DSR	FORD 92+
VW21431L**	41-3/8"	26-7/8"	40-1/8"	25-5/8"	90°/17°	1/8"	DSR	FORD 92+
VW21441L**	41-3/8"	26-7/8"	40-1/8"	25-5/8"	90°/17°	1/8"	DSR	FORD 92+
VW21421R	41-3/8"	26-7/8"	40-1/8"	25-5/8"	17°/90°	1/8"	PSR	FORD 92+
VW21431R**	41-3/8"	26-7/8"	40-1/8"	25-5/8"	17°/90°	1/8"	PSR	FORD 92+
VW21441R**	41-3/8"	26-7/8"	40-1/8"	25-5/8"	17°/90°	1/8"	PSR	FORD 92+
VW21821L^	41-1/16"	28-1/8"	40-7/16"	26-7/8"	90°/2°	1/8"	DSF	MK III DODGE
VW21841L^	42-9/16"	27-3/16"	41-5/16"	25-15/16"	4°/2°	1/8"	DSF	MK III FORD
VW21522L**	42-3/4"	28-1/4"	41-1/2"	27"	3°/3°	1/4"	DSF	FORD 92+
VW21532L**	42-3/4"	27-3/4"	41-1/2"	26-1/2"	3°/3°	1/4"	DSR	FORD 92+
VW21542L	42-3/4"	27-3/4"	41-1/2"	26-1/2"	3°/3°	1/4"	DSR	FORD 92+
VW21552L	42-3/4"	28-1/4"	41-1/2"	27"	3°/3°	1/4"	DSR	FORD 92+
VW21532R**	42-3/4"	27-3/4"	41-1/2"	26-1/2"	3°/3°	1/4"	PSR	FORD 92+
VW21542R	42-3/4"	27-3/4"	41-1/2"	26-1/2"	3°/3°	1/4"	PSR	FORD 92+
VW21781L^	44"	28-11/16"	42-3/4"	27-7/16"	90°/17°	1/8"	DSR	MK III GM/FORD
VW21781R^	44"	28-11/16"	42-3/4"	27-7/16"	7°/90°	1/8"	PSR	MK III GM/FORD
VW21601L	44-1/4"	22"	43"	20-3/4"	3°/2°	1/8"	DSR	FORD 92+
VW21601R	44-1/4"	22"	43"	20-3/4"	2°/3°	1/8"	PSR	FORD 92+
VW21559L	44-3/4"	22-3/4"	43-1/2"	21-1/2"	3°/2°	2-1/4"	DSR	FORD 92+
VW21562L	45-1/4"	27-1/16"	44"	25-13/16"	90°/15°	1/4"	DSR	UNIVERSAL
VW21562R	45-1/4"	27-1/16"	44"	25-13/16"	15°/90°	1/4"	PSR	UNIVERSAL
VW21571L**	49-5/16"	29-3/8"	48-1/16"	28-1/8"	90°/17°	1/8"	DSR	UNIVERSAL
VW21581L	49-5/16"	29-3/8"	48-1/16"	28-1/8"	90°/17°	1/8"	DSR	UNIVERSAL
VW21571R**	49-5/16"	29-3/8"	48-1/16"	28-1/8"	17°/90°	1/8"	PSR	UNIVERSAL
VW21581R	49-5/16"	29-3/8"	48-1/16"	28-1/8"	17°/90°	1/8"	PSR	UNIVERSAL
VW21611R	56-1/4"	22-1/4"	55"	21"	11°/2°	1/8"	PSR	FORD 92+
VW21599L	56-3/4"	22-3/4"	55-1/2"	21-1/2"	2°/11°	2-1/4"	DSR	FORD 92+
VW21599R	56-3/4"	22-3/4"	55-1/2"	21-1/2"	11°/2°	2-1/4"	PSR	FORD 92+
VW21611L	57-5/8"	22"	56-3/8"	20-3/4"	2°/11°	1/8"	DSR	FORD 92+

All measurements are shown in inches. All automotive windows can be combined for quantity pricing.

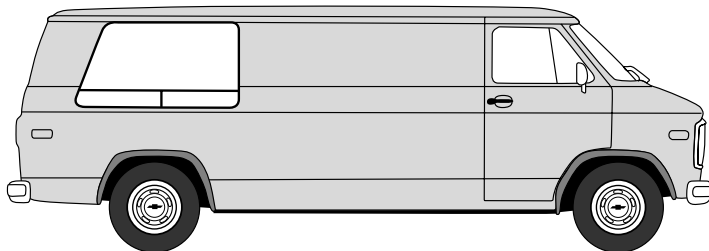

*TYPICAL LOCATION KEY

DSF = Driver's Side Forward
DSR = Driver's Side Rear
PSR = Passenger's Side Rear

** Stainless Steel Accent Frames

^ GL20 Glass

Bronze Glass

MK III Designates Conversion Vans by Mark III Industries®

CRL Fixed Van Door Windows

- Model Specific Windows for Chevy/GMC, Ford, and Dodge Vans
- Contoured Black Frames with 31% Dark Gray Tinted Glass



The Door Windows in these charts are sorted by their Outside Frame Dimensions, which allows you to quickly locate the correct size window for your customer. Then, we provide Hole Cut-Out Sizes, Vertical Edge Angles, and Wall Thickness Dimensions for new installations. Finally, we show the Typical Location and Intended Use for these windows. **NOTE:** Door Windows are typically suited only to the van makes shown in the charts.

***LOCATION KEY:**

SHDF = Side Hinged Door Forward

SHDR = Side Hinged Door Rear

HSD = Side Hinged Door Forward or Rear

SSD = Sliding Side Door

RD = Rear Door Driver or Passenger

SIDE SLIDING DOOR RECTANGULAR FIXED WINDOWS

CAT. NO.	OUTSIDE FRAME		CUT-OUT		WALL	TYPICAL LOCATION*	INTENDED USE
	WIDTH	HEIGHT	WIDTH	HEIGHT			
VW40062	44-7/16"	18-3/8"	43-11/16"	17-5/8"	1/4"	SSD	DODGE 78+
VW40065	44-7/16"	18-3/8"	43-11/16"	17-5/8"	1"	SSD	DODGE 78+
VW40082	44-7/16"	19-1/8"	43-11/16"	18-3/8"	1/4"	SSD	FORD 75-91
VW40086	44-7/16"	19-1/8"	43-11/16"	18-3/8"	1-1/4"	SSD	FORD 75-91
VW40071	45-5/8"	17-7/8"	44-7/8"	17-1/8"	1/8"	SSD	CHEVY 71-96
VW40074	45-5/8"	17-7/8"	44-7/8"	17-1/8"	3/4"	SSD	CHEVY 71-96

SIDE HINGED DOOR RECTANGULAR FIXED WINDOWS

CAT. NO.	OUTSIDE FRAME		CUT-OUT		WALL	TYPICAL LOCATION*	INTENDED USE
	WIDTH	HEIGHT	WIDTH	HEIGHT			
VW40204	13-5/8"	17-1/2"	12-7/8"	16-3/4"	3/4"	SHDR	CHEVY 71-96
VW40161	14-3/4"	21-1/4"	14"	20-1/2"	1/8"	SHDR	FORD 92+
VW40163	14-3/4"	21-1/4"	14"	20-1/2"	1/2"	SHDR	FORD 92+
VW40381	17-1/8"	21-7/8"	16-3/8"	21-1/8"	1/8"	SHDR	CHEVY 97+
VW40132	19-5/16"	19-1/8"	18-9/16"	18-3/8"	1/4"	HSD	FORD 75-91
VW40135	19-5/16"	19-1/8"	18-9/16"	18-3/8"	1"	HSD	FORD 75-91
VW40139	19-5/16"	19-1/8"	18-9/16"	18-3/8"	2-1/4"	HSD	FORD 75-91
VW40105	20-13/16"	16-3/8"	20-1/16"	15-5/8"	1"	HSD	DODGE 71-77
VW40112	20-13/16"	18-3/8"	20-1/16"	17-5/8"	1/4"	HSD	DODGE 78+
VW40115	20-13/16"	18-3/8"	20-1/16"	17-5/8"	1"	HSD	DODGE 78+
VW40371	22"	21-7/8"	21-1/4"	21-1/8"	1/8"	SHDF	CHEVY 97+
VW40121	22-5/8"	17-7/8"	21-7/8"	17-1/8"	1/8"	HSD	CHEVY 71-96
VW40124	22-5/8"	17-7/8"	21-7/8"	17-1/8"	3/4"	HSD	CHEVY 71-96
VW40194	25-1/4"	17-1/2"	24-1/2"	16-3/4"	3/4"	SHDF	CHEVY 71-96

REAR HINGED DOOR RECTANGULAR FIXED WINDOWS

CAT. NO.	OUTSIDE FRAME		CUT-OUT		WALL	TYPICAL LOCATION*	INTENDED USE
	WIDTH	HEIGHT	WIDTH	HEIGHT			
VW40152	21-9/16"	19-3/16"	20-13/16"	18-7/16"	1/4"	RD	FORD 75-91
VW40155	21-9/16"	19-3/16"	20-13/16"	18-7/16"	1"	RD	FORD 75-91
VW40159	21-9/16"	19-3/16"	20-13/16"	18-7/16"	2-1/4"	RD	FORD 75-91

All measurements are shown in inches. All automotive windows can be combined for quantity pricing.

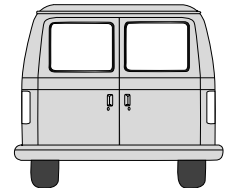
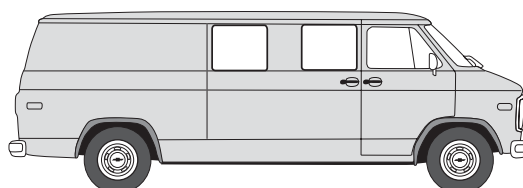
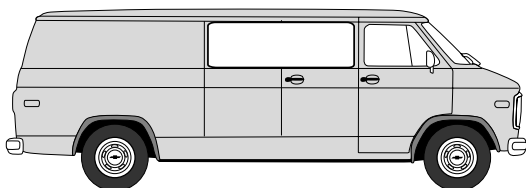

LOG ON TO crlaurence.com FOR BUSINESS-TO-BUSINESS SERVICES

A490 | PHONE (800) 421-6144 | FAX (800) 262-3299 TOLL FREE FROM ANYWHERE IN THE U.S.A. OR CANADA

CRL Fixed Van Door Windows

• Model Specific Sizes for Full Size and Mini Vans

The Door Windows in these charts are sorted by their Outside Frame Dimensions, which allows you to quickly locate the correct size window for your customer. Then, we provide Hole Cut-Out Sizes, Vertical Edge Angles, and Wall Thickness Dimensions for new installations. Finally, we show the Typical Location and Intended Use for these windows. **NOTE:** Door Windows are typically suited only to the van makes shown in the charts.



SIDE SLIDING DOOR ANGLED FIXED WINDOWS

CAT. NO.	OUTSIDE FRAME		CUT-OUT		ANGLES	WALL	TYPICAL LOCATION*	INTENDED USE
	WIDTH	HEIGHT	WIDTH	HEIGHT				
VW40235R	33-15/16"	17-7/8"	33-3/16"	17-1/8"	3°/90°	1"	SSD	CARAVAN
VW40293R	35-7/16"	17-1/16"	34-11/16"	16-5/16"	13°/13°	1/2"	SSD	AEROSTAR
VW40091R	41-1/8"	21-1/4"	40-3/8"	20-1/2"	90°/3°	1/8"	SSD	FORD 92+
VW40093R	41-1/8"	21-1/4"	40-3/8"	20-1/2"	90°/3°	1/2"	SSD	FORD 92+

SIDE HINGED DOOR ANGLED FIXED WINDOWS

CAT. NO.	OUTSIDE FRAME		CUT-OUT		ANGLES	WALL	TYPICAL LOCATION*	INTENDED USE
	WIDTH	HEIGHT	WIDTH	HEIGHT				
VW40141	19-9/16"	21-1/4"	18-13/16"	20-1/2"	90°/4°	1/8"	SHDF	FORD 92+
VW40143	19-9/16"	21-1/4"	18-13/16"	20-1/2"	90°/4°	1/2"	SHDF	FORD 92+



*LOCATION KEY:

SHDF = Side Hinged Door Forward
SHDR = Side Hinged Door Rear
SSD = Sliding Side Door
RDD = Rear Driver's Door
RPD = Rear Passenger's Door

REAR HINGED DOOR ANGLED FIXED WINDOWS

CAT. NO.	OUTSIDE FRAME		CUT-OUT		ANGLES	WALL	TYPICAL LOCATION*	INTENDED USE
	WIDTH	HEIGHT	WIDTH	HEIGHT				
VW40181	21-3/16"	19-3/8"	20-7/16"	18-5/8"	90°/6°	1/8"	RPD	FORD 92+
VW40183	21-3/16"	19-3/8"	20-7/16"	18-5/8"	90°/6°	1/2"	RPD	FORD 92+
VW40171	22-15/16"	19-3/8"	22-3/16"	18-5/8"	6°/90°	1/8"	RDD	FORD 92+
VW40173	22-15/16"	19-3/8"	22-3/16"	18-5/8"	6°/90°	1/2"	RDD	FORD 92+
VW40391R	23-1/8"	20-1/16"	22-3/8"	19-5/16"	90°/10°	1/8"	RPD	CHEVY 97+
VW40391L	23-1/8"	20-1/16"	22-3/8"	19-5/16"	10°/90°	1/8"	RDD	CHEVY 97+
VW40041R	23-3/8"	19-1/16"	22-5/8"	18-5/16"	90°/12°	1/8"	RPD	AEROSTAR
VW40041L	23-3/8"	19-1/16"	22-5/8"	18-5/16"	12°/90°	1/8"	RDD	AEROSTAR
VW40253R	24-7/16"	20-1/8"	23-11/16"	19-3/8"	90°/10°	1/2"	RPD	ASTRO
VW40253L	24-7/16"	20-1/8"	23-11/16"	19-3/8"	10°/90°	1/2"	RDD	ASTRO

All measurements are shown in inches. All automotive windows can be combined for quantity pricing.

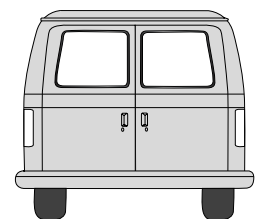
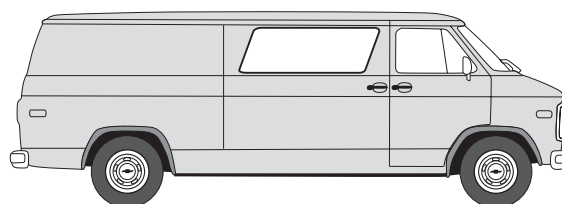
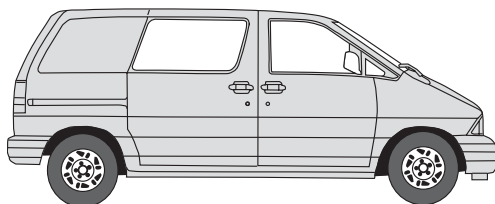

CRL T-Slider Van Door Windows

The Door Windows in these charts are sorted by their Outside Frame Dimensions, which allows you to quickly locate the correct size window for your customer. Then, we provide Hole Cut-Out Sizes, Vertical Edge Angles, and Wall Thickness Dimensions for new installations. Finally, we show the Typical Location and Intended Use for these windows.

NOTE: Door Windows are typically suited only to the van makes shown in the charts.



SIDE SLIDING DOOR RECTANGULAR T-SLIDER WINDOWS

CAT. NO.	OUTSIDE FRAME		CUT-OUT		ANGLES	WALL	TYPICAL LOCATION*	INTENDED USE
	WIDTH	HEIGHT	WIDTH	HEIGHT				
VW50065R	44-7/16"	18-3/8"	43-11/16"	17-5/8"	90°/90°	1"	SSD	DODGE 78+
VW50086R	44-7/16"	19-1/8"	43-11/16"	18-3/8"	90°/90°	1-1/4"	SSD	FORD 75-91
VW50074R	45-5/8"	17-7/8"	44-7/8"	17-1/8"	90°/90°	3/4"	SSD	CHEVY 71-96

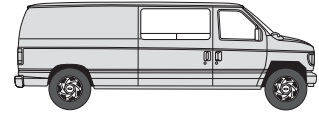

SIDE SLIDING DOOR ANGLED T-SLIDER WINDOWS

CAT. NO.	OUTSIDE FRAME		CUT-OUT		ANGLES	WALL	TYPICAL LOCATION*	INTENDED USE
	WIDTH	HEIGHT	WIDTH	HEIGHT				
VW50274R@	38-1/2"	20-1/4"	37-3/4"	19-1/2"	2°/90°	3/4"	SSD	ASTRO/SAFARI
VW50091R	41-1/8"	21-1/4"	40-3/8"	20-1/2"	90°/3°	1/8"	SSD	FORD 92+
VW50093R	41-1/8"	21-1/4"	40-3/8"	20-1/2"	90°/3°	1/2"	SSD	FORD 92+

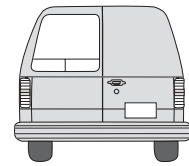

REAR HINGED DOOR ANGLED T-SLIDER WINDOWS

CAT. NO.	OUTSIDE FRAME		CUT-OUT		ANGLES	WALL	TYPICAL LOCATION*	INTENDED USE
	WIDTH	HEIGHT	WIDTH	HEIGHT				
VW50253L@	24-7/16"	20-1/8"	23-11/16"	19-3/8"	10°/90°	1/2"	RDD	ASTRO/SAFARI
VW50253R@	24-7/16"	20-1/8"	23-11/16"	19-3/8"	90°/10°	1/2"	RPD	ASTRO/SAFARI

*LOCATION KEY:

SHDF = Side Hinged Door Forward

SHDR = Side Hinged Door Rear

SSD = Sliding Side Door

RDD = Rear Driver's Door

RPD = Rear Passenger's Door

@ = For Installation in Blank Steel Doors Only

CRL Half Slider Van Door Windows



SIDE SLIDING DOOR ANGLED HALF SLIDER WINDOWS

CAT. NO.	OUTSIDE FRAME		CUT-OUT		ANGLES	WALL	TYPICAL LOCATION*	INTENDED USE
	WIDTH	HEIGHT	WIDTH	HEIGHT				
VW60235R	33-15/16"	17-7/8"	33-3/16"	17-1/8"	3°/90°	1"	SSD	CARAVAN
VW60293R	35-7/16"	17-1/16"	34-11/16"	16-5/16"	13°/13°	1/2"	SSD	AEROSTAR
VW60274R@	38-1/2"	20-1/4"	37-3/4"	19-1/2"	2°/90°	3/4"	SSD	ASTRO/SAFARI
VW60091R	41-1/8"	21-1/4"	40-3/8"	20-1/2"	90°/3°	1/8"	SSD	FORD 92+
VW60093R	41-1/8"	21-1/4"	40-3/8"	20-1/2"	90°/3°	1/2"	SSD	FORD 92+

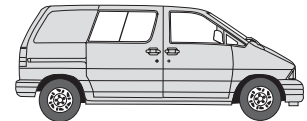

SIDE HINGED DOOR ANGLED HALF SLIDER WINDOWS

CAT. NO.	OUTSIDE FRAME		CUT-OUT		ANGLES	WALL	TYPICAL LOCATION*	INTENDED USE
	WIDTH	HEIGHT	WIDTH	HEIGHT				
VW60141	19-9/16"	21-1/4"	18-13/16"	20-1/2"	90°/4°	1/8"	SHDF	FORD 92+
VW60143	19-9/16"	21-1/4"	18-13/16"	20-1/2"	90°/4°	1/2"	SHDF	FORD 92+

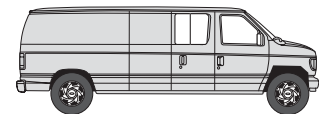

REAR HINGED DOOR ANGLED HALF SLIDER WINDOWS

CAT. NO.	OUTSIDE FRAME		CUT-OUT		ANGLES	WALL	TYPICAL LOCATION*	INTENDED USE
	WIDTH	HEIGHT	WIDTH	HEIGHT				
VW60181	21-3/16"	19-3/8"	20-7/16"	18-5/8"	90°/6°	1/8"	RPD	FORD 92+
VW60183	21-3/16"	19-3/8"	20-7/16"	18-5/8"	90°/6°	1/2"	RPD	FORD 92+
VW60171	22-15/16"	19-3/8"	22-3/16"	18-5/8"	6°/90°	1/8"	RDD	FORD 92+
VW60173	22-15/16"	19-3/8"	22-3/16"	18-5/8"	6°/90°	1/2"	RDD	FORD 92+

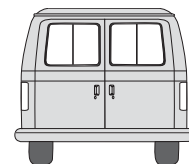

All measurements are shown in inches. All automotive windows can be combined for quantity pricing.



LOG ON TO crlaurence.com FOR BUSINESS-TO-BUSINESS SERVICES

A492 | PHONE (800) 421-6144 | FAX (800) 262-3299 TOLL FREE FROM ANYWHERE IN THE U.S.A. OR CANADA

CRL Half Slider Van Door Windows

- Model Specific Windows Contoured to Fit Chevy/GMC, Ford, and Dodge Vans
- 31% Dark Gray Tinted Glass Surrounded by Black Frames



The Door Windows in these charts are sorted by their Outside Frame Dimensions, which allows you to quickly locate the correct size window for your customer. Then, we provide Hole Cut-Out Sizes, Vertical Edge Angles, and Wall Thickness Dimensions for new installations. Finally, we show the Typical Location and Intended Use for these windows. **NOTE:** Door Windows are typically suited only to the van makes shown in the charts.

***LOCATION KEY:**

- SHDF = Side Hinged Door Forward
- SHDR = Side Hinged Door Rear
- SSD = Sliding Side Door
- HSD = Hinged Side Door
- RD = Rear Door Driver or Passenger

SIDE SLIDING DOOR RECTANGULAR HALF SLIDER WINDOWS

CAT. NO.	OUTSIDE FRAME		CUT-OUT		WALL	TYPICAL LOCATION*	INTENDED USE
	WIDTH	HEIGHT	WIDTH	HEIGHT			
VW60062	44-7/16"	18-3/8"	43-11/16"	17-5/8"	1/4"	SSD	DODGE 78+
VW60065	44-7/16"	18-3/8"	43-11/16"	17-5/8"	1"	SSD	DODGE 78+
VW60082	44-7/16"	19-1/8"	43-11/16"	18-3/8"	1/4"	SSD	FORD 75-91
VW60086	44-7/16"	19-1/8"	43-11/16"	18-3/8"	1-1/4"	SSD	FORD 75-91
VW60052	44-1/2"	16-1/16"	43-3/4"	15-5/16"	1/4"	SSD	DODGE 71-77
VW60055	44-1/2"	16-1/16"	43-3/4"	15-5/16"	1"	SSD	DODGE 71-77
VW60071	45-5/8"	17-7/8"	44-7/8"	17-1/8"	1/8"	SSD	CHEVY 71-96
VW60074	45-5/8"	17-7/8"	44-7/8"	17-1/8"	3/4"	SSD	CHEVY 71-96

SIDE HINGED DOOR RECTANGULAR HALF SLIDER WINDOWS

CAT. NO.	OUTSIDE FRAME		CUT-OUT		WALL	TYPICAL LOCATION*	INTENDED USE
	WIDTH	HEIGHT	WIDTH	HEIGHT			
VW60204	13-5/8"	17-1/2"	12-7/8"	16-3/4"	3/4"	SHDR	CHEVY 71-96
VW60161	14-3/4"	21-1/4"	14"	20-1/2"	1/8"	SHDR	FORD 92+
VW60163	14-3/4"	21-1/4"	14"	20-1/2"	1/2"	SHDR	FORD 92+
VW60132	19-5/16"	19-1/8"	18-9/16"	18-3/8"	1/4"	HSD	FORD 75-91
VW60135	19-5/16"	19-1/8"	18-9/16"	18-3/8"	1"	HSD	FORD 75-91
VW60102	20-7/8"	16-3/8"	20-1/8"	15-5/8"	1/4"	HSD	DODGE 71-77
VW60112	20-7/8"	18-3/8"	20-1/8"	17-5/8"	1/4"	HSD	DODGE 78+
VW60115	20-7/8"	18-3/8"	20-1/8"	17-5/8"	1"	HSD	DODGE 78+
VW60119	20-7/8"	18-3/8"	20-1/8"	17-5/8"	2-1/4"	HSD	DODGE 78+
VW60194	25-1/4"	17-1/2"	24-1/2"	16-3/4"	3/4"	SHDF	CHEVY 71-96

REAR HINGED DOOR RECTANGULAR HALF SLIDER WINDOWS

CAT. NO.	OUTSIDE FRAME		CUT-OUT		WALL	TYPICAL LOCATION*	INTENDED USE
	WIDTH	HEIGHT	WIDTH	HEIGHT			
VW60121	22-5/8"	17-7/8"	21-7/8"	17-1/8"	1/8"	RD	CHEVY 71-96
VW60124	22-5/8"	17-7/8"	21-7/8"	17-1/8"	3/4"	RD	CHEVY 71-96
VW60152	21-9/16"	19-3/16"	20-3/16"	18-7/16"	1/4"	RD	FORD 75-91
VW60155	21-9/16"	19-3/16"	20-13/16"	18-7/16"	1"	RD	FORD 75-91
VW60159	21-9/16"	19-3/16"	20-13/16"	18-7/16"	2-1/4"	RD	FORD 75-91

All measurements are shown in inches. All automotive windows can be combined for quantity pricing.

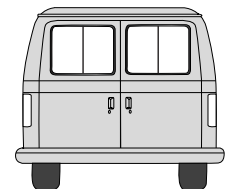
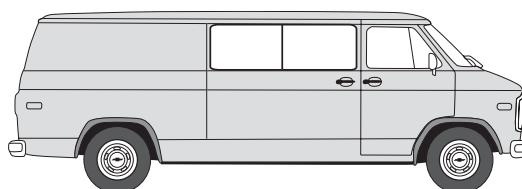
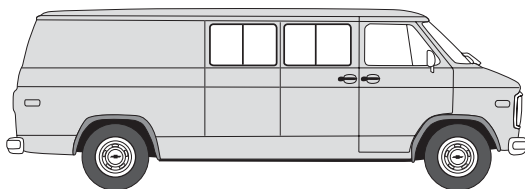

CRL Classic Van Porthole

- The Classic Van Accessory
- Glazed with Tinted Tempered Glass

CRL Classic Van Portholes install with a 1/8" or 1-1/2" reversible clamp ring. Their black powder-coated aluminum frames yield a professionally installed look. This traditional porthole design has 31% dark tinted tempered flat glass.

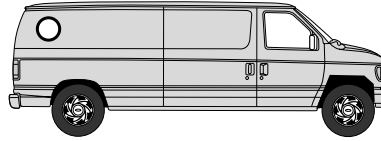

CAT. NO.	SIZE	CLAMP RING	GLASS COLOR
11035S	12" Circle	1/8" or 1-1/2"	Dark Tint

CRL His N' Hers Sunroofs

- Perfect for Vans
- Independently Adjustable

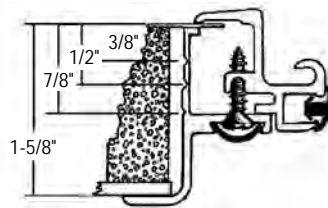

Van Trim Ring

New "modified" Van Trim Ring for deep headliner or panel. Features metal-to-metal contact, eliminating the need for blocking.



FRAME SIZE
17-5/8" x 17-5/8" O.D.

FRAME
Extruded Aluminum,
Black Powder-Coat Finish

CUT-OUT SIZE
16-5/8" x 16-5/8"

HANDLE
Three Position;
3-1/4" Maximum Opening

GLASS SIZE
15-1/8" x 15-1/8"

SEAL
Extruded Silicone Sponge

There is a word for the His N' Hers Sunroof - versatile. The compact 17" x 17" size makes this window the perfect choice for use as either a single or double unit. Placed side by side, they offer installation flexibility, as well as separate control of ventilation for individual comfort. The Solar Hi-Performance Glass can be removed easily for the exhilaration of "open-top" driving. The factory styling of this window is popular with van enthusiasts because single units can be installed over the back portion of the vehicle to illuminate and ventilate the rear.

CAT. NO.	GLASS TYPE	TRIM RING*
VT1717B4H	Solar Hi-Performance	Van
VT1717B5H	Solar Hi-Performance	Universal
VT1717B6H	Solar Hi-Performance	Molded

*For the correct trim ring application, contact your trim specialist, or the SFC/CRL Auto Tech Center. Can be combined with all CRL Automotive Windows for quantity pricing.

CRL Plexi-Dome Roof Vent

- Excellent for RV's, Campers and Vans
- Transparent, Smoke Colored Dome

The CRL Plexi-Dome Roof Vent has a sturdy, low profile Plexiglas dome that is a transparent smoke color. The dome is hinged at the front, and there is a built-in insect screen. It's easily installed in a 14" by 14" (355 mm by 355 mm) hole in the vehicle's roof.

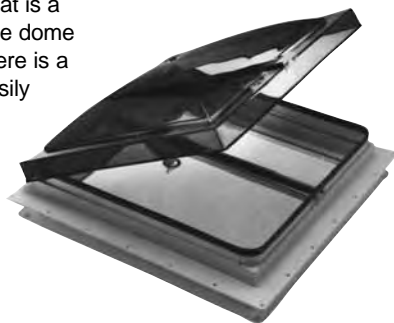

CAT. NO.	DESCRIPTION
257010S	Smoke Dome Vent

CRL Van Vents

- Fit Almost Any Van, Camper or RV
- Available with Built-In Fan

These CRL Van Vents fit in a 14" by 14" (355 mm by 355 mm) hole, and are hinged on the leading edge to allow air circulation. Crank-type operator lifts white plastic lid from closed to a 45° position. Built-in screening keeps insects out. Interior and exterior trim rings are a cream color that can be painted to match the vehicle.



CAT. NO.	DESCRIPTION
VV252	Van Vent
VV242	Van Vent with Built-in 12 Volt Fan



CRL Seat Belts

- Meet All Federal Motor Vehicle Specifications
- OEM Quality
- Available in Three Lengths

Our Seat Belts are extra long to accommodate custom van seats. They come in three lengths, and have retention clips to take up excess slack. CRL Seat Belts have pushbutton mechanisms for quick fastening and easy release. Best of all, they conform to SAE-J-4C and all Federal Motor Vehicle Safety Standards, so you can install them with confidence.



CAT. NO.	COLOR	LENGTH
FK65060BL	Black	60" (152.4 cm)
FK65074BL	Black	74" (188 cm)
FK650110BL	Black	110" (279.4 cm)

Sizes can be combined for quantity pricing.

CRL Door Pulls

- Available in Four Colors
- Steel Inner Core
- Snap-on Screw Covers

CRL Door Pulls have a steel inner core for strength, and a vinyl outer cover for durability. Woodgrain vinyl trim strip and snap-on screw covers accent this attractive accessory. Two per package.



CAT. NO.	COLOR	LENGTH
DP11BLU	Blue	12-1/4" (311 mm)
DP11BL	Black	12-1/4" (311 mm)
DP11S	Silver	12-1/4" (311 mm)
DP11T	Tan	12-1/4" (311 mm)

Colors can be combined for quantity pricing.

CRL Radius Window Foam Seal Tape

- Closed Cell
- Silicone Base
- Keeps Drafts and Water Out



The closed cell structure and silicone base makes our Radius Window Foam Seal Tape an excellent automotive grade weatherseal material. It has excellent "memory", and will keep drafts and water out of the van's interior when used to install our van windows.

CAT. NO.	WIDTH	THICKNESS	LENGTH
60701	1/2" (12.7 mm)	1/4" (6.3 mm)	50 Ft (15.2 m)

CRL Cup Holders

- Fold Away to Less Than 1" Thick

CRL Folding Cup and Can Holders secure drinks while the vehicle is moving. Cup and Can Holders open easily with one hand and fold away to less than 1" thick. Mount them to door or dash panels. Package comes with foam tape squares and screws. Overall size is 3-3/4" (95 mm) wide by 4" (102 mm) high.



CAT. NO.	COLOR
CUP1	Black
CUP3	Blue

Colors can be combined for quantity pricing.

CRL Screw Pack for Van Window Installation

- Color Matched to CRL Van Windows
- Waxed for Easier Starting



Our Screw Pack for Installation of CRL Van Windows contains 25 waxed black screws that will install the largest window CRL makes. The wax provides easy thread cutting ability, and helps to prevent the head of the screw from spinning off. The black color is the perfect match to CRL's state-of-the-art powder-coated van window frames.

CAT. NO.	SIZE	QTY/PACK
VW8X34S	No. 8 x 3/4" (19 mm)	25

At C.R. Laurence, We Do It Right!

When it comes to recreational vehicles and trailers, CRL is your source for the best in fully-framed, non-contoured windows. We make Side-Sliders, T-Sliders, Vertical Sliders, and Fixed Windows in dozens of shapes and sizes to meet the needs of manufacturers nationwide, and we can make just the right windows for you. Custom sizes and shapes are our specialty, and we would like to bid on the windows you need. You'll find that CRL can be very competitive in price and delivery schedules. Contact the CRL Auto Technical Center at (800) 421-6144, Ext. 7780 for details and our easy to complete Window Quote Request Form.

Campers



All CRL Automotive Windows are manufactured in our 270,000 square foot manufacturing facility in Vernon, California, just five minutes from CRL Corporate Headquarters and ten minutes from downtown Los Angeles. We use only the latest technology to produce the highest quality windows under strict QS9000 Certified Manufacturing Standards.

Trailers



With our continued commitment to supply all of your automotive window needs, C.R. Laurence offers an extensive range of RV and Trailer Windows. From fixed windows for camper doors, through sliding RV and Motor Home Windows, to Horse Trailer Feed Doors, C.R. Laurence has them all. Windows are available with sloped sills, sliding screens, various glass types and colors, and many different styles. Please allow us to quote your requirements.

Motor Homes



Horse Trailers



LOG ON TO crlaurence.com FOR BUSINESS-TO-BUSINESS SERVICES

A496 | PHONE (800) 421-6144 | FAX (800) 262-3299 TOLL FREE FROM ANYWHERE IN THE U.S.A. OR CANADA

CRL Raised Roof Windows

- Powder-Coated Frames
- 31% Dark Gray Tinted Tempered Glass

Fixed and Sliding Windows are available for installation into the sides of raised roofs. The most popular sizes are listed here. Custom sizes will be quoted on request. Models shown here have 15° angled sides.

CAT. NO.	HANDING	CUT-OUT		
		W	H	WALL
VW60011L	Driver	49"	10-5/8"	1/8"
VW60011R	Passenger	49"	10-5/8"	1/8"
VW60012L	Driver	49"	10-5/8"	1/4"
VW60012R	Passenger	49"	10-5/8"	1/4"
VW60021L	Driver	64-3/4"	10-5/8"	1/8"
VW60021R	Passenger	64-3/4"	10-5/8"	1/8"
VW60022L	Driver	64-3/4"	10-5/8"	1/4"
VW60022R	Passenger	64-3/4"	10-5/8"	1/4"
RV2713L	Driver	58-3/4"	10-9/16"	1/4"
RV2713R	Passenger	58-3/4"	10-9/16"	1/4"

All CRL Automotive Windows can be combined for quantity pricing.

NOTE: Cut-out dimensions are provided. To determine which window to order for replacement purposes, deduct 1-1/4" from the overall outside frame dimensions of your existing window to determine the cut-out size as shown on this page. All dimensions are taken at the longest point side-to-side and top-to-bottom.



CRL Fixed Door Windows

- Available Stock Sizes or Custom Made to Your Specifications

These Fixed Door Windows are made for doors in campers and RV's. With their small 1-3/4" corner radius and variety of glass colors, they are your best choice for door windows. Standard features include 1-3/8" clamp rings and black powder-coated frames. Custom sizes will be quoted on request.

CAT. NO.	HANDING	CUT-OUT		WALL	GLASS COLOR
		W	H		
RV26741	Universal	12"	25"	1-3/8"	55% Light Gray
RV2675	Universal	12"	12"	1-3/8"	Clear
RV26751	Universal	12"	12"	1-3/8"	31% Dark Gray

All CRL Automotive Windows can be combined for quantity pricing.



CRL Horse Trailer Windows

Horse Trailer Windows have black frames, dark gray tinted glass, and fixed fiberglass screens. All Horse Trailer Windows are universal (left hand or right hand) with 1-1/2" wall thickness, and are fitted with conventional outside pull handles. The Interior Trim Ring is also reversible for 1/8" skin-mount applications.

Horse Guards are internal clamp rings fitted with 1/2" diameter tubing, and are designed to fit our Horse Trailer Side Sliders. Inside security latch provided for optional use. Custom sizes will be quoted on request.

HORSE TRAILER SIDE SLIDERS

CAT. NO.	HANDING	CUT-OUT		
		W	H	WALL
HTW20013	Universal	20"	14"	1-1/2"
HTW20023	Universal	24"	14"	1-1/2"
HTW20033	Universal	30"	14"	1-1/2"
HTW20043	Universal	36"	14"	1-1/2"
HTW20053	Universal	48"	14"	1-1/2"

All CRL Automotive Windows can be combined for quantity pricing.



Horse Trailer Side Slider

- Available in Stock or Custom Sizes
- 31% Dark Gray Tinted Tempered Glass



Horse Guard

HORSE GUARDS

CAT. NO.	FITS WINDOW NO.
HTG0011	HTW20013
HTG0021	HTW20023
HTG0031	HTW20033
HTG0041	HTW20043
HTG0051	HTW20053

NOTE: CRL RV Windows are packaged without screws or mounting tape. To order these items, see page A495 for Cat. No. VW8X34S Screw Package, and Cat. No. 60701 Foam Mounting Tape.

CRL CUSTOM WINDOWS

For Pricing on CRL Products, Call Toll Free
(800) 421-6144, or Visit crlaurence.com

C.R. Laurence is a major manufacturer of Custom Windows for the automotive, mass transit, and marine industries. We make windows for Motor Homes, Fifth Wheel Trailers, Campers, and Pickup Shells. We supply Custom Windows to the makers of Big Rig Trucks, Transit Buses and Trams, Commuter Vans, Horse Trailers, Power Yachts, and Sailboats.

Fixed and sliding Custom Windows can be made to your specifications for shape, size, glass color, and body wall thickness. We welcome the opportunity to quote your Custom Window needs, and invite you to contact our Auto Technical Sales Center by e-mail at techsales@crlaurence.com.



**Whatever Your Window
Requirements, We Can
Make the Very Best for You**



LOG ON TO crlaurence.com FOR BUSINESS-TO-BUSINESS SERVICES

A498 | PHONE (800) 421-6144 | FAX (800) 262-3299 TOLL FREE FROM ANYWHERE IN THE U.S.A. OR CANADA



Mass Transit and Airport Buses*

Windows custom made in the U.S.A. to your exact requirements using our strict manufacturing standards. Let our engineers work with you to provide the right window for every application.

* Custom Manufactured Windows Depicted



Hotel Shuttle Buses and Vans*

Fixed or sliding window designs in a choice of glass colors.

Extended Vans for Corporate Pools or Airport Shuttles

Multi-Window applications which are interchangeable with prime installations.



C.R. Laurence, The Solution to All Your Vehicle Window Procurement Problems



LOG ON TO crlaurence.com FOR BUSINESS-TO-BUSINESS SERVICES

A500 | PHONE (800) 421-6144 | FAX (800) 262-3299 TOLL FREE FROM ANYWHERE IN THE U.S.A. OR CANADA

Finding What You Want is Quick and Easy When You Use Our A to Z Product Index at crlaurence.com

First log on to crlaurence.com and Click on **A to Z Product Index**.



Click on the first letter of the product you are looking for.

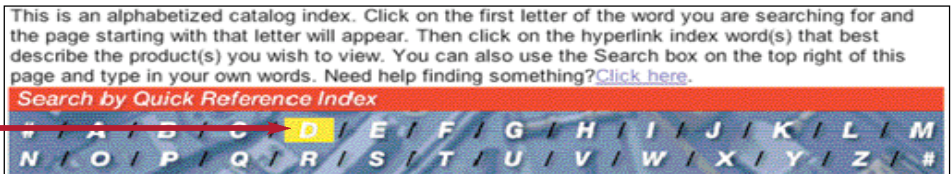

Click on the name of the product you are looking for. You'll get a list of colors, sizes or types of the product.



Click on the one you want. The product's Offer Page will appear with full information and prices for the product.



Short Cut:
Enter the Product's Catalog Number in the Product Search Here Box and Click Go. You'll go directly to the product's Offer Page!

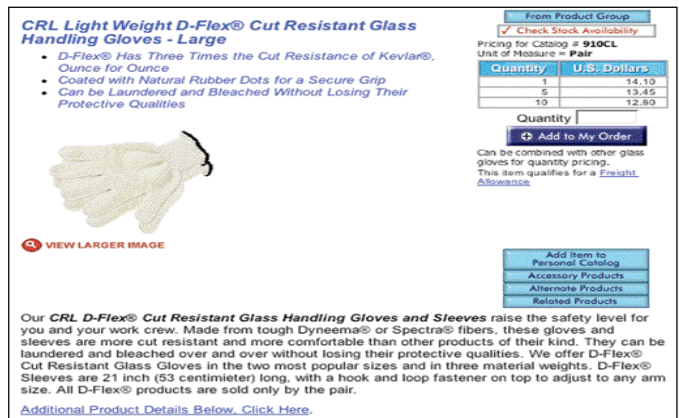

We Give You a Number of Ways to Find What You Want at crlaurence.com

The CRL Web Site is your source for many thousands of items, and we've devised a number of ways for you to quickly and easily find exactly what you want when you log on to crlaurence.com.

C.R. LAURENCE COMPANY INC.
AN ISO 9000 COMPANY
Supplying the World with Glazing, Industrial, Construction, Architectural and Automotive Supplies

Product Search Here

Log In Home Contact Us Bulletin Board Documents Product of the Month View Cart and Checkout

Auto Glass and Accessories Glass Hardware and Accessories Sealants, Tools and Accessories New Product Section

Non-Customer Menu
• New Account Request

Searching on CRL
• A to Z Product Index
• New Product Area
• Popular Product Lines

PRODUCT OF THE MONTH
SAVE 10% OR MORE ON OUR BEST-SELLING SILICONES AND BACKER ROD

INTERNET BONUS OFFERS
CLICK HERE to view what you can get this month

Special Limited Time Savings
OVER 1/2 OFF
ON CRL'S GLASS OPTIMIZING FASTCUT SOFTWARE

CRL CATALOG LIBRARY
GlassWedge Systems
BULLETIN BOARD

Numeric Index

Products can be located even if you know only part of the Catalog Number. Enter the first two or three characters into the Product Search Here Box then [Click Go](#).

You searched for "y6" Products 1-10 of 11 found

	Y61472 CRL Beaded Rigid Upper Division Bar for GM 1953-1963 - 72" Length • Stainless Steel Bead
	Y61496 CRL Beaded Rigid Upper Division Bar for GM 1953-1963 - 96" Length • Stainless Steel Bead
	Y619P96 CRL Beaded Rigid Division Bar for 1957-1967 Ford - 96" Length • Stainless Steel Bead

New Product Area

Here we preview for you our newest products and catalogs. Just click on any image and you'll be linked to that product's Offer Page for complete details, including pricing and availability.

Popular Product Lines

Some of our most popular product lines include hundreds of items. Here they are grouped so you can easily navigate through crlaurence.com to find exactly what you need. Think of it as a starting point for when you want to browse through all of the products in a related area.

CONSTRUCTION SEALANTS, TOOLS, AND ACCESSORIES



FINDING PRODUCTS AT crlaurence.com

Products By Industry

When you make this selection you will be guided to the product lines of the basic industry groups served by CRL.

AUTOMOTIVE WINDOWS, TOOLS, AND SUPPLIES



[Truck Sliding Windows](#)



[SFC/CRL Sunroofs and Replacement Parts](#)



[Van Windows](#)



[Automotive Adhesives and Sealants](#)

Products By Catalog

Products will be listed as they appear in each of our six new Master Catalogs as they are published. This will be starting point so you can browse through each of these catalogs independently when you visit crlaurence.com.

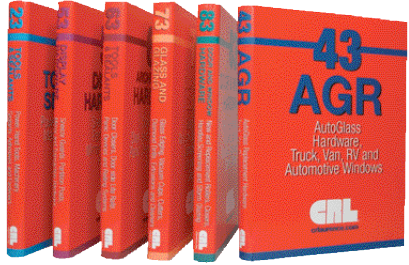

TO BEGIN YOUR SEARCH, PLEASE SELECT A CATALOG

Product Document Search

By entering the CRL Catalog Number and pressing Search, the results will display a list of all documents and drawings available for that product.

Product Document Search

By entering the CRL Catalog Number and pressing Search, the results will display a list of all documents and drawings available for that product. Under the title of each document type will be a hyper link that you can click on to start the process of viewing that information.

Search for Documents by Catalog Number:

Truck Slider Search

We make it easy for you to select the right CRL Slider for any pickup. All you need to know are three basic facts: Year, Make, and Model. Make your selection from the three 'drop-down' menus and you'll be presented with a selection of all CRL Sliders available to fit that truck.

Truck Slider Search

Ever Improving Quality and Features Make C.R. Laurence Today's Choice for High Quality Automotive Windows

CRL offers Sliders for almost any truck, some going back to 1948. You can quickly find the right Truck Slider by either entering your vehicle year, then make and model by moving your mouse (pointer) over each drop down menu and clicking, or by entering the NAGS Number.

When the results are displayed, read the description of the Slider you wish to view and click on the link. You will then go to a page where you can read about the Slider and make your purchase. (Businesses Only)

Search By Year, Make, and Model

LOG ON TO crlaurence.com FOR BUSINESS-TO-BUSINESS SERVICES

PHONE (800) 421-6144 | FAX (800) 262-3299 TOLL FREE FROM ANYWHERE IN THE U.S.A. OR CANADA | A503



43AGR CATALOG A TO Z PRODUCT INDEX

A

Abrasive		Filter Regulator Lubricator	A195	Tapes	A124-A126, A343-A346
Bands	A364	Hoses	A194	Trim Fasteners	A268-A272
Belt Lubricant	A163, A360	Nibbler	A382, A459	Upholstery Tools	A273-A276, A293
Belt Sanders	A358-A359, A362	Pressure Regulator and Gauge	A194	Vacuum Cups	A204-A206
Belts	A360-A361	Tool Accessories	A194-A195	Washers and Nuts	A298
Discs	A363	Air Bag Reference Guide	A167	Weatherstrip	A302-A309, A313-A315, A318-A321, A334-A336
Stick Tools	A365	Air-Flow Retention Tape	A342	Weatherstrip Clips	A336-A337
Acrylic Adhesive Tape	A348	All Glass Look Sliders	A401, A405	Window Guides	A280-A281
Acura Cowl Fasteners	A266	All Glass Look Van Windows	A466, A470-A471, A474, A478	Wire	A300
Acura Windshield Molding Clips	A253-A258	All Purpose Glass Cleaner	A148	AutoPort	
Adapters		All Purpose Screwdriver Set	A377	Sunroof Accessories	A458
Drill	A231	Alumin-Nu Metal Cleaner	A154	Sunroof Replacement Parts	A461
Felt Wheel	A229	Aluminum		Sunroofs	A452
Oscillating Power Tool	A191	Brackets, Door Glass	A277	Auto-Taps, ScotchLok	A300
UV Lamp	A221	Cleaner	A154	Auveco Screws	A294-A298
Adhesive		Files	A383	Auveco Weatherstrip Rubber	A319-A321
Applicator Guns	A146	Long Knives	A175	Awl, Scratch	A375
Cleaners and Removers	A152, A155	Saw Blade	A382		
Contact	A125	Angle Drill, Cordless	A369		
Gun Tips	A147	Angle Swivel	A195		
Guns and Pumps	A146-A147	Antenna Connector Repair Kit	A243	B	
Nozzles	A144-A145	Apex Bits	A374	Back Belt Suspenders	A392
Remover Pen	A153	Application Chart, Truck Sliders	A434-A441	Backglass Molding Clips	A246-A260
Removers	A152, A156	Applicator Gun	A146	Backglass Removal Blades	A445
Sprays	A139	Aprons	A394	Back Slider	
Tapes	A344, A347-A348	Arm Protectors	A389, A393	Gaskets	A442
Adhesives		Armor-All	A154	Installation Tools	A446
Aerosol	A139	Astro Van Windows	A480-A481	Latches	A443
Auto Polyurethane Sealant	A132	Atlas Fit Gloves	A389	Back Sliders	
Auto-Mix System	A135	A-Tork Maxi Wipes	A159	Duo-Vent	A406-A410, A414-A417, A422-A424, A427, A429, A431, A433-A434, A436-A441
Automotive Weatherstrip	A133, A229, A319	Auto AC Power Sources	A299	Oldies	A427
Channel Bonding	A135	Autoglass		POWR-Slider	A405-A408, A410, A413-A415, A417, A421-A424, A429-A432, A435-A440
Cleaners and Removers	A152-A153, A155-A156	Adhesive Comparison Chart	A106-A108	Tri-Vent	A405-A408, A410, A413-A415, A417, A421-A424, A429-A432, A435-A441
Duramix Urethane	A134	Adhesives and Sealants	A110-A124	Back Up Pads	A363
Epoxies	A135-A136, A138	Butyl Sealer	A125	Bags, Sunroof Glass	A457
Essex	A120-A121	Butyl Tape	A124-A125	Bags, Tool	A351-A352
Fast Tack	A133	Channels	A322-A331	Ball Stud	A449
Minute Bond	A137, A236	Cut-Out Knives	A168-A175, A184-A193, A196-A201	Banana Knives	A175
Molding	A339	Duramix Urethanes	A134	Bands, Sanding	A364
Plastic	A133	Locking Strip Tools	A310-A312	Bar, Scrape and Pry	A177, A353
Polyurethane	A132	Primer Daubers	A114	Basket, Tool	A352
Rear View Mirror	A236	Primers	A111, A113, A117-A118, A121, A123	Battery	
Sika	A116-A117	Racks	A208-A211	Cartridges and Chargers	A142-A143
Spray	A139	Setting Channels	A332-A333	Notching Saw	A357
Structural	A135	Setting Stick	A206	Operated Curing Lamp	A221
Super Bonder	A137, A236	Silicones	A129	Powered Caulking Guns	A142-A143
Super Weatherstrip	A133, A229, A319	Tape Kits	A124-A125	Bay Windows for Vans	A470-A482, A484-A489
3M	A122-A123	Technician's Starter Kit	A167	Beaded Glass Run Channel	A325-A327
Titan	A118-A119	Urethanes	A110-A123	Belt Polishing Grease	A163
Urethane Auto Glass	A110-A123	Vacuum Cups	A204-A206	Belt Polishing Oil	A161, A360
Weatherstrip	A133, A229, A319	Weatherstrip Tools	A306, A310-A312	Belt Sanders	
Windshield	A110-A124	Automotive		Bench Model	A359
Adjustable Wrenches	A378	Adhesives	A101-A125	Portable	A358-A359
Aegis		Bedding Compound	A125, A128	Upright	A362
Bull's Eye Maker Kit	A220	Channel Specimen Chain	A323	Belts	
Fixture Chamber	A220	Custom Windows	A498-A500	Abrasive	A360-A361
Injector Syringes	A219	Door and Window Tools	A273-A279	Polishing	A364
Inspection Cup with Mirror	A220	Door Pulls	A495	Portable Sander	A360, A364
Long Crack Repair Tape	A219	Edge Trim	A316-A317	Sanding	A360-A361
Mylar Squares	A220	Electrical Supplies	A300-A301	Seat	A495
Pit Fill Kit	A218	Lubricants	A160	Upright Sander	A361, A364
Quad Rings	A220	Masking Tape	A342-A344	Weight	A392
Repair Resins	A220	Molding Specimen Chain	A339	Wet Abrasive	A361
Windshield Repair Kits	A218-A219	Plastic Rivets	A245, A290		
Air		Rivet Tools	A278, A292		
Caulking Guns	A141	Rivets	A245, A288-A290		
Compressors	A194	RTV Silicones	A129		
Cut-Out Knives	A184-A185, A188, A190-A192	Screws	A294-A298		
		Sealants	A127-A132		



LOG ON TO crlaurence.com FOR BUSINESS-TO-BUSINESS SERVICES

A504 | PHONE (800) 421-6144 | FAX (800) 262-3299 TOLL FREE FROM ANYWHERE IN THE U.S.A. OR CANADA

43AGR CATALOG A TO Z PRODUCT INDEX

Bench		Boxes, Tool	A349-A350	Nozzle Cutter	A144
Grinder	A382	Brackets		Opener	A144
Sanders	A359	Door Glass	A277	Carts, Windshield	A211
Vises	A381	Rain and Light Sensor	A240	Caulk Tips, Reusable	A144
Bio-Clean Stain Remover	A150, A226	Rear View Mirror	A234-A235	Caulking Accessories	A144-A145
Big Daddy Riveter	A292	Wipes Dispenser	A159	Caulking Guns	
Big Rig Sliders	A427	Braided Windshield Wire	A182	Air Powered	A141
Bit Caddy	A375	Breaking Pliers, Glass	A356	Battery Powered	A142-A143
Bit Holders	A374	Bricks, Rubbing	A365	Bulk Loading	A140
Bits		Brushes		Cleaner	A153
Ball Burr	A225	Disposable	A114, A181	Cordless	A142-A143
Drill	A370	Dusting	A181	High Ratio	A140
Grinding	A364	Grime	A157	Manual	A140
Hex Insert	A374	BTB Cut-Out Tool Kit	A192	No-Drip	A140
Screw Gun	A374	Bucket		Powerglide	A140
Black Duct Tape	A344	Boss Tool Carriers	A351	Sausage Pack	A140-A143
Black Edged Weatherstrips	A335	Seat Pro	A351	Vacuum Action	A140
Blades		Stacker Parts Tray	A351	Caulking Nozzles	A145
Adaptor	A191	Bulb Seal	A313-A315	Caulking Tube Nozzle Cutter	A144
Air Knife	A186-A193	Bulk Loading Caulking Gun	A140	Cavity Moldings	A339
Backglass Removal	A186, A445	Burco Redi Racks	A210	Center Punches	A371
BTB	A192-A193	Bus Windows	A499-A500	Cerium Oxide	A229, A231
Cold Knife	A169, A171	Bushings, Window Motor	A284	Channel	
Compact Knife	A367	Button Fastening Kit	A293	Autoglass	A322-A331
Cut-Out	A169, A171-A175, A186-A193, A196-A197, A199-A201	Butyl		Beaded Autoglass	A325-A327
Electric Knife	A196-A201	Autoglass Tapes	A124-A125	Chisel	A278
Equalizer	A190-A191, A199, A201	Dam Tape	A126	Cleaning Tool	A278, A328
Fein Knife	A188-A189, A196-A197	Sunroof Sealant Tape	A460	Door Glass Lift	A331
Hacksaw	A383	Bypass Kit, Power Window	A279	Driver	A277
Hot Knife	A172	C		Flexible Auto	A322-A323, A325-A331
Long Knife	A174-A175	“C” Clamps	A380, A447	Glass Run	A322-A331
Lubricant	A360	Cable Ties	A299	Glass Setting	A332-A333
Miter Saw	A382	Cables, Booster	A301	Liner	A345
Notching Saw	A357	Caddy, Insert Bit	A375	Marine	A327
Olfa Knife	A176	Camper Shell		Moldings	A338-A340
Oscillating	A186-A189, A191, A196-A197	Accessories	A447-A449	Rigid Auto	A324-A327, A331
Plastic Cutting	A379	Locks	A449	Unbeaded Autoglass	A322-A325, A328-A331
Plastic Razor	A153, A179	Props	A449	Channel and Vent Tool	A278
Powr-Cat Knife	A186-A187, A445	Top Rails	A448	Chargers, Battery Cartridge	A142-A143
Razor	A179, A353	Camper Windows	A496-A499	Chest, Portable Heating/Cooling	A115
Retractable Knife	A176, A366	Campermount Tape	A447	Chest, Tool	A349-A350
Scraper	A177-A179	Can, Organizer	A161	Chevy/GMC	
Stainless Steel Cut-Out	A169	Cap Accessories	A447-A449	Astro Van Windows	A480-A481
Stanley Pocketknife	A367	Cap Rack Legs and Rails	A448	Cowl Fasteners	A264-A265
Utility Knife	A176, A366	Car Protectors	A203	Door Trim Fasteners	A269-A271
Wildcat Knife	A186-A187, A445	Carbide		Locking Strip Tools	A310-A312
Windshield Knife	A169, A171-A175, A186-A193, A196-A197, A199-A201	Burr Drill	A225	Regulator Rollers	A284-A286
Windshield Wiper	A238	Glass Cutters	A355	Side-Slider Windows	A416
Blind Rivets	A291	Point Markers and Scribes	A371	Truck Sliders	A412-A418, A436
Blocks, Setting		Saw Blade	A382	Truck Sunroofs	A419
Sunroof Installation	A460	Carriers		Van Windows	A478-A482
Windshield Support	A126, A260	Tool	A352	Window Guides	A280-A281
Blowgun, Air Line	A194	Truck Bed	A208-A210	Windshield Molding Clips	A248-A249
Blue Windshield Tape	A343	Windshield	A208-A211	Chisel	
BMW Windshield Clips	A260	Cart, Service	A350	Channel	A278
Boat Windows	A498-A499	Carton Sealing Tape and Dispensers	A347	Scraper	A177, A353
Body-Cut Protection Garments	A393	Cartridge		Windshield	A172
Booster Cables	A301	Battery	A142-A143	Chromium Cleaner	A154
Bosch Unishear	A459	Grease	A163	Chrysler	
Bottle, Spray Dispenser	A149, A187	Guns	A134, A140-A143, A163	Cowl Fasteners	A265
Bottom Channel, Autoglass	A331	Heating Chests and Ovens	A115	Door Trim Fasteners	A268, A271-A272
Box Sealing Tape	A347	Holder	A144	Filler Strip Tool	A311



43AGR CATALOG A TO Z PRODUCT INDEX

Regulator Rollers	A284-A285	Connector		Polishing Oil	A360
Van Windows	A470	Cables	A299	POWR Clean Frit Kit	A111
Windshield Molding Clip Tool	A261	Crimping Tool	A300	POWR Cleaner	A111
Windshield Molding Clips	A247	Solderless	A300	POWR-Sliders	A405-A408, A410, A413-A415, A417, A421-A424, A429-A432, A435-A440
Cinch Windshield Repair Kits	A222	Contact Adhesive	A125	Razor Blades	A179, A353
Circuit Interrupt Box, Ground Fault	A301	Cooling Chests	A115	Retail Sales Support	A442
Circuit Tester	A301	Cordless		Sanding Bands	A364
Clamps		Caulking Guns	A142-A143	Scratch Polisher	A228
Spreader	A381	Cut-Out Tools	A199-A200	Side-Sliders	A409, A416
Spring	A381	Dremel Tool	A180, A225	Sliders for Trucks	A399-A441
Truck Cap	A447	Drills	A369	Silicone Sealants	A129-A131
Vise Grip	A380	Driver-Drills	A368	Silicone Spray	A160
Claw Pick-Up Tool	A274	Power Shears	A384	Solvent and Adhesive Cleaner	A201
Cleaners		Cords, Extension	A301	Sparkle Cleaner	A150, A226
Adhesive	A152	Cork Belts	A364	Sunroofs	A450-A455
All Purpose	A154-A155	Cotton Gloves	A391	Trim Securing Tape	A343
Aluminum	A154	Cotton Swabs	A114, A181	Tri-Vents	A405-A408, A410, A413-A415, A417, A421-A424, A429-A432, A435-A441
Armor-All	A154	Countersinks, Weldon	A371	Utility Knife Blades	A176, A366
Glass	A148-A150	Countersunk Washer Screws	A294, A297-A298	Van Windows	A466-A493
Hand	A156-A157	Countersunk Washers	A298	Wet Abrasive Belts	A361
Metal	A153-A154	Couplers, Air Tool	A195	Windshield and Body Sealant	A127
Plastic	A151	Covers		Windshield Knives	A168, A170, A172, A174-A175, A184-A185
Solvent	A152	Hood	A203	Windshield Sealants	A127
Sparkle	A150, A226	Seat	A147, A202	Windshield Setting Sticks	A312, A333
Vacuum	A385	Steering Wheel	A147, A202	Windshield Stands	A207
Clear		Cowl Fasteners	A263-A267	Windshield Wire	A182
Adhesive	A133, A236	Crack Pack Repair Kit	A217	Wipes, Glass Cleaner	A149, A158
Retention Tape	A342	Crack Resins	A217, A220, A223	Crystalene Resin	A223
Sealers, Automotive	A132	Crescent Wrench	A378	Crystolon Rubbing Bricks	A365
Silicones	A129-A131	Crimping Tools, Electrical	A300	Cup Holders	A495
Tapes	A348	CRL		Cups, Vacuum	A204-A206, A386-A387
Clear Vac		Abrasive Belts	A360-A361	Cure Guard	A216
Alignment Seals	A216	Aerosol Cleaners	A148, A151	Cushion Tape, Sponge Rubber	A346
Crack Pack Repair System	A217	Autoglass Primers	A111, A113	Custom Automotive Windows	A498-A500
Cure Guard	A216	Autoglass Silicone	A129	Custom Color Silicone	A130-A131
Flow Regulator	A216	Automotive Masking Tape	A342-A343	Cut-Out	
Injector Maintenance Kit	A216	Belt Sanders	A359, A362	Blades	A169, A171-A175, A186-A193, A196-A197, A199-A201
Injector Pump	A216	Big Rig Sliders	A427	Knives	A168-A175, A184-A193, A196-A201
Pedestals	A216	Bio-Clean Water Stain Remover	A150, A226	Wire	A182
Repair Resins	A217	Butyl Autoglass Tape	A124-A125	Cutters	
Re-Supply Kits	A215	Cork Belts	A364	Carbide Wheel	A355
Windshield Repair Kits	A212-A215	Duct Tape	A344	Glass	A354-A355
Clip Kits, Autoglass	A245	Duo-Vents	A406-A410, A414-A417, A422-A424, A427, A429, A431, A433-A434, A436-A441	Metal Handle	A355
Clip Tools for Doors	A273-A275	Electrical Tape	A347	Oil-Type	A354
Clip Tools for Windshields	A261	Glass Cleaners	A111, A148-A150	Plastic	A379
Clips		Glass Grinding Belts	A360	Self-Oiling	A354
Domestic Vehicle Molding	A245-A249	Glass Grinding Discs	A363	Wood Handle	A355
Import Vehicle Molding	A245, A250-A260	Hand Cleaner	A156-A157	Cutting Blades, Razor and Utility	A176, A366-A367
Weatherstrip	A336-A337	Hi-Bond Adhesive Tapes	A348		
Windshield and Backglass Molding	A245-A260	His 'N Hers Sunroofs	A455	D	
Clip-Zip Tool	A273	Hood Protectors	A203	Dam Tapes	A126
Cobalt Hacksaw Blades	A383	Impact Gloves	A388	Dash Protector	A175
Cobra Cut-Out Blades	A169	"L" Squares	A357	Datsun Truck Sliders	A432-A433
Coiled Air Hoses	A194	Masking Tape	A342-A344	Daubers for Autoglass Primers	A114
Cold Knives, Windshield	A168, A170, A173-A175, A191	Metal Cleaner	A154	Defroster Repair Kit and Accessories	A242-A243
Combination File and Brush	A383	Metal Lube	A160	Detector, Leak	A181
Commercial Service Cart	A350	Mirror Bracket Kits	A234	D-Flex Cut Resistant Gloves	A389
Compact Knife	A367	Mirror Bracket Tools	A237	Diamond	
Compressors, Air	A194	Pinch Weld Primer	A111, A113	Disc Pads	A231
Concave Vacuum Cup	A386	Pinch Weld Scraper Set	A177	Glass Drill Bit	A225
Concentrated Glass Cleaner	A149	Plastic Cleaner	A151	Grinding Bits	A364
Conductive Pen	A242	Pocket Ref	A167		
Connection Kit, Rear Defroster	A242				



43AGR CATALOG A TO Z PRODUCT INDEX

Hand Pads	A365	Drop Jaw Pliers	A366	Fein	
Saw Blade	A357	Drums, Sanding	A364	Blades and Scrapers	A188-A189, A196-A197
Tool Coolant	A357	Dry		Pneumatic Cut-Out Tool	A188
Whetstone Blade	A171	Cleaner Spray	A152	Saw Blades	A189, A197
Disc Sander Pads	A363	Graphite Lubricant	A162	Spanner Bolts	A198
Discs, Abrasive	A363	Pressurized Fire Extinguishers	A394	Windshield Knife and Blades	A188-A189, A196-A197
Discs, Polishing	A229, A231, A233	Dual Action Clamp/Spreaders	A381	Felt Polishers	A225, A229
Dispensers		Dual-Flex Wrist Supports	A392	Filament Tape	A347
Adhesive	A146	Dual Plunger Cartridge Gun	A134	File Card and Brush Combination	A383
Bottle	A149, A187	Duct Tape	A344	Files	A383
Glass Wipe	A158	Duo-Vent Truck Sliders		Filler Strip Insert Tools	A310-A312
Oil	A162	Big Rig	A427	Filler Strip, Windshield	A308-A309
Paper Towel	A158	Chevy/GMC	A414-A417, A436	Filter and Moisture Trap	A195
Tape	A347	Dodge	A422-A424, A437	Finder/Drivers	A375
Display, Windshield Repair	A224	Ford	A406-A410, A434	Finger Protective Wrap	A392
Disposable		International	A441	Fingerless Gloves	A392
Brush	A181	Isuzu	A433, A440	Fire Extinguishers	A394
Dust Masks	A394	Jeep	A441	First Aid Kits	A396
Gloves	A119, A391	Mazda	A431, A433, A440	Flat	
Respirators	A394	Mitsubishi	A433, A441	Head Phillips Screws	A296
Dissolvers	A152-A153	Nissan/Datsun	A433, A439	Jaw Metal Working Pliers	A380
Division Bar Weatherstrip	A315	Subaru	A433, A441	Washers	A298
Dodge		Toyota	A429, A433, A438	Flat-Rack Folding Glass Rack	A208
Cowl Fasteners	A265	Volkswagen	A433, A441	Fletcher Glass Cutters	A355
Door Trim Fasteners	A268, A271-A272	Duramix Static Mixer Nozzle	A134	Flexible	
Locking Strips and Tools	A309, A311-A312	Dust Masks	A394	Auto Channel	A322-A323, A325-A331
Truck Sliders	A420-A425, A437	E		Beaded Glass Run Channel	A325-A327
Truck Sunroofs	A426	Edger, POWR	A362	Claw Pick-Up Tool	A274
Van Windows	A471-A473	Elastic Strips	A396	Diamond Hand Pads	A365
Windshield Molding Clips	A247	Electric Power Shears	A384, A459	Edge Vacuum Cups	A386
Dome Light Wire	A300	Electric Power Shears	A384, A459	Foam Filler Door Trim	A319
Donuts, Rubber	A208	Electric Spoiler		Glass Run Channel	A322-A323, A325-A331
Door		Sunroof Accessories	A458	Magnetic Pick-Up Tool	A274
Clip Release Tool	A273-A275	Sunroof Replacement Parts	A458, A464	Weatherstrip	A334-A335
Glass Brackets	A277	Sunroofs	A456	Windshield Knife	A175
Glass Channel Cleaning Tool	A278, A328	Electric Truck Sliders	A405-A408, A410, A413-A415, A417, A421-A424, A429-A432, A435-A440	Flexx-Rap for Hands and Fingers	A392
Glass Lift Channel	A331	Electrical		Flocked Glass Run Channel	A329-A331
Glass Rollers	A285-A287	Crimping Tool	A300	Floor Mats	A147, A202
Glass Window Holders	A275, A279	Extension Cords	A301	Flow Regulator	A216
Handle Tools	A275	Tape	A301, A347	Foam	
Panel Fasteners	A268-A272	Terminals	A300	Core Butyl Tape	A124
Panel Removal Tools	A273-A274	Wire	A300	Dam Tapes	A126
Pulls, Van	A495	Emergency Escape Tool	A203	Door Trim	A319
Regulator Parts	A284-A287	End Cutting Nippers	A379	Latex Seal Weatherstripping	A318
Regulators, Window Replacement	A282-A283	EPDM/PVC Primers	A111, A113, A117-A118, A121, A123	Spacer Blocks, Sunroof	A460
Rivets	A288-A289	Epoxies	A135-A136, A138	Underside Molding	A340
Seal Weatherstrips	A318-A321	Equalizer Blades and Sheaths	A190, A201	Windshield Support Blocks	A126
Upholstery Remover	A276	Equalizer Tools	A190-A191, A199-A201	Foam Tapes	
Window Guides	A280-A281	Ergo-Fold Key Set	A376	Acrylic	A348
Windows for Vans	A490-A493	Ergonomic Windshield Cart	A211	Butyl Coated	A124
Dor-Tite Sponge Tape	A346	Essex Urethanes and Primers	A120-A121	Radius Window Seal	A495
Double		Excalibur Cut-Out Tool	A190	Windshield	A126
Lip QuickEdge Trim	A316	Extension Cords	A301	Folding	
Sided Adhesive Tape	A348	Extinguishers, Fire	A394	Glass Racks	A208
Sided Windshield Rack	A211	Extra Finger Tool	A262	Hex Key Sets	A376
Vacuum Cups	A206, A387	Extractor Cut-Out Tools	A191, A199	Windshield Stands	A207
Draco Inline Metal Shear	A384	Eye Protective Equipment	A203, A395	Work Seat	A207, A274
Dremel Tools and Accessories	A180, A225	F		Forceps, Heat Sink	A300
Dressing Stick	A171	Fast Cure Epoxy Cups	A136	Ford	
Drill Bits	A225, A370	Fast Cure Urethanes	A110, A112, A116-A118, A121-A122	Aerostar Windows	A477
Drill Gauge Set	A370	Fasteners		Cowl Fasteners	A263
Drills		Button and Socket Kit	A293	Door Trim Fasteners	A268, A270
Cordless	A225, A368-A369	Cowl	A263-A267	Regulator Rollers	A284, A286-A287
High Speed	A370	Door Trim Panel	A268-A272	Side-Slider Windows	A409
Unibits	A371	Remover Tools	A273, A275-A278	Truck Sliders	A404-A410, A434-A435
Variable Speed	A368	Trim	A268-A272	Truck Sunroofs	A410
Drip-Chek Sealer	A132	Upholstery	A293	Van Windows	A474-A476
Driver, Hex Nut Set	A376	Feature Line Moldings	A338, A340	Windshield Molding Clips	A245-A247
Driver, No-Krak Channel	A277			Form-A-Thread	A138
Driver/Drill Kits	A368			Fractional Gauge Drills Set	A370



43AGR CATALOG A TO Z PRODUCT INDEX

Fractional Wrench Set	A378
Freestanding Glass Rack	A211
Friction Tape	A344
F-Series Sliders	A405-A408, A434-A435
Fuzzy Duck PVC Gloves	A389

G

Gas Lift Props	A449
Gas Powered Compressor	A194
Gasket	
Cleaning Tool	A309
Installation Tool	A312, A411
Scrapers	A177
Silicone	A129
Gaskets, Pickup Truck Back Slider	A442
Gaskets, Sunroof	A461-A465
Gauge, Pressure Regulator	A194
Gauge, Surface Temperature	A217
Gears, Door Regulator	A284
General Purpose Adhesive Cleaner	A152
Genesis	
Sunroof Accessories	A458
Sunroof Replacement Parts	A463
Sunroofs	A454
Glas-Slip	A162, A306
Glass	
Bandage	A224
Breaking Pliers	A356
Carts for Windshields	A211
Cleaners	A111, A148-A150
Cleaning Wipes	A158-A159
Cutter Oil	A356
Cutter Pencil Pouch	A355
Cutters	A354-A355
Cutting L-Squares	A357
Grinding Belts	A360
Grinding Bits	A364
Handler Kit	A204
Handling Equipment	A204-A211, A386-A387
Handling Gloves	A388-A390
Jack	A204
Lift Channel	A331
Marking Pens	A357
Notching Saw	A357
Plate Repair Kit	A224
Pliers	A356
Polishers	A228
Polishing Belts	A364
Polishing Compound	A229
Primers	A111, A113, A117-A118, A121, A123
Run Channel	A322-A331
Sanders	A358-A359, A362-A363
Sanding Bands	A364
Sanding Belts	A360-A361
Sanding Discs	A363
Sanding Drums	A364
Sanding Sticks	A365
Seamer	A365
Setting Channels	A332-A333
Setting Tapes	A345
Slicker	A356
Sling Shot	A220
Stain Remover	A150, A226
Stop Rivets	A288
Storage Racks	A211
Sunroof Replacement	A461-A465
Surface Restoration	A226-A233
Surface Temperature Gauge	A217
Wipes	A149, A158-A159
Glassworker's Protective Gear	A388-A394

Gloves	
Atlas Fit	A389
Cotton	A391
Disposable	A391
Fingerless	A392
Fuzzy Duck	A389
Gauntlet Cuff	A390
Glass Handling	A388-A390
GripPro	A388
Impact	A202, A388, A390
Insulated	A390
Knit Fit	A388
Knit Wrist	A388-A391
Latex Coated	A389-A391
Leather	A391
Lint-Free Nylon	A391
Material Handling	A390-A391
Mechanix	A202, A390
Nitrile Disposable	A119, A391
Nylon	A391
PVC	A389
Rubber	A388, A390
Wrinkle Finish	A390
Glues	A138
Glycerine	A206
GMC	
Astro Van Windows	A480-A481
Cowl Fasteners	A264-A265
Door Trim Fasteners	A269-A271
Locking Strip Tools	A310-A312
Molding Clips	A245, A248-A249
Regulator Rollers	A284-A287
Truck Sliders	A412-A418, A436
Truck Sunroofs	A419
Van Windows	A478-A482
Window Guides	A280-A281
Windshield Molding Clips	A248-A249
Goggles	A395
Graphite	A162
Grease	
Cartridge	A163
Gun	A163
Remover	A152, A155
Green Windshield Tape	A342
Grime Scrub Brush	A157
Grinder, Bench	A382
Grinding Belts	A360-A361
Grinding Bits	A364
GripPro Impact Gloves	A388
Grip-Tite Handles	A183
Grommets	A209
Ground Fault Circuit Interrupter	A301
Guide, Template	A356
Guides, Window	A280-A281
Gun Fill Pump	A147
Guns	
Adhesive Applicator	A146-A147
Caulking	A140-A143
Dual Plunger	A134
Grease	A163
Rivet	A292
Rubber Seal	A146
H	
Hacksaws and Blades	A383
Hand	
Cleaners	A156-A157
Pads	A365
Seamer and Stones	A365
Towels	A158-A159

Handles	
BTB Blade	A193
Glass Sliding Window	A303
Grip-Tite	A183
RV and Camper Door	A449
Sunroof Replacement	A461-A465
Windshield Wire	A183
Handling Gloves	A388-A390
Headliner Tools	A275
Heat Sink Forceps	A300
Heated Urethane	A114, A116
Heating Chests	A115
Heavy Equipment Windows	A498
Heavy-Duty Glass Cutters	A354
Heavy-Duty Locking Strip Tool	A311
Hex	
Drivers	A375
Insert Bits	A374
Key Sets	A376
Key Wrench	A237, A373
Nut Driver Metric Set	A376
Screw Holders	A374
T-Handle Key Set	A376
Wrenches, Mirror Bracket	A237, A373
Hexagon Nuts	A298
Hi-Bond Adhesive Tapes	A348
High	
Modulus Urethanes	A113, A116, A118-A119
Speed Drills	A370
Speed Hacksaw Blades	A383
Temp Silicone Gasket	A129
Viscosity Urethane Adhesives	A110, A112, A117-A120, A122-A123
Hinges, Sunroof Replacement	A461-A463, A465
Hi-Shine Glass Cleaner	A148
His 'N Hers Sunroof	A455
His 'N Hers Sunroof Replacement Parts	A463
Holder, Razor Blade	A178
Holders, Door Glass Window	A275, A279
Honda	
Cowl Fasteners	A266-A267
Trim Panel Fasteners	A272
Windshield Molding Clips	A253-A259
Hood Protectors	A203
Hook Blades	A176, A187, A189, A196
Hook Tools	A312
Horizontal	
Bulb Seal	A314-A315
Half Sliders	A485, A492-A493
Wedge Seal	A314
Horse Trailer Windows	A496-A497
Hoses, Air Tool	A194
Hot Air Gun	A341
Hot Knife and Blades	A172
Hydraulic Rivet Gun	A292
Hyundai Windshield Molding Clips	A259
I	
Impact Driver/Drill Kit	A368
Impact Gloves	A388
Import Locking Strip Tools	A310
Import Truck Sliders	A428-A433, A440-A441
Injector	
Maintenance Kit	A216
Pump	A216
Syringes for Resins	A219
Inline	
Blowgun	A194
Metal Shear	A384
Moisture Trap and Oiler	A195



43AGR CATALOG A TO Z PRODUCT INDEX

Insert					
Bits and Holders					
Moldings		A338-A341			
Tool, Rear Slider		A446			
Tool, Retainer Clip		A446			
Tools, Headliner		A275			
Tools, Locking Strip		A310-A312			
Inspection Cup with Mirror		A220			
Installation Tools for Gaskets		A306, A312			
Installation Video, Truck Slider		A442			
Instant Adhesives		A137			
Insulated Glass Handling Gloves		A390			
Insulated Solderless Splice Connectors		A300			
International Truck Slider		A441			
Inverters, Power		A299			
Isuzu Truck Sliders		A431-A433, A440			
J					
Jack, Glass		A204			
Jackets, Kevlar		A393			
Japanese Car					
Clip Kits		A245			
Cowl Fasteners		A265-A267			
Regulators with Motors		A282-A283			
Windshield Clips		A250-A259			
Jeep Cherokee Sunroof		A455			
Jeep Truck Sliders		A441			
K					
Kennedy Tool Boxes and Chests		A349-A350			
Kett Shears		A384, A459			
Kevbest Protective Sleeves		A393			
Kevlar Jackets		A393			
Kevlar Protective Leg Chaps		A393			
Key and Bracket Wrenches		A237, A373			
Kimberly-Clark					
Hand Cleaner		A157			
Hand Wipes		A156			
Shop Towels		A159			
Kits					
Aegis Windshield Repair		A218-A219			
Cold Knife		A168			
Plastic Rivet		A245			
Power Window Bypass		A279			
Reveal Molding Clips		A245			
Screw		A294			
Windshield Repair		A214-A215, A218-A219, A222			
Klik Split Rivets		A288			
Knife					
Air Cut-Out		A184-A185, A188, A190-A192			
Banana		A175			
Blade Adapter		A191			
Blades, Utility		A176			
Cold		A168, A170, A191			
Equalizer		A190-A191, A200			
Fein		A188, A196			
Flexible		A175			
Kit, Autoglass		A173			
Long		A174-A175			
Multi-		A173			
Ninja		A191			
Offa		A176, A367			
Oscillating		A184-A185, A188, A191			
Pipe Handle		A173			
Pocket		A367			
POWR-Cat		A184, A444			
Push Button		A168			
Quickknife		A173			
Razor Blade		A367			
Retractable		A366			
Rigid Aluminum		A175			
Scalloped Edge		A175			
Sport		A367			
Super Grip Aluminum		A175			
Super Hot		A172			
Sur-Grip		A174			
Swivel-Lock		A366			
U-Blade		A173			
UltraWiz		A170			
Utility		A366-A367			
Wildcat		A185, A444			
Knit Fit Gloves		A388			
Knit Wrist Gloves		A388-A391			
Krytox Lubricant		A162			
Kwik Change Tool Box		A352			
L					
"L" Cut-Out Blades		A186, A188, A197			
L-Squares		A357			
Latches, Pickup Slider		A443			
Latches, Sunroof		A461-A463			
Latex Foam Weatherstripping		A318			
Latex Rubber Gloves		A391			
Leak Detector		A181			
Leather Gloves		A391			
Leg Protectors		A393			
Lenses, Rain and Light Sensor		A239, A241			
Lever Action Cold Knife		A170			
Lexus Cowl Fasteners		A266			
Lexus Windshield Molding Clips		A252			
Lift Off Removers		A155			
Light Sensors		A239-A241			
Lint-Free Nylon Gloves		A391			
Lint-Free Wipes		A111, A158			
Lip Seal		A313, A315			
Lithium Grease		A163			
Load Rails		A448			
Lock Washers		A298			
Locking Strip Insert Tools		A310-A312			
Locking Strips		A308-A309			
Locks, RV and Camper Door/Window		A449			
Loctite					
Contact Adhesives		A125			
Epoxy, Clear		A135			
Epoxy Cups		A136			
Fast Cure Epoxy		A136			
Form-A-Thread		A138			
Minute Bond		A137, A236			
Mixer Cups		A136			
Plastic Bonder		A138			
Poxy-Pak Clear Two-Part		A135			
Primer, Minute Bond		A137, A236			
Prism Adhesives		A137			
Rear View Mirror Adhesive		A236			
Super Bonder		A137, A236			
Threadlocker Stick		A138			
Long					
Crack Repair Kit		A219			
Crack Tape		A219			
Knives		A174-A175			
Leg Single Lip Trim		A317			
Reach Door Panel Removal Kit		A274			
Loosener and Penetrant		A160			
Low Viscosity Repair Resin		A220, A223			
Low Voltage Circuit Tester		A301			
Lubricants					
Air Tool		A195			
Dry Graphite		A162			
Glas-Slip		A162			
Metal		A160			
Pro-2		A160			
Rubber		A162, A306			
Silicone Spray		A160-A161			
Spray Penetrant		A160			
Tube Wax		A163, A360			
WD-40		A160			
White Grease		A163			
M					
Machinist Apron		A394			
Magnetic					
Clip Insertion Tool		A446			
Hex Head Screw Holders		A374			
Insert Bit Holders		A374			
Pick-Up Tool		A274			
Screwdrivers		A372			
Shaft, Flexible		A274			
Magnum Equalizer Knives		A200			
Makita					
Angle Drills		A369			
Backup Pads		A363			
Belt Sanders		A358-A359			
Cordless Driver-Drills		A368-A369			
Disc Sander/Polishers		A363			
Electric Drill		A369			
Finder/Driver		A375			
Finishing Sander		A363			
Miter Saw		A382			
Portable Sanders		A358-A359			
Scratch Polisher Kit		A228			
Mallet, Persuader		A172			
Marine Glass Run Channel		A327			
Marking Pencils and Pens		A357			
Marson Rivet Gun		A292			
Masking Tape					
Automotive		A342-A343			
Dispenser		A347			
Multi-Purpose		A344			
Masks, Dust		A394			
Mast Extensions and Tubing		A210			
Material Handling Gloves		A390-A391			
Mats, Floor		A147, A202			
Mazda Truck Sliders		A431-A433, A440			
Mazda Windshield Molding Clips		A259			
Mechanix Wear Gloves		A390			
Measurement Guide/Van Windows		A468-A469			
Measuring Tapes		A353			
Medium Viscosity Repair Resin		A220			
Medium Viscosity Urethanes		A112, A118-A122			
M.E.K.		A153			
Mercury Windshield Molding Clips		A246, A259			
Metal					
Cleaners		A153-A155			
Cutting Nibbler		A382, A459			
Handle Glass Cutter		A355			
Lube		A160			
Working Pliers		A380			
Methyl-Ethyl-Ketone		A153			
Metric					
Nut Driver Set		A376			
Socket Wrench Set		A377			
Wrench Sets		A377			
Micro Fiber Wipes		A158			
Mildew Resistant Silicones		A130-A131			
Milwaukee Caulking Guns		A143			
Milwaukee Drill		A369			
Mini-Mite Cordless Rotary Tool		A180, A225			
Mini Scraper		A178			
Minitrim, QuickEdge Trim		A317			
Minivan Windows		A473, A477, A480-A481			



43AGR CATALOG A TO Z PRODUCT INDEX

Minute Bond Primer	A137, A236
Minute Bond Rear View Mirror Adhesive	A137, A236
Mirror	
Bracket Repair Kit	A234
Bracket Tools	A237
Bracket Wrenches	A237, A373
Brackets	A234-A235
Inspection	A220
Notching Saw	A357
Rear View Replacement	A236
Stick-On Convex	A237
Miter Saw	A382
Mitsubishi Windshield Molding Clips	A254
Mitsubishi Truck Sliders	A432-A433, A441
Mohair Channel Liner	A345
Moisture Trap for Air Tools	A195
Molded Sponge Rubber Weatherstrip	A319-A321
Molding	
Adhesive	A339
Cavity	A339
Channel	A338-A340
Clip Kits	A245
Clips, Windshield	A246-A260
Foam Underside	A340
Glass Run Channel	A331
Installation Tool	A340
Removal Blade	A171
Specimen Chain	A339
Tools	A261-A262
Underside	A340
Universal Channel	A338-A339
Windshield Trim	A338-A341
Moleskin Channel Liner	A345
Motor Bushing Kit	A284
Motor Home Windows	A496-A498
Motors, Window Replacement	A282-A283
Mounting Legs for Load Rails	A448
Multi-Bulb Seal	A315
Multi-Cutter	A309, A339
Multi-Purpose Masking Tape	A344
Multi-Spanner	A276
Multi-Wedge Pry and Level Tool	A381
Music Wire	A182
Mylar Squares	A220

N

NAGS Air Bag Reference Guide	A167
Nail Remover	A276
Neck Saver	A202
Needlenose Pliers	A379
Neutral Cure Silicone Sealant	A129-A130, A460
NewPort	
Sunroof Accessories	A458
Sunroof Replacement Parts	A462
Sunroofs	A453
Nibbler Cutting Tool	A382, A459
Ninja Cut-Out Knife	A191
Nippers, End Cutting	A379
Nissan	
Cowl Fasteners	A266-A267
Truck Sliders	A430, A432-A433, A439
Windshield Molding Clips	A257
Nitrile Disposable Gloves	A119, A391
No-Krak Channel Driver	A277
Non-Conductive Urethanes	A110, A113, A116, A118
Novus Plastic Polishes	A151
Noxon Centerpunch	A371
Nozzle Caps	A145
Nozzle Cutter	A144

Nozzles	
Mixing	A134-A135
POWR 300 Series	A145
Pre-Cut	A145
Problem Solver	A145
Standard Tip Screw-On	A145
Two-Part Mixer	A134-A135
Urethane	A145
Nut	
Driver Set	A376
Removal Tools	A276
Stamped with Sealer	A298
Nylon Ties	A299
Nylon Wrist Protectors	A392
O	
OEM Custom Windows	A498-A500
Offset	
Hex Bit Driver	A375
Molding Blade	A171
Screwdrivers	A373
Snips	A379
Oil	
Air Tool	A195
Glass Cutters	A354-A356
Glass Cutting	A356
Pneumatic Tool	A195
Polishing	A161, A360
Oiler Can	A162
Oiler, Inline	A195
Oldies Sliders	A427
One-Piece Self-Sealing Weatherstrip	A304-A306
Orange Windshield Tape	A342
Organizer, Aerosol Can	A161
Organizer, Urethane Cartridge	A144
Oscillating Cut-Out Blades	A186-A189, A191, A196-A197
Oscillating Knife Blade Adapter	A191
Oscillating Knives	
Equalizer	A191
Fein	A188, A196
POWR-Cat	A184
WildCat	A185
Oval Head Phillips Screws	A294-A295, A297-A298
Oversize Bulb Seal	A314

P

Pads, Diamond Hand	A365
Pads, Disc	A363
Paint	
Prep Pen	A181
Remover	A155
Scrapers	A177-A178
Pan Head Phillips Screws	A294, A296-A297
Panel, Door Removal Tools	A273-A274
Panel Fasteners	A268-A272
Paper Towels	A158-A159
Parts Cabinets and Organizers	A350
Parts, Sunroof Replacement	A461-A465
Pen	
Adhesive Remover	A153
Conductive	A242
Glass Marking	A357
Humidity/Temperature	A181
Paint Prep	A181
Pencil Pouch	A355
Pencils, Glass Marking	A357
Perfect Fit Truck Sliders	A402-A403
Persuader Urethane Chisel	A172
Phenolic L-Squares	A357
Phenolic Straight Edges	A357

Phillips	
Bits, Insert	A374
Screwdrivers	A373
Screws	A294-A298
Piano Wire	A182
Pickup Truck	
Accessories	A442-A443
Glass Racks	A208-A211
Rear Sliders	A399-A441
Replacement Gaskets	A442
Windshield Racks	A208-A211
Pick-Up Tools, Flexible	A274
Pinchtop Single Lip Trim	A317
Pinchwell	
Primers	A111, A113, A117-A118, A121, A123-A124
Scrapers	A177
Pipe Handle Cut-Out Knife	A174
Pistol Type Oiler Can	A162
Pit Fill Repair Kit	A218
Pit Fill Resins	A217, A223
Plastic	
Bonders	A137-A138
Brackets, Door Glass	A277
Cleaners	A151, A154
Cutting Blades	A153
Cutting Tools	A379
Drive Rivet Kit	A245
Fastener Removal Tool	A273
Polish	A151
Razor Blades	A179
Rivets	A290
Scraping Tool	A153
Spray Bottle	A149, A187
Stick Tools	A312
Trim Snips	A379
Window Washer Holder	A277
Windshield Stick Holder	A312
Plate Glass Repair Kit	A224
Plexi-Dome Roof Vent	A494
Pliers	
Curved Jaw	A380
Diagonal	A379
Glass Running	A356
Latch Pin Removal	A277
Long Nose	A380
Metal Working	A380
Needlenose	A379
Rib Joint	A379
Short Nose	A379
Straight Jaw	A380
Vise Grip	A380
Window Guide	A281
Plymouth Locking Strip Tool	A312
Plymouth Windshield Molding Clips	A247, A259
Pneumatic Cut-Out Tools	A184-A185, A188, A190-A192
Pocket	
Driver, 6-in-1	A373
Knives	A367
Reference Book	A167
Polish, Plastic	A151
Polish, Stainless Steel	A155
Polisher	
Cork and Felt Wheel	A228
Disc	A363
Scratch	A227-A228, A230-A233
Polishing	
Belts	A364
Compound	A229, A233
Discs	A231, A233
Head Assemblies	A229



LOG ON TO crlaurence.com FOR BUSINESS-TO-BUSINESS SERVICES

A510 | PHONE (800) 421-6144 | FAX (800) 262-3299 TOLL FREE FROM ANYWHERE IN THE U.S.A. OR CANADA

43AGR CATALOG A TO Z PRODUCT INDEX

Oil	A161, A360	Seat	A147, A202	Rollers	A285-A287
Pads	A229, A231	Steering Wheel	A147, A202	Window Replacement	A282-A283
Systems	A228-A233	Wrist	A392	Release Agents	A152
Wheels	A229, A233	Pry Bars	A177, A353	Remover	
Portable		Pry/Level Multi-Wedge Tool	A381	Adhesive	A152-A153
Air Tank	A194	Pump Guns	A146-A147	Door Panel	A273-A274
Hot/Cold Chests	A115	Pumper, Equalizer	A202	Door Upholstery	A276
Sander Belts	A360, A364	Pumps, Adhesive	A146-A147	Dust	A153
Sanders	A358-A359	Push Button Cold Knife	A168	Glass Scratch	A227-A233
Windshield Stand	A207	Push-In Retainer Kit	A245	Molding	A261
Portholes for Vans	A494	Putty Tape	A346	Upholstery Nail	A276
Pouch, Glass Cutter	A355	PVC Gloves	A389	Water Spot	A150, A226
Pouch, Tool	A351			Windshield Wiper Arm	A262
Power		Q		Replacement	
Inverters	A299	Quad Rings	A220	Alignment Seals	A216
Window Bypass Kit	A279	Quart Cartridge Caulking Gun	A143	Clip Kits	A245
Window Drive Tape	A285	Quarter Window Weatherstrip	A315	Gaskets, Rear Slider	A442
Window Gears	A284	QuickBlade Utility Knife	A366	Hardware, Sunroof	A461-A465
Window Motors and Regulators	A282-A283	Quick Cure Urethanes	A110, A112, A116, A119-A120	Latches, Rear Slider	A443
Powerpull Cold Knife Grip	A169	Quick Cure UV Resin	A217	Pedestals	A216
POWR-Cat Cut-Out Knife	A184, A444	QuickEdge Trim	A316-A317	Rear View Mirrors	A236
POWR Clean Frit Kit	A111	Quick-Grip Clamp/Spreader	A381	Regulators/Motors	A282-A283
POWR Cleaner	A111	QuickKnife	A173	Shroud Seals	A233
POWR Edger	A362	Quick Release Agent	A152	Sunroof Parts	A461-A465
Powr-Grip Vacuum Cups	A205, A386	Quick-Snap Rivets	A291	Ultraviolet Bulb	A221
POWR Primerless Urethanes	A112-A113	Quik Kit, Aegis	A219	Replacement Blades	
POWR-Sliders		QuikSteel Epoxy Putty	A138	BTB Knife	A192-A193
Chevy/GMC	A413-A415, A417, A436			Cold Knife	A169, A171, A191, A445
Dodge	A421-A424, A437	R		Express Tool	A199
Ford	A405-A408, A410, A435	Racks		Extractor Tool	A199
Isuzu	A431-A432, A440	Glass Storage	A211	Hot Knife	A172
Mazda	A431-A432, A440	Mobile Auto	A208-A210	Long Knife	A174-A175
Nissan	A430, A432, A439	Roll-Out	A209	Multi-Knife	A173
Toyota	A429, A432, A438	Windshield	A208-A211	Olfa	A367
Pre-Cut Nozzles	A145	Radians Safety Eye Wear	A395	Oscillating Knife	A186-A189, A191, A196-A197
Primers		Rain and Light Sensors	A239-A241	Pinch Weld Scraper	A177
EPDM/PVC	A111, A113, A117-A118, A121, A123	Ratchet Screwdrivers	A372	Pipe Handle Knife	A176
Minute Bond	A137, A236	Ratchet Wrenches	A378	Razor Scraper	A179
Pinch Weld	A111, A113, A117-A118, A121, A123-A124	Razor Blades		Reciprocal Knife	A190, A200-A201
POWR Primerless	A113	Double Edge	A153, A179	Retractable Knife	A176, A367
Sika	A117	Heavy-Duty	A179	Serrated Edge	A176
3M	A123	Holders	A178	U-Blade Knife	A173
Titan	A119	Knife	A367	Utility Knife	A176, A366
Prism Adhesives	A137	Plastic	A153, A179	Resin Injector Syringes	A219
Private Label Glass Cleaner	A148	Scrapers	A178, A353	Resins, Windshield Repair	A217, A220, A223
Pro Series Extractor	A191	Single Edge	A179, A353	Respirators	A394
Pro-Snip Offset Snips	A379	Ready Jet Inline Blowgun	A194	Re-Supply Kits, Clear Vac	A215
Pro-2 Silicone Spray	A160	Ready-Mix Glass Cleaner	A149	Retail Sales Support	A442
Problem Solver Nozzles	A145	Rear		Retaining Nut Tool	A276
Props for Camper Door	A449	Deck Sponge Rubber	A320-A321	Reusable Caulk Tips	A144
Protect-A-Dash	A175	Defroster Repair Kits	A242-A243	Reveal Molding	
Protective		Glass Gaskets	A442	Back Cut Tool	A173
Apron	A394	Slider Installation Tools	A446	Clip Kits	A245
Back Belt/Suspenders	A392	Sliders for Pickups	A399-A441	Clip Tools	A261
Body-Cut Garments	A393	Window Grid Repair Kit	A242	Replacement Clips	A246-A260
Dust Masks	A394	Rear View Mirror		Screws	A245, A298
Eye Wear	A395	Adhesives	A236	Rez-Guard Barrier Cream	A157
Garments	A393	Bracket Removal Iron	A237	Rigid	
Glasses	A395	Brackets	A234-A235	Auto Channel	A324-A327, A331
Gloves	A202, A388-A392	Hang Tags	A119	Urethane Knife	A175
Goggles	A395	Installer Tool	A237	Weatherstrips	A335-A336
Hand and Finger Wrap	A392	Release Tools	A237	Rivet	
Leg Chaps	A393	Replacements	A236	Guns	A292
Respirators	A394	Red Gasket Silicone	A129	Head Removal Tools	A291
Sleeves	A389, A393	Reference Book	A167	Setter	A292
Spectacles	A395	Regulator		Spacers	A291
Weight Belt	A392	Gears, Window	A284	Tools	A292
Protectors		Nut Tools	A276	Rivet Eater	A291
Car Hood	A203	Pressure	A194		
Floor	A147, A202	Rivets	A288-A289		



43AGR CATALOG A TO Z PRODUCT INDEX

Rivets			
Aluminum	A288-A289, A291		
Automotive	A288-A290		
Blind	A291		
Door Glass	A287-A288		
Door Handle	A288		
Door Weatherstrip	A289		
Glass Stop	A288		
Lower Channel	A289		
Nylon	A290		
Plastic	A245, A290		
Quick-Snap	A291		
Steel	A289, A291		
Vent Pivot	A289		
Window Regulator	A288-A289		
Roll-Out Windshield Rack	A209		
Rolled Glass Run Channel	A328		
Roller Nut Tools	A276		
Rollers, Automotive Door	A285-A287		
Rolling Tool Box	A350		
Rolling Windshield Cart	A211		
Roloc Bristle Discs	A180		
Roof Rail Weatherstrip	A321		
Roof Vents, Van	A494		
Rotating Head Rivet Gun	A292		
RTV Silicones	A129-A131		
Rubber			
Auto Weatherstrip	A318-A321, A332-A333		
Channels	A332-A333		
Coated Gloves	A388-A390		
Conditioning Glycerine	A206		
Donuts	A208		
Gasket Cleaning Tool	A309		
Glass Setting Channels	A332-A333		
Lubricant	A162, A306		
Molded Sponge Weatherstrip	A319-A321		
Seal Adhesive Gun	A146		
Strips, Truck Bed	A209		
Vacuum Cup	A205		
Weatherstrip, Self-Sealing	A302-A308		
Rubbing Bricks	A365		
Rust Prevention Tools	A180-A181		
RV Door Locks	A449		
RV Windows	A483, A496-A499		
S			
Safety			
Edge Trim	A317		
Equipment and Supplies	A388-A396		
Eye Wear	A203, A395		
Gloves	A388-A392		
Goggles	A395		
Sanders			
Disc	A363		
Portable Belt	A358-A359, A363		
Upright Belt	A359, A362		
Sanding			
Bands	A364		
Belt Lubricants	A161, A163, A360		
Belts	A360-A361		
Discs	A363		
Drums	A364		
Sticks	A365		
Saturn Roller Nut Wrench	A276		
Sausage Pack Caulking Guns	A140-A143		
Saw Blades			
Carbide Tipped	A382		
Circular	A189		
Diamond Tile	A357		
Glass Cutting	A357		
Hacksaw	A383		
Miter Saw	A382		
Saws			
Hacksaw	A383		
Mirror Notching	A357		
Miter	A382		
Scalloped Windshield Knife	A175		
Scotch Adhesive Remover Pen	A153		
ScotchLok Auto-Taps	A300		
Scrape and Pry Bar	A177, A353		
Scraper			
Blades	A177-A179, A189		
Chisel	A177		
Pinchweld	A177		
Plastic	A153		
Razor Blade	A178		
Windshield	A178		
Scratch Awl	A375		
Scratch Polishers and Accessories	A227-A233		
Scratch-A-Way Glass Repair System	A227		
Screw Gun Bits and Holders	A374-A375		
Screwdrivers			
4-In-1	A372		
6-In-1	A373		
Extension	A372		
Insert Bits	A374		
Magnetic	A372		
Offset	A373, A375		
Phillips	A372-A373		
Ratchet	A372		
Slotted	A373		
Screws			
Automotive	A294-A298		
Black	A297		
Chrome	A294-A298		
Countersunk Washer Head	A294, A297-A298		
Fix-Kits	A294		
Flat Head Phillips	A296		
Oval Head Phillips	A294-A295, A297-A298		
Pan Head Phillips	A294, A296-A297		
Reveal Molding	A245, A298		
Self-Drilling	A294, A297-A298		
Specialty	A298		
Tapping	A294-A297		
Van Window	A495		
Washer Head Tek	A297		
Weatherstrip Rail	A298		
Scrub Brush	A157		
Scrubs-In-A-Bucket	A156		
Sealants			
Auto Polyurethane	A132		
Autoglass Resealant	A127-A128		
Autoglass Silicone	A129		
Autoglass Urethanes	A110, A112-A114, A116-A123		
Butyl Autoglass	A127-A128		
Silicone	A129-A131, A460		
Sealers			
Automotive	A132		
Drip-Chek	A132		
Windo-Weld	A132		
Seals, Neoprene	A313-A315		
Sealstrip Tape	A345		
Seamer, Hand Glass	A365		
Seat			
Belts	A495		
Covers, Disposable	A147, A202		
Folding Work	A207, A274		
Self-Sealing Weatherstrips	A302-A309		
Self-Sealing Weatherstrip Locking Tools	A306, A310-A312		
Sensors, Rain and Light	A239-A241		
Setting			
Blocks, Windshield	A260		
Channels	A332-A333		
Stick	A206		
Tapes	A345		
Tool, Windshield	A312, A333		
Seven Drawer Tool Chest	A350		
SFC/CRL Sunroofs	A450-A459		
Shank Adapter for Disc Pads	A229, A231		
Shears, Metal	A384		
Sheath			
Cleaner	A190, A201		
Equalizer Blade	A190, A201		
Utility Knife	A366		
Shop Towels	A159		
Shop Vacuums	A385		
Shoulder Bulb Seal	A315		
Shroud Seals	A233		
Side Window Vise	A279		
Side-Sliders for SUV's	A409, A416		
Sidewinder Cut-Out Wire	A182		
Sika			
Aktivator	A117		
Primers	A117		
Urethanes	A116-A117		
Silicon Carbide Belts	A360-A361		
Silicone Spray	A160		
Silicones			
Acetoxy Cure	A131		
Autoglass Gasket	A129		
Autoglass Sealant	A129		
Building Sealant	A130		
Cleaner and Surface Prep	A153		
Custom Color	A130-A131		
Mobile Home Fabrication	A130		
Neutral Cure	A129-A130, A460		
Non-Acetic	A130		
Red Gasket	A129		
RTV	A121-A131		
Single			
Edge Razor Blades	A179, A353		
Lip Trim	A317		
Sided Windshield Rack	A211		
Step Primer	A123		
Sleeves, Protective	A389, A393		
Slicker, Glass	A356		
Slider			
Accessories	A442-A443		
Application Charts	A434-A441		
Buddy Tool	A446		
Installation Kit	A446		
Slider and Sunroof Display Stands	A442		
Sliders			
All Glass Look	A405		
Big Rig	A427		
Chevy/GMC Trucks	A412-A418, A436		
Datsun Trucks	A432-A433		
Dodge Trucks	A420-A425, A437		
Ford Trucks	A404-A410, A434-A435		
Import Trucks	A428-A433, A440-A441		
International Trucks	A441		
Isuzu Trucks	A431-A433, A440		
Mazda Trucks	A431-A433, A440		
Mitsubishi Trucks	A432-A433, A441		
Nissan Trucks	A430, A432-A433, A439		
Oldies	A427		



43AGR CATALOG A TO Z PRODUCT INDEX

Perfect Fit	A402-A403	Stain Remover, Water	A150, A226	Blue Windshield	A343
Specialty	A427	Stainless Steel		Butyl Autoglass	A124-A125
Subaru Trucks	A433, A441	Beaded Weatherstrip	A334-A335	Campermount	A447
SUV	A409, A416	Cold Knife Blades	A169	Carton Sealing	A347
Toyota Trucks	A429, A432-A433, A438-A439	Compact Knife	A367	Cork and Rubber	A345
Volkswagen Trucks	A433, A441	Cut-Out Wire	A182	Dam	A126
Sliding Sunroofs	A456	Locking Strip Tool	A311	Dispensers	A347
Sliding Windows		Polish and Cleaner	A155	Dor-Tite	A346
Busses	A499-A500	Stands, Display	A442	Duct	A344
Campers	A496-A499	Stands, Windshield	A207	Elastrometric Drive	A285
Commuter Vans	A499-A500	Stanley		Electrical	A301, A347
Horse Trailers	A496-A497	Adjustable Wrench	A378	Filament	A347
Minivans	A473, A477, A480-A481	Pocket Knife	A367	Foam Core Butyl	A124
Motorhomes and RV's	A496-A498	Ratchet Screwdrivers	A373	Foam Dam	A126
Pickup Trucks	A399-A441	Utility Knives	A366	Foam Windshield	A126
Shuttle Busses and Vans	A499-A500	Steering Wheel Covers	A147, A202	Friction	A344
SUV	A409, A416	Step Drills	A371	Guides	A285
Trailers	A496-A497	Stick		Hi-Bond Manufacturing	A348
Vans	A466-A493	Holder	A312	Kits, Autoglass	A124-A125
Slip-N-Grip		Sanding	A365	Long Crack	A219
Floor Mats	A147, A202	Threadlocker	A138	Masking	A342-A344
Seat Covers	A147, A202	Wax	A163, A360	Molding	A342-A343
Steering Wheel Covers	A147, A202	Windshield	A312	Multi-Purpose Masking	A344
Slotted Screwdriver Insert Bits	A374	Windshield Setting	A206	Putty	A346
Slotted Screwdrivers	A373	Stick-On Convex Mirror	A237	Rules	A353
Smart Glue Epoxy Gel	A138	Stick-On Sanding Discs	A363	Sealstrip	A345
Snips, Plastic Trim	A379	Straight Edges, Phenolic	A357	Sunroof Sealant	A460
Socket Wrench Sets	A377	Strip-Calk	A125	Transparent/Translucent Adhesive	A348
Solderless Connectors and Terminals	A300	Stripe Adhesive Remover	A152	Trim Securing	A342-A343
Solvents	A152-A153	Subaru Truck Sliders	A433, A441	Tuff-Pak	A345
Spacer Blocks, Sunroof	A460	Suck-n-Clamp	A262	Weatherstripping	A346
Sparkle Cleaner	A150, A226	Suction Cups	A204-A205, A386-A387	Windshield Molding	A342-A343
Specialty Truck Sliders	A427	Sunroof		Windshield Securing	A126
Spectacles	A395	Accessories	A457-A459	Wonder	A346
Sponge Rubber Weatherstripping	A319-A321	Butyl Sealant Tape	A460	Tape Control Window Regulator Parts	A285
Sponge Rubber Weatherstripping Tape	A346	Installation Products	A459-A460	Tapping Screws	A294-A298
Sport Utility Knife	A367	Replacement Parts	A461-A465	Cut-Out Blades	A169
Spray		Spacer Blocks	A460	Tek Screw Kit	A294
Adhesive Remover	A152, A155	Storage Bags	A457	Terminal Kits, Solderless Electrical	A300
Adhesives	A139	Sunshades	A458	Temperature Gauge, Glass Surface	A217
Bottle	A149, A187	Templates	A459	Template Guide	A356
Cleaners	A148, A151-A152	Wind Deflectors	A457	Templates, Flexible Shape	A356
Degreaser/Solvent Cleaner	A152	Sunroofs		Templates, Sunroof	A459
Dry Cleaner	A152	AutoPort	A452	Test Lamp Kit	A243
Glass Cleaner	A148	Chevy/GMC Truck	A419	Tester, Low Voltage Circuit	A301
Lubricants	A160-A161	Dodge Truck	A426	Three Drawer Tool Boxes	A349-A350
Paints	A460	Electric Spoiler	A456	3M	
Penetrant	A160	Ford Truck	A410	77 Spray Adhesive	A139
Plastic Cleaner	A151	Genesis	A454	Adhesive Cleaner and Remover	A152
Release Agent	A152	His 'N Hers	A455	Adhesive Remover Pen	A153
Sprayway		Jeep Cherokee	A455	Auto Bedding and Glazing Compound	A125, A128
All Purpose Cleaner	A155	NewPort	A453	Auto Glass Urethane	A122
Auto Care Instant Shine	A155	Super		Auto-Mix Adhesive	A135
Clean Up Dry Cleaner	A152	Bondor Adhesive	A137, A236	Automotive Adhesives	A229
Degreaser/Solvent	A152	Trim Adhesive	A139	Automotive Masking Tape	A342-A343
Dry Lubricant	A161	Weatherstrip Adhesive	A133, A229, A319	Automotive Sealer	A132
Dust Remover	A153	Surface Protector	A150	Butyl Autoglass Tape	A125
Glass Cleaner	A148	Surface Restoration Systems	A226-A233	Clear Auto Sealer	A132
Glass Cleaner Wipes	A149	Suspenders, Back Belt	A392	Diamond Hand Pads	A365
Jet Clean 100	A153	Swivel-Lock Utility Knife	A366	Door Glass Adhesive	A135
Private Label Aerosols	A148	Syringes, Resin Injection	A219	Drip-Chek Sealer	A132
Spray Adhesive	A139	T		Fast Cure Urethane	A122
Stainless Steel Polish and Cleaner	A155	T-Handle Hex Key Set	A376	Fast Tack Trim Adhesive	A133
Spring Clamps	A381	T-Handle, Truck Cap	A449	Flow Grade Butyl Sealant	A128
Square Windshield Cut-Out Wire	A182	T-Sliders, Van Bay Window	A487, A492	General Purpose Adhesive Cleaner	A152
Squares, "L"	A357	Tape		Plastic and Emblem Adhesive	A133
Squeeze Tube Silicone Sealant	A129	Acrylic Hi-Bond	A348	Release Agent	A152
Squeeze Wrench Set	A377	Adhesive	A348	Roloc Discs	A180
SRP Scratch Remover System	A232-A233	Automotive Masking	A342-A343	ScotchLok Auto-Taps	A300
Stabilo Pencils and Pens	A357			Silicone Sprays	A161



43AGR CATALOG A TO Z PRODUCT INDEX

Single Step Primer	A123	Truck		Utility Blade Dispensers	A179, A366
Spray Adhesives	A139	Bed Glass Carriers	A208-A211	Utility Knives and Blades	A176-A177, A366
Spray Lubricant	A161	Cap Accessories	A447-A449	UV	
Strip-Calk	A125	Locking Strip Tools	A310-A312	Blocker	A113
Structural Adhesive	A135	Rack Cushion	A209	Curing Lamps	A221
Super Fast Urethane	A122	Racks	A208-A211	Resins	A217, A220, A223
Super Weatherstrip Adhesive	A133, A229, A319	Rear Sliders	A399-A441		
Tapes	A342-A343, A348	Slider Application Charts	A434-A441	V	
Trizact Discs	A230-A231	Slider General Information	A399-A403	V-Rack	A210
Trizact Scratch Remover Kit	A230	Slider Installation Video	A442	Vac, Wet/Dry	A385
Urethanes and Primer	A122-A123	Slider Latches	A443	Vaco	
Very High Bond Tape	A348	Slider Rear Gaskets	A442	Bull Drivers	A372
Weatherstrip Adhesive	A133, A229	Tube Wax	A163, A360	Hex Nut Driver Set	A376
Windo-Weld Butyl Tape	A125	Tuff-Pak Tape	A345	Metric Nut Driver	A376
Windo-Weld Resealant	A128	Two Drawer Tool Chest	A349	Vacuum Cups	
Windo-Weld Sealer	A132	Two-Piece Self-Sealing Weatherstrips	A307-A308	All Rubber	A205
Windshield Adhesive	A122-A123			Automotive	A204-A206
Windshield Tape, Deluxe	A343	U		Cross Handle	A387
Woodgrain and Stripe Adhesive Remover	A152	"U" Blade Knife	A173	Double Cup	A387
Ties, Nylon Cable	A299	Ultra Low Viscosity Crack Resin	A223	Double Swivel	A206
Tightwire Grips	A183	UltraOne Adjustable Cut-Out Knife	A170	Glass Handling	A204-A206, A386-A387
Time Saver Blades	A186	Ultrasonic Leak Detector	A181	Handi-Grip	A204
Tips, Adhesive Gun	A147	Ultraviolet Curing Lamps	A221	Heavy-Duty	A387
Titan Urethanes and Primers	A118-A119	UltraWiz Cut-Out Blades	A171	Lever-Actuated	A387
Tool		UltraWiz Cut-Out Knives	A170	Powr-Grip	A205, A386
Apron	A394	Unbeaded Glass Run Channel	A322-A325, A328-A331	Pump-Activated	A204-A205, A386
Bags	A352	Underseal Undercoat Spray	A139	Rubber	A205
Basket	A352	Underside Molding	A340	Single Cup	A387
Boxes and Chests	A349-A350	Unibit Step Drills	A371	Single Lever	A204
Carriers	A351-A352	Unishear, Bosch	A384, A459	Triple Cup	A387
Holders and Pouches	A351	Universal		Wood's	A204-A205, A386
Tooling Sticks	A312	Bottom Channel	A331	Van	
Top Rails	A448	Channel Moldings	A338-A339	Accessories	A494-A495
Toplife Glass Cutters	A354	Chrome Molding	A339	All Glass Look Windows	A466, A470-A471, A474, A478
Torx		Door Glass Brackets	A277	Bay Windows	A470-A482, A484-A489
Bits	A374	Flat Surface Windows	A483	Commuter Windows	A499-A500
Key Sets	A376	Molding Application Chart	A339	Door Windows	A470-A479, A481-A482, A490-A493
Wrench	A373	Trim Tool, 10-in-1	A273	Half-Sliders	A472-A473, A477, A481-A483, A485, A492-A493
Towels	A158-A159	Trunk Seal	A321	Locking Strip Tool	A311
Toyota		Windshield Molding	A341	Minivan Windows	A473, A477, A480-A481
Cowl Fasteners	A265-A266	Upholstery		Portholes	A494
Trim Panel Fastener	A272	Fasteners	A293	Sunroof	A494
Truck Sliders	A429, A432-A433, A438-A439	Nail Remover	A276	Universal Windows	A483, A485-A487, A489
Windshield Molding Clips	A250-A252	Tools	A273-A276	Vents	A494
TPC Surface Protector	A150	Urethane		Window Measurement Guide	A468-A469
Trailer Windows	A496-A497	Adhesives	A110-A123	Windows	A466-A493
Transit Van Windows	A499-A500	Cartridge Holder and Opener	A144	Vent Glass Tools	A278
Translucent Tapes	A348	Comparison Charts	A106-A108	Vents, Van	A494
Transparent Tapes	A348	CRL	A110-A114	Vertical	
Tridon Windshield Wiper Blades	A238	Cut-Out Knives	A168, A170, A174-A175, A184-A185, A188, A190-A193, A196, A199-A200	Bulb Seal	A314-A315
Tri-Vent Sliders		Duramix	A134	Fin Seal	A315
Chevy/GMC	A413-A415, A417, A436	Essex	A120-A121	Leg Seal	A314
Dodge	A421-A424, A437	Hand Cleaners	A156-A157	Lift Sliders	A483, A486
Ford	A405-A408, A410, A435	Heated	A114, A116	Lip Seal	A315
Isuzu	A431-A432, A440	Heater Ovens	A115	Wedge Seal	A313
Mazda	A431-A432, A440	High Modulus Comparison	A108	Very Hi-Bond Adhesive Tapes	A348
Mitsubishi	A432, A441	High Viscosity Comparison	A106	Video Tapes	
Nissan/Datsun	A430, A432, A439	Installation Information	A102-A105	Aegis Instruction	A218
Toyota	A429, A432, A438	Low-Conductive Comparison	A108	BTB Training	A192
Trim		Medium Viscosity Comparison	A107	Clear Vac Training	A215
Adhesive	A133, A139	Non-Conductive Comparison	A108	Extractor Tool Instruction	A191
Fastener Release Tools	A273	Nozzle Cutters	A144	Fein Knife Instruction	A198
Moldings, Windshield	A338-A341	Nozzles	A145	Truck Slider Installation	A442
Panel Fasteners	A268-A272	POWR Primerless	A112-A113	Vinyl Trim Adhesives	A133
QuickEdge	A316-A317	Primers	A111, A113, A117-A118, A121, A123	Vise, Automotive Side Window	A279
Rings, Sunroof	A457	Sika	A116-A117	Vise, Bench	A381
Seals	A313-A315	3M	A122-A123		
Securing Tape	A342-A343	Titan	A118-A119		
Triple Vacuum Cup	A387	Tube Opener	A144		
Trizact Scratch Removal System	A230-A231				



ASSISTANCE IN FINDING PRODUCTS



Supplying the World with Glazing, Architectural, Construction, Industrial, and Automotive Supplies

C. R. Laurence Co., Inc. An ISO9000 Company

There Are Many Ways to Find Just the Right Product for Any Job, and We Are Here to Help

C.R. Laurence Co. Inc. 2503 E. Vernon Ave. Los Angeles, California 90058-1897	
Toll Free Phone	(800) 421-6144
Toll Free Fax	(800) 262-3299
International Phone	(323) 588-1281
International Fax	(323) 581-6522



Send E-Mail To askus@crlaurence.com

You've looked through our catalog and tried the A to Z Index on our web site, and still couldn't find what you were looking for? Don't give up, just ask us for assistance by e-mail. Send your request to askus@crlaurence.com and our B-to-B Customer Service Department will respond with an answer, usually within one hour if you contact us during normal business hours. Any extra information (drawings, photos, dimensions, etc.) you can include in your e-mail is always appreciated. We will do our best to help you because your satisfaction is our goal.



Call Us Toll Free At (800) 421-6144

There's a friendly and helpful voice to help with your product inquiries whenever you call us toll free at (800) 421-6144 from anywhere in the United States or Canada. Please ask for Customer Service and let us know what you are looking for, how many you need, and when you need them. We're experts at searching available sources worldwide. The experience gained by decades of service affords us the ability to serve you in more ways than you might realize.



Fax Us Toll Free At (800) 262-3299

Our new fax server is waiting for your drawings, diagrams, and parts lists. They say a picture is worth a thousand words, and when you can send us a fax describing what you need it makes it that much easier to serve you. CRL offers toll free fax service from anywhere in the United States and Canada. Just dial (800) 262-3299, and address your request to CRL Customer Service. Make sure to include your name and return telephone number. We'll be in touch shortly with an answer.



Send Us A Sample

Need a special part but haven't been able to find it anywhere? We can usually help you by e-mail, phone or fax, but when that doesn't work, we offer a sample-matching service that is determined to serve you. Every year hundreds of CRL customers send us a samples of what they're looking for because they know that, quite often, CRL is their best chance of getting just what they need. You may send a sample of what you need to: CRL Customer Service, 2503 E. Vernon Avenue, Los Angeles, CA 90058-1897. Be sure to include your name and telephone number so we can call you with the results of our search.



LOG ON TO crlaurence.com FOR BUSINESS-TO-BUSINESS SERVICES

A516 | PHONE (800) 421-6144 | FAX (800) 262-3299 TOLL FREE FROM ANYWHERE IN THE U.S.A. OR CANADA



C.R. LAURENCE COMPANY

An ISO9001:2000 Certified Company

**43
AGR**

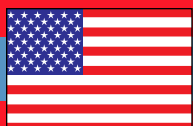

UNITED STATES

Corporate Headquarters

LOS ANGELES, CALIFORNIA

Phone: (323) 588-1281

Fax: (323) 581-6522

CHICAGO AREA, ILLINOIS

Phone: (847) 437-8320

Fax: (847) 437-8447

DENVER, COLORADO

Phone: (303) 373-9988

Fax: (303) 373-0884

NEW YORK CITY AREA

Phone: (201) 770-1077

Fax: (201) 770-1599

PHOENIX, ARIZONA

Phone: (602) 269-7500

Fax: (602) 269-7600

ATLANTA, GEORGIA

Phone: (404) 696-3445

Fax: (404) 696-3386

CLEVELAND AREA, OHIO

Phone: (440) 248-0003

Fax: (440) 248-0120

HOUSTON, TEXAS

Phone: (713) 462-6300

Fax: (713) 462-6306

ORLANDO, FLORIDA

Phone: (407) 857-7900

Fax: (407) 857-7766

SAN FRANCISCO / OAKLAND AREA

Phone: (510) 475-1000

Fax: (510) 475-1404

BOSTON AREA, MASSACHUSETTS

Phone: (508) 880-5600

Fax: (508) 880-5775

DALLAS, TEXAS

Phone: (214) 634-7305

Fax: (214) 631-6519

LAS VEGAS, NEVADA

Phone: (702) 253-0211

Fax: (702) 253-0311

PHILADELPHIA AREA

Phone: (856) 727-1022

Fax: (856) 727-3299

SEATTLE AREA, WASHINGTON

Phone: (253) 850-5800

Fax: (253) 813-1818



Corporate Headquarters

TORONTO AREA, ONTARIO

Phone: (905) 303-7966

Fax: (905) 303-7965

MONTREAL AREA, QUEBEC

Phone: (514) 352-3300

Fax: (514) 352-1017

CALGARY, ALBERTA

Phone: (403) 250-5783

Fax: (403) 291-3260

VANCOUVER AREA, B.C.

Phone: (604) 448-9344

Fax: (604) 448-9322



**CRL
EUROPE**

DUSSELDORF, GERMANY

Phone: (49) 2102 74 2838

Fax: (49) 2102 74 2834

**CRL
CANADA**



C.R. Laurence Corporate Headquarters in Los Angeles, California.

To Contact Us By E-Mail, Visit Our Web Site: crlaurence.com

To Contact Us From Anywhere in the U.S.A. and CANADA

CALL TOLL FREE (800) 421-6144 • FAX TOLL FREE (800) 262-3299

INTERNATIONAL PHONE: (323) 588-1281 • INTERNATIONAL FAX: (323) 581-6522

C.R. LAURENCE CO., INC.

Corporate Headquarters

Post Office Box 58923

Los Angeles, CA 90058-0923



All products F.O.B. nearest warehouse

© Copyright 2005, C.R. Laurence Co., Inc.