

Offer

Order

DE@crl.eu

Company, customer no:

Commission:

More info:

Choose system type (A1 - D):

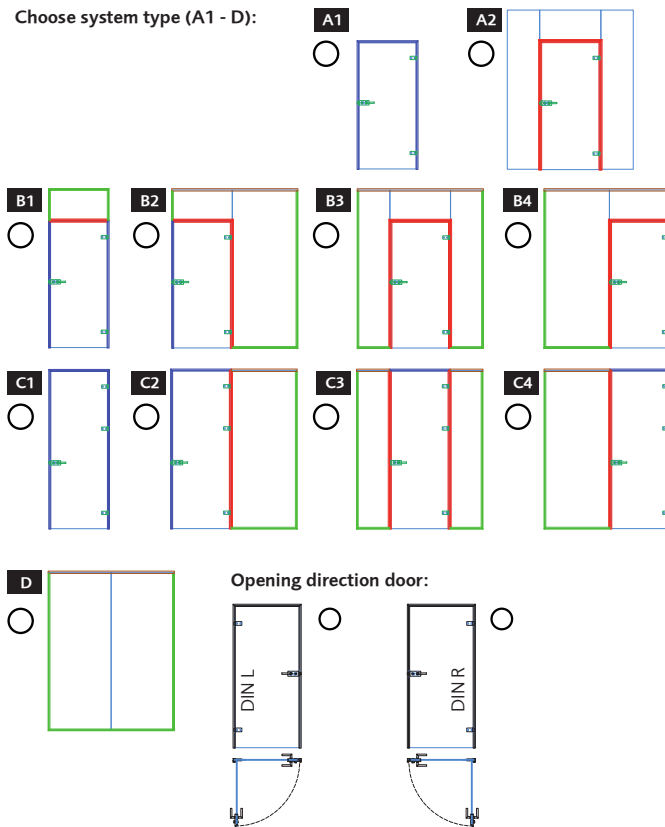

SYSTEM VIEW = REBATE SIDE = CLIP SIDE

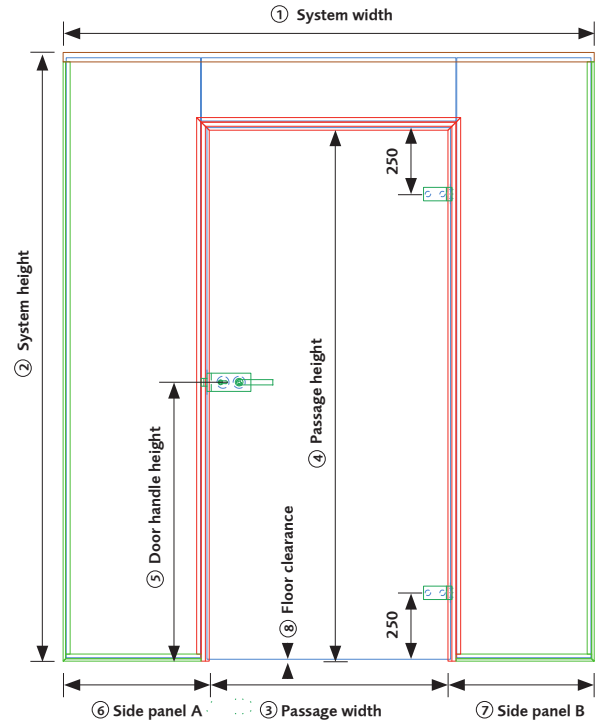

HORIZONTAL SECTION

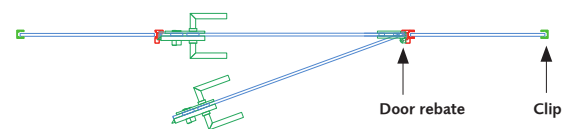

1. System width:

2. System height:

3. Passage width:

4. Passage height:

5. Door handle height:

6. Side panel A:

7. Side panel B:

8. Floor clearance:

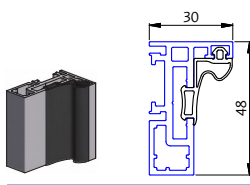

BASIS PROFILES

Door frame profile for wall connection

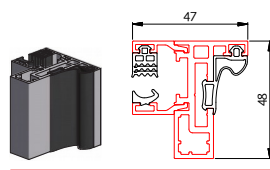

Door frame profile for glass connection

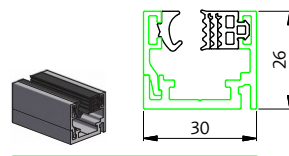

FRAME PROFILES

Frame
Fixed frame glazing profile for floor, wall and ceiling

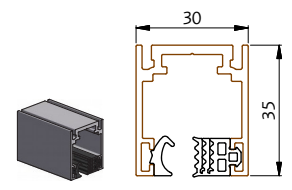

Top-Frame
Fixed frame glazing profile for ceiling

ELEMENT FINISHINGS:

- Drop-down seal
- Glass connecting strip clear

- Door: **Glass type** ESG VSG
Glass thickness 8 mm 10 mm 12 mm

- Fixed part: **Glass type** ESG VSG
Glass thickness 8 mm 10 mm 12 mm 16 mm

- Surface profile:** Satin anodized
 Black satin anodized
 Brushed nickle anodized
 RAL Silky gloss coated
 RAL Matt coated

- Colour gasket:** Black Grey

PLEASE SELECT DORMA FITTINGS SETS **OR** DORMA SINGLE FITTINGS

DORMA FITTINGS SETS:

- Surfaces:** Similar satin coated Similar brushed nickle coated Black matt coated

- Fittings set A**
Square, unlockable



2x

- Fittings set B**
Square, lockable
(prepared for profile cylinder)



2x

- Fittings set C**
Round, unlockable



2x

- Fittings set D**
Round, lockable
(prepared for profile cylinder)



2x

DORMA SINGLE FITTINGS:

- Surfaces:** Satin coated Brushed nickle coated RAL Coated Special color Anodized

Lock options:

- Lock function:** Unlockable Prepared for profile cylinder KABA prepared Closed on one side

- Lock types:** Office Junior Office Classic Studio Rondo Studio Classic



Hinge options:

- Hinge square  Hinge round 

Opening angle Dorma hinges approx. 140°
 Hinges for opening angles up to approx. 180° on request

Handle options:

- Handle square  Handle round 

DORMA hinges are not compatible with „regular doors“